

From Eye to Insight

*Leica*  
MICROSYSTEMS

THE FUTURE  
OF DIGITAL SURGERY  
IS HERE.

*ARveo 8 evolves continuously.*





# ARveo 8

## CONTINUOUSLY EVOLVES TO PUSH THE BOUNDARIES OF NEUROSURGERY

The ARveo 8 digital visualization microscope evolution continues. Get ready for a new level of continuous access to digital capabilities that are pushing the boundaries of neurosurgery as you know it.

The evolved ARveo 8 ecosystem now includes additional clinical 3D applications that will transform your vascular and brain tumor surgery. The all-in-one surgical visualization headset, MyVeo, will take you beyond what you've imagined.

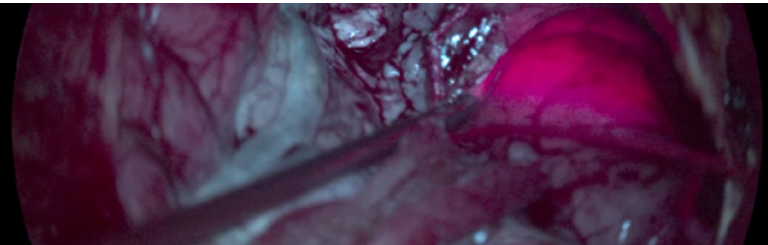

### A NEW LEVEL OF **CLINICAL VALUE CREATION**

All Leica AR applications are now available in 3D. See clear anatomical structures with the GLOW400 3D fluorescence application for brain tumor surgery.

> [pages 04-07](#)



### A NEW LEVEL OF **SURGICAL WORKFLOW EFFICIENCY**

Free yourself from the microscope with real-time clinical data in front of the eyes, helping you and your team to stay focused, comfortable, and connected.

> [pages 08-09](#)

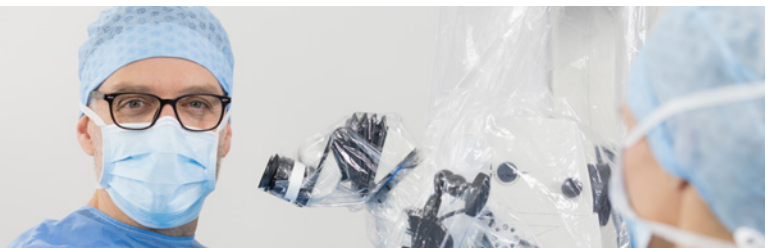
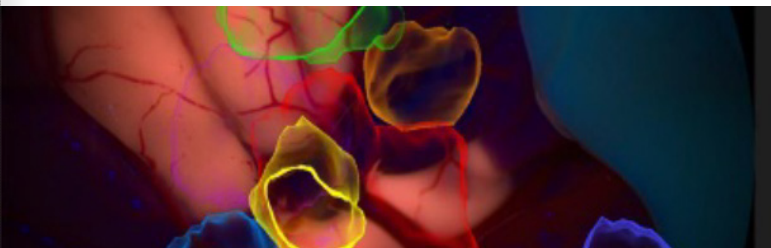

A NEW LEVEL OF  
**CONTINUOUS ACCESS**

Enjoy the freedom of ongoing access to clinical applications from Leica and new technologies to effortlessly advance your surgical expertise without having to replace your microscope.

> **pages 10-11**

A CONTINUED LEVEL OF  
**DIGITAL AND OPTICAL MICROSCOPE  
EXCELLENCE FOR YOUR NEEDS**

Rely on proven Leica surgical visualization and illumination features paired with digital capabilities for enhanced efficiency across your entire team.

> **pages 12-14**



## A NEW LEVEL OF **CLINICAL VALUE CREATION**

Augmenting your reality with 3D visualization technology and clinical applications of the GLOW Augmented Reality (AR) platform.

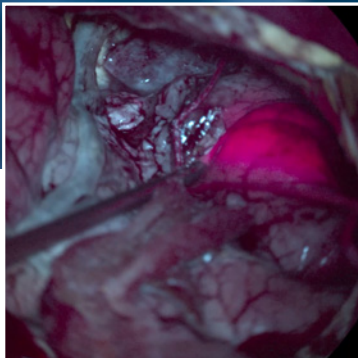

### **Transform your brain tumor surgery**

GLOW400 AR fluorescence for brain tumor surgery shows clearer anatomical structures and a wider range of intensities from fluorescently marked tissue during grade III and IV glioma surgeries. This will transform your brain tumor surgery, supporting you in taking more confident surgical decisions.



### **Augment your vascular neurosurgery**

GLOW800 AR fluorescence for neurovascular surgery shows the cerebral anatomy in natural color, augmented by real-time vascular flow with 3D AR depth perception in white light. You see a single view of anatomy and blood flow.



### **Experience 3D AR depth perception: on-screen and with the MyVeo surgical headset**

Digital visualization of the operating field in 3D high resolution enables the entire OR team to see state-of-the-art surgical 3D images in real time. It facilitates understanding of spatial information and allows everyone to follow the surgical course more easily.

# The Power and Potential of Multispectral Imaging Applications by Leica Microsystems

The GLOW800 and GLOW400 clinical applications of the GLOW AR platform are based on digital spectral detection augmenting structures and tissues with multiple spectral bands. The sophisticated imaging sensors and algorithms of GLOW AR acquire, optimize, and combine multiple spectral bands of light. The result is natural or bright coloring of the anatomy and accurate representation of fluorescence intensity in a high definition 3D image.

Whether you need to see vascular flow augmented in your white light microscope view or see clearer anatomical details surrounding the fluorescent-marked tumor, the clinical applications of the GLOW AR platform provide you and your entire team with real-time 3D AR views for confident, precise and well-informed surgical decision-making.

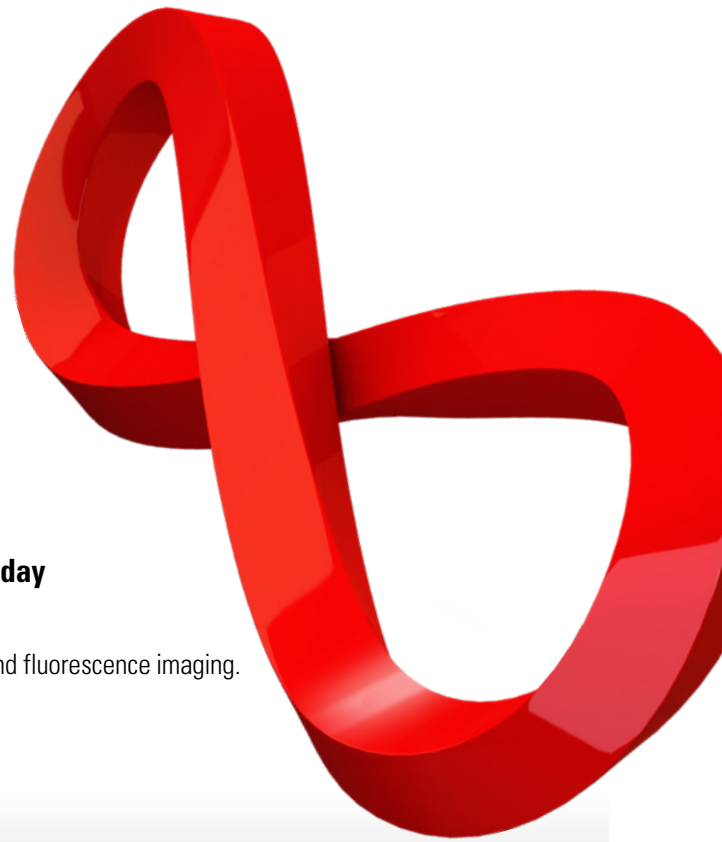

## ■ There's so much more to look at than what we can see today

The possibilities are infinite, which is why we will continue expanding our clinical applications of the GLOW AR platform, based on multispectral and fluorescence imaging.

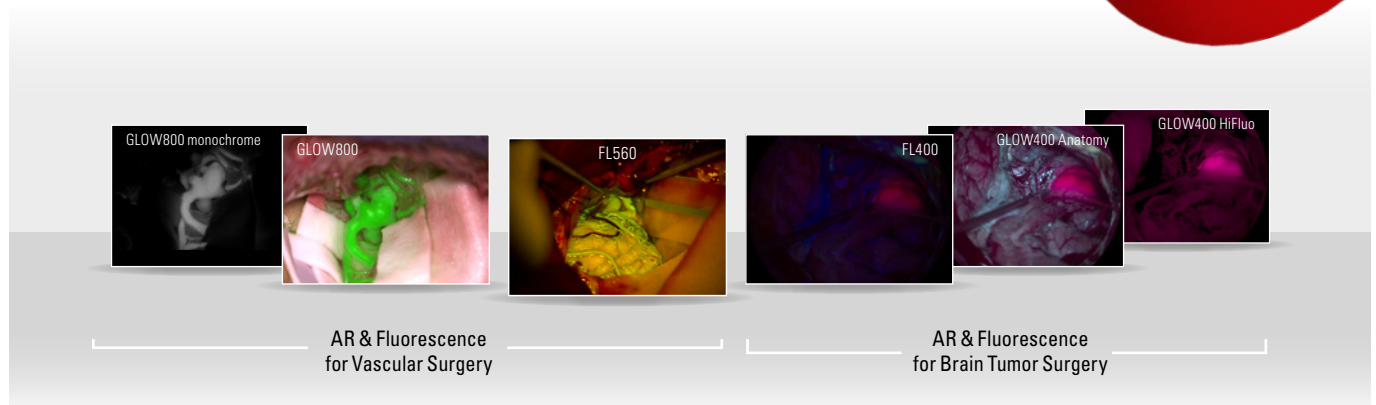

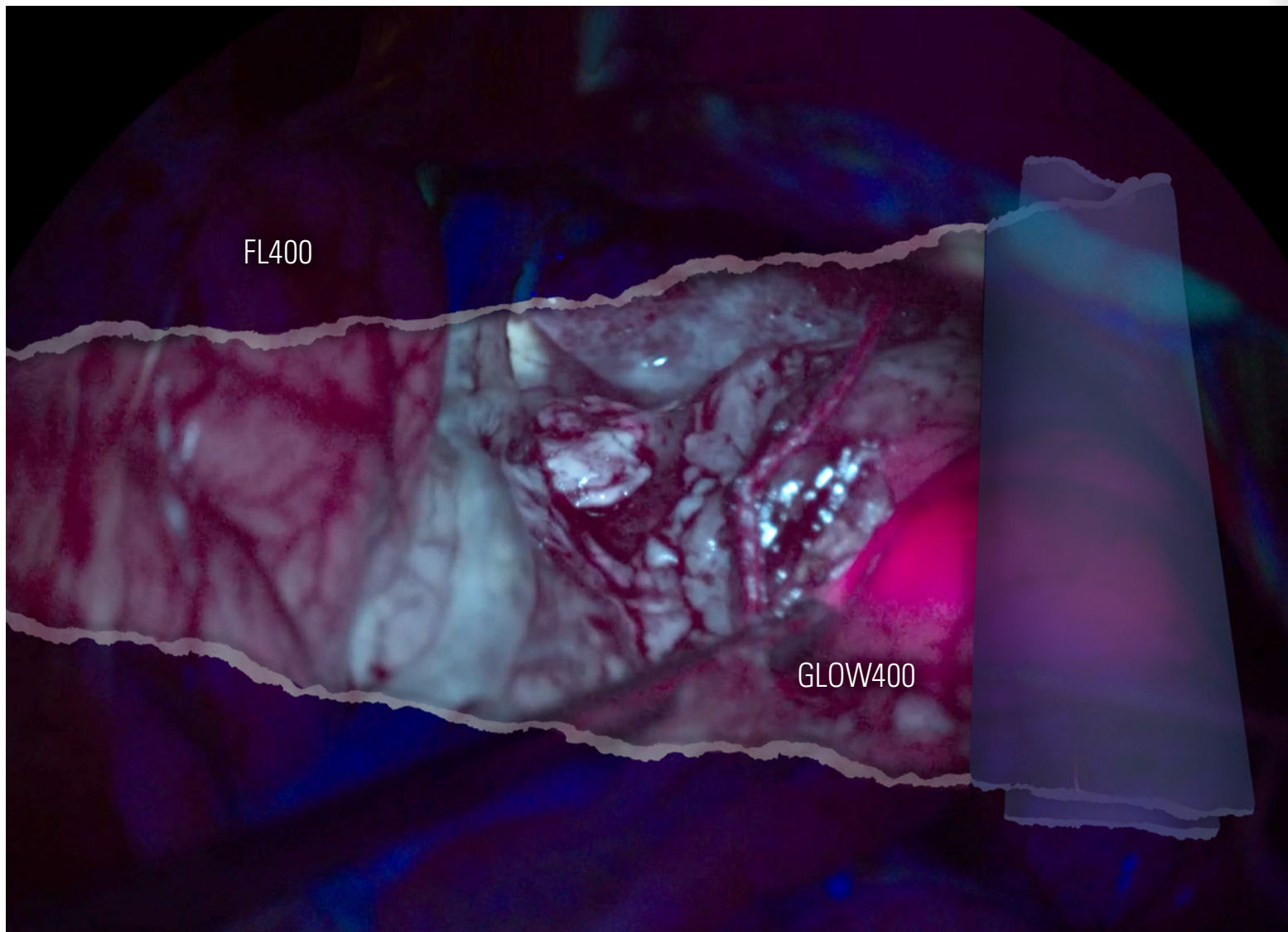

## GLOW400

### Transform your Brain Tumor Visualization

The GLOW400 Augmented Reality (AR) fluorescence application for brain tumor surgery is taking visualization of suspected grade III and IV gliomas to another level. With advanced multispectral imaging from Leica Microsystems, GLOW400 provides new insights that transform tumor visualization by allowing you to see details previously hidden under a veil of blue light.

Stay focused and make more confident surgical decisions by seeing clearer anatomical details in the Anatomy view and observing a wider range of fluorescent intensities in the Highlighted Fluorescence view.

GLOW400 utilizes the illumination and observation filters of the FL400 blue light fluorescence application and is fully compatible with the ARveo 8 digital visualization microscope. The digital real-time fluorescence images can be shown in high resolution in 2D or 3D, on a large 55-inch monitor, as well as directly in front of your eyes with MyVeo all-in-one surgical headset.

# Real-Time Views of GLOW400

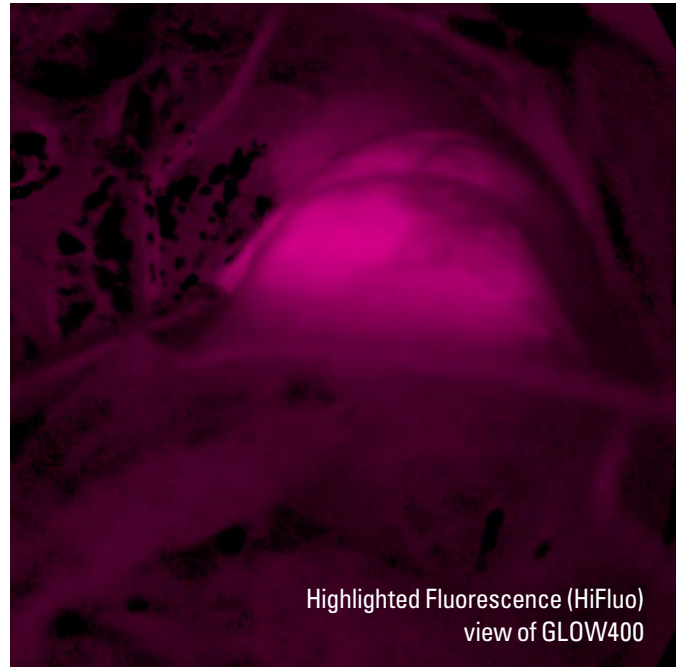
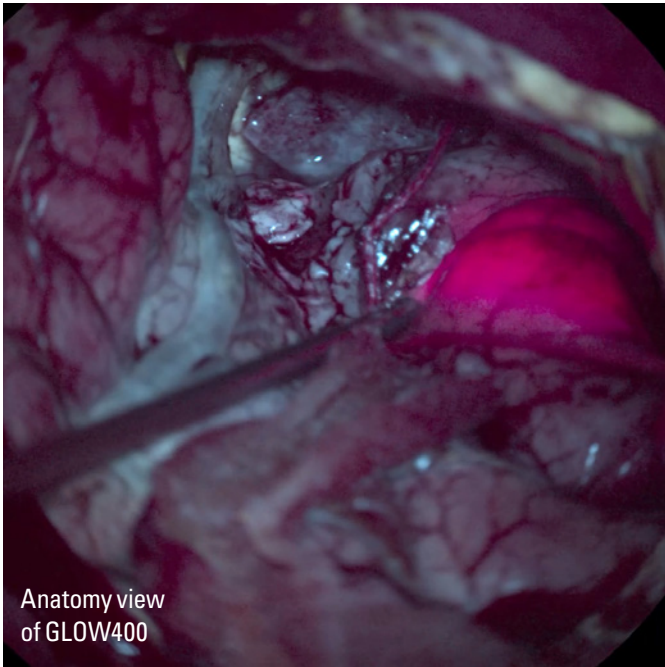

All GLOW400 images shown here are courtesy of Tim Jacquesson, MD, PhD Hospices Civils de Lyon, France.

## ■ See clearer anatomical details surrounding the fluorescence-marked tumor

The GLOW400 Anatomy view gives you a comprehensive enhanced picture of fluorescent and non-fluorescent tissue. Have a clearer view of anatomical details, including vessels and views of bleeding—all in real time.

## ■ Reveal lower-intensity fluorescence signals

The GLOW400 Highlighted Fluorescence view shows traces of remaining visible fluorescence of suspected grade III and IV glioma tissues. The pure view of fluorescence delivers a broader representation of fluorescence intensities, revealing traces that you may have missed before.

## ■ Get a more comprehensive understanding

Utilize different views to gain a comprehensive visualization of the suspected grade III and grade IV glioma tissues.

Mono or side-by-side views help you evaluate your surgical course of action.

GLOW400 may reduce surgical interruption and mental fatigue, as you don't need to switch between the white light and FL400.

## TOGGLE THROUGH MULTIPLE REAL-TIME GLOW400 VIEWS



### Mono views

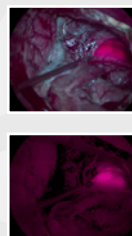

### Side-by-side view

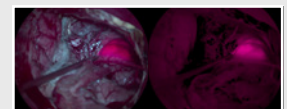

You can visualize the GLOW400 AR application live on a 2D or 3D monitor in the OR. If you want to have everything directly in front of your eyes, choose the MyVeo all-in-one surgical visualization headset.



## A NEW LEVEL OF **SURGICAL WORKFLOW EFFICIENCY**

Free yourself from the microscope with real-time clinical data in front of the eyes in 3D, helping you and your team to stay focused, comfortable, and connected with the all-in-one surgical visualization headset MyVeo.





### ■ Stay focused

Experience uninterrupted workflow by not having to look at multiple monitors for the digital information required for clinical decision-making. Access a broad spectrum of surgical information in a single integrated real-time 3D view directly in front of your eyes.\*

### ■ Increase comfort

Freed from oculars and external monitors, you can experience more ergonomic comfort and freedom of movement, especially beneficial during long surgeries. Up to three MyVeo users can simultaneously benefit from live surgery visualization via the headset.

### ■ Boost collaboration

With MyVeo, you can experience the exact same 3D view as the main surgeon in real-time, high-resolution 3D. The headset offers an amazingly generous peripheral field of view, allowing you to see your hands, instruments and interact with your team as usual.

\* Applications from external systems, such as IGS or information from compatible endoscopic video systems are only displayed in 2D resolution.



## A NEW LEVEL OF **CONTINUOUS ACCESS**

Enjoy the flexibility to use different viewing options as it suits you. With Leica, you also have the assurance of ongoing access to new clinical applications and new technologies to easily expand your surgical expertise without having to replace your microscope.



Traditional oculars



3D heads-up screen



MyVeO all-in-one surgical visualization headsets

### ■ Adapt to any new viewing option at your own pace

Freely select from three interchangeable viewing options: choose traditional oculars\*, 3D heads-up monitors, or the most advanced MyVeO headset. You also have the flexibility to use each viewing option interchangeably.

\*Ocular view does not show GLOW AR views

## ■ Access the latest technology without replacing the microscope

The EnhancePath concept, an essential part of the ARveo 8 ecosystem, allows you to seamlessly evolve into the future of digital surgery. This concept provides continuous access to the latest Leica surgical and digital viewing technologies, as well as an easy way to implement advanced clinical applications on your current ARveo 8 microscope.

# EnhancePath

## ■ Easily connect to compatible surgical devices

The ability to combine preoperative images with intraoperative imaging can be essential during procedures. You can use image-guided surgery (IGS) systems to augment your microscope view by adding anatomical and functional data onto your microscope's white light and the fluorescence view. The ARveo 8 is compatible with neuro-navigation systems of leading manufacturers.

You can add even more layers of information by complementing your microscope view with a video system feed of a KARL STORZ video system.

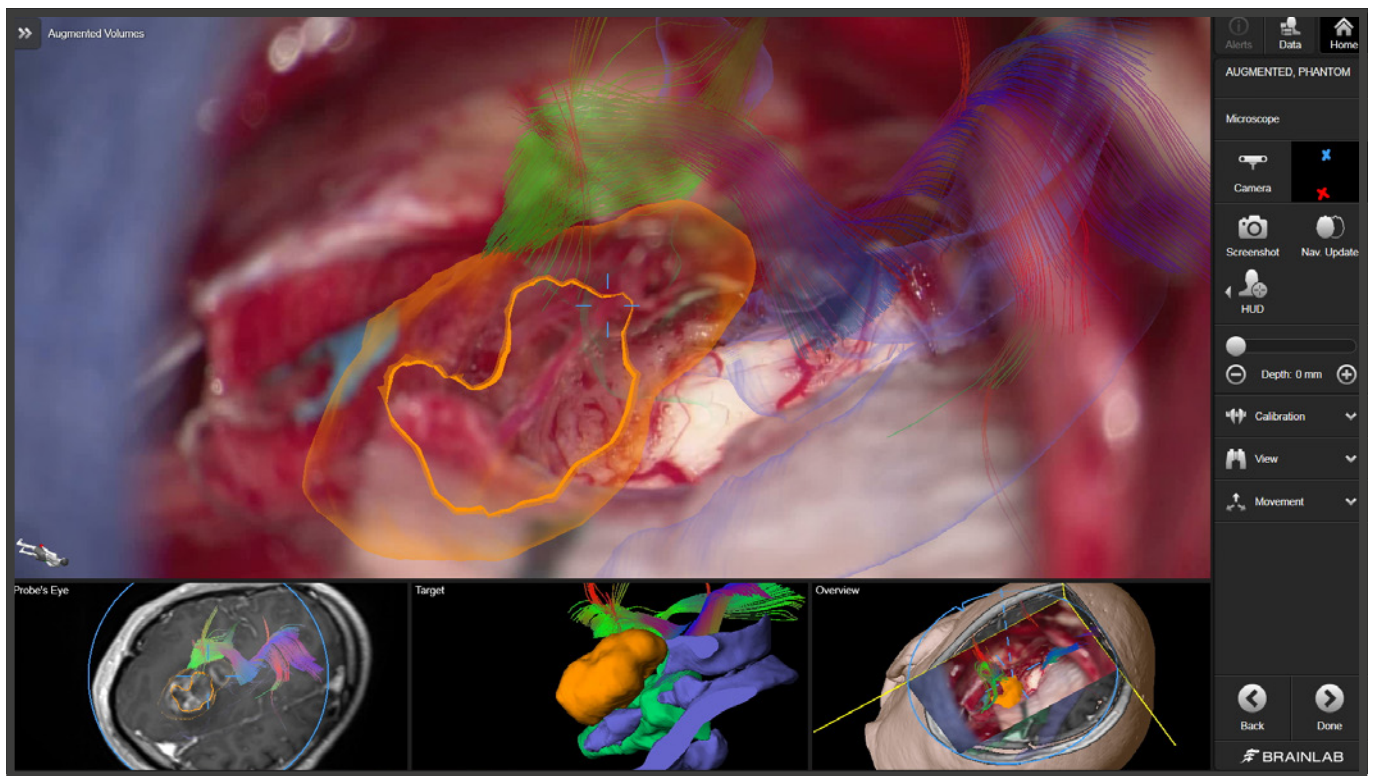

## Support during intraoperative assessment: align and view with ease

- > Update image realignment during surgery using the microscope image
- > View information more ergonomically with picture-in-picture navigation options
- > Get support when assessing critical areas due to visualization of planned structures as semi-transparent volumes combined with a virtual 360-degree target view

## Robotic alignment of the microscope's optics carrier via the Brainlab IGS system

- > Keep your image in focus during the entire neurosurgery, thanks to the tip focus function of the latest cranial navigation software from BrainLab
- > Rest assured that you always have a centered view in spite of microscope movement thanks to the "follow tip" or "move to pin" functions



## A CONTINUED LEVEL OF **DIGITAL AND OPTICAL EXCELLENCE FOR YOUR NEEDS**

Rely on proven Leica surgical visualization and illumination features paired with digital capabilities for enhanced efficiency across the entire team.

### ■ **Experience enhanced efficiency across different procedures**

The ARveo 8 surgical microscope is amazingly versatile. This is based on the microscope's great range of movement, large working distance, tilting range of the optics carrier, and an extensive overhead reach.

In addition, ARveo 8 features integrated illumination functions that help protect sensitive tissue during surgical procedures.

Built-in BrightCare Plus automatically optimizes light intensity relative to the working distance to minimize tissue burns.

The Auto Iris function automatically adjusts the diaphragm so that only the visible area is illuminated. This prevents the possibility of drying or burning exposed tissue outside of the field of view.

Another aspect of the versatility of the ARveo 8 lies in the multiple visualization options as well as easy-to-use microscope functions, for setup and operation.

Quick balancing function for intraoperative use

Long overhead reach for flexible positioning

31-inch 4K 3D microscope-mounted monitor  
Optional: 55-inch 4K 3D external cart-mounted monitor

Convenient drape air removal system

MyVeO all-in-one surgical visualization headset

Manually fine adjustable handles

More space to work (600 mm)

2-in-1 image display system: Microscope and imaging GUI

Effortless operation via handles or wireless footswitch

Premium stand by Mitaka

## ■ Benefit from one graphical user interface for microscope operation and image acquisition

The ARveo 8 graphical user interface (GUI) is designed to be self-explanatory for all members of the OR team.

It guides you through setting up of the microscope, allows for intraoperative adjustments on the fly, and enables image acquisition and transfer. It also serves as an additional monitor to show the microscope image.

## ■ Easy setup

- > Select and define different user roles and rights
- > Password protect default configurations and individual user settings, e.g., GLOW800 visualization
- > Increased cybersecurity with secured patient and user data

## ■ Easy recording

- > Record videos and images in 2D or 3D quality utilizing a high-compression 2 TB storage space
- > Quickly store images and export via USB and ethernet to your hospital network
- > Optimized data processing and connectivity for PACS and DICOM

■ **Experience enhanced optical image quality**

Enjoy the best of two worlds for a significantly expanded area in full focus and less refocusing.



1. Two separate optical paths
2. One path provides great depth of field
3. The other path provides high resolution
4. The brain effortlessly merges the images into a single, optimal spatial view



Magnification multiplier for 40% boost



SpeedSpot for fast focusing



Fine focus for rear assistant

For too long, surgeons had to compromise between high resolution and greater depth of field – no more! FusionOptics technology captures different information from each beam path, delivering the highest possible resolution to the left eye and maximum depth of field to the right. The brain then easily merges the information into a single, sharp image with a significantly larger depth of field. And what's more, less refocusing helps streamline your workflow.

■ **Everything is illuminated**

The more you know, the more empowered you become to make the right decisions for your patients. Small Angle Illumination (SAI) combined with bright 400 W Xenon illumination allows light to penetrate to the bottom of deep, narrow cavities.



Without SAI  
(400 mm working distance)



With SAI  
(400 mm working distance)

■ **Visualization that adapts to you**

- > The optional magnification multiplier boosts magnification by 40%
- > SpeedSpot uses two laser beams acting as a focusing reference to quickly provide a defined focus point for all viewing positions (surgeon, assistant, and camera)
- > Your rear assistant has an independent fine focus
- > A range of binoculars are available, all adjustable to different heights and positioning due to full 360°-rotation

# TECHNICAL SPECIFICATIONS

## OPTICS AND ILLUMINATION

FusionOptics	For increased depth of field and high resolution for the main surgeon
Objective lens	Apochromatic
Magnification	6:1 zoom, motorized optional magnification multiplier
Objective / working distance	225–600 mm, motorized multifocal lens, continuously adjustable with manual adjustment option
Eyepieces	Wide-field eyepieces for persons wearing glasses
Observation	Full stereo view for main surgeon and opposite assistant, semi stereo view for two side assistants
Integrated 360° rotatable adapter	For main surgeon and opposite assistant binoculars
SpeedSpot	Laser focusing aid for fast and exact positioning of the microscope
Illumination	<ul style="list-style-type: none"> <li>- Two 400-Watt Xenon arc-lamp systems with independent power supply</li> <li>- Light transmission via fiber optics cable</li> <li>- Continuously variable illumination field diameter</li> <li>- Continuously adjustable brightness at constant color temperature</li> <li>- Automatic activation of second illumination</li> </ul>
Autoliris	Built-in automatic, zoom-synchronized illumination field diameter, with manual override and reset feature
BrightCare Plus	Safety function through working distance-dependant limitation of the brightness, controlled by built-in luxmeter

## MANEUVERABILITY AND CONTROL

Robotic function	<ul style="list-style-type: none"> <li>- Motorized XY movement</li> <li>- Externally controllable (optional)</li> </ul>
Control	- Programmable handles
Balancing	<ul style="list-style-type: none"> <li>- Automatic balancing of stand and optics</li> <li>- Automatic intraoperative balancing</li> <li>- Manual fine balancing</li> </ul>
Microscope carrier	“Advanced Movement” system for balancing six axes and vibration damping technology
Carrier for monitor	Flexible arm with four axis for rotation and inclination

## MODULAR OPTIONS

GLOW800 Augmented Reality fluorescence	<ul style="list-style-type: none"> <li>- Fluorescence excitation 790 nm</li> <li>- Fluorescence signal 835 nm</li> <li>- Two 1/1.2" high sensitivity HD cameras for white light imaging</li> <li>- Two 1/1.2" high sensitivity HD cameras for fluorescence imaging (NIR)</li> <li>- 2D and 3D visualization</li> </ul>
GLOW400 Augmented Reality fluorescence	<ul style="list-style-type: none"> <li>- Fluorescence excitation: Peak of ~380 – ~430 nm (blue)</li> <li>- Fluorescence signal ≥ 444 nm</li> <li>- Four 1/1.2" high sensitivity HD cameras for fluorescence imaging (two for each channel)</li> <li>- 2D and 3D visualization</li> </ul>
FL400 fluorescence	FL400 blue light fluorescence module
FL560 fluorescence	FL560 fluorescence module
2D/3D video options	<ul style="list-style-type: none"> <li>- 4K HD 27-inch monitor</li> <li>- 4K 3D 31-inch monitor on microscope</li> <li>- 4K 3D optional 55-inch monitor cart system</li> <li>- Integrated auto focus</li> <li>- 3 digital zoom levels</li> <li>- integrated 4K upscaling software via HDSI-connector</li> </ul>
MyVeo	<ul style="list-style-type: none"> <li>- All-in-one surgical visualization headset compatible with the ARveo 8 surgical microscope</li> <li>- High resolution displays (Full HD) for each eye</li> <li>- For up to 3 viewers simultaneously, individual control of image orientation and brightness</li> <li>- Cable connection of 5.2 meters between the MyVeo user and the MyVeo hub-box on the microscope</li> </ul>
OpenArchitecture*	- Easy integration of IGS systems and video system feeds from Karl Storz
Leica Recording System	<ul style="list-style-type: none"> <li>- Fully integrated 2D and/or 3D recording</li> <li>- DICOM/PACS integration</li> </ul>
Universal drape air removal with SMARS*	<ul style="list-style-type: none"> <li>- One-button drape air removal system</li> <li>- Compatible with surgical microscope drapes</li> </ul>
Additional controls	<ul style="list-style-type: none"> <li>- Mouthswitch to activate multi-directional movement</li> <li>- 12-function wireless footswitch</li> </ul>
Cyber Security	<ul style="list-style-type: none"> <li>- MDS2 Medical Device Security</li> <li>- comply with international standard such as ANSI/UL</li> </ul>

## TECHNICAL DATA

Power connection ARveo 8 Protection class	<ul style="list-style-type: none"> <li>- 1300 VA 50/60 Hz</li> <li>- 100 V - 240 V / 50 - 60 Hz</li> <li>- Class 1</li> </ul>
Materials	- Entire solid metal construction coated with a paint which is designed to provide an antimicrobial effect on surfaces
Load	<ul style="list-style-type: none"> <li>- Swing arm: min. 6.7 kg, max. 12.2 kg from microscope dovetail ring interface</li> <li>- Monitor arm: max. 16kg</li> </ul>
Weight	- Approx. 320 kg without load

\* Please contact your local sales representative for more information

# ARveo 8 Overhead Stand Dimensions

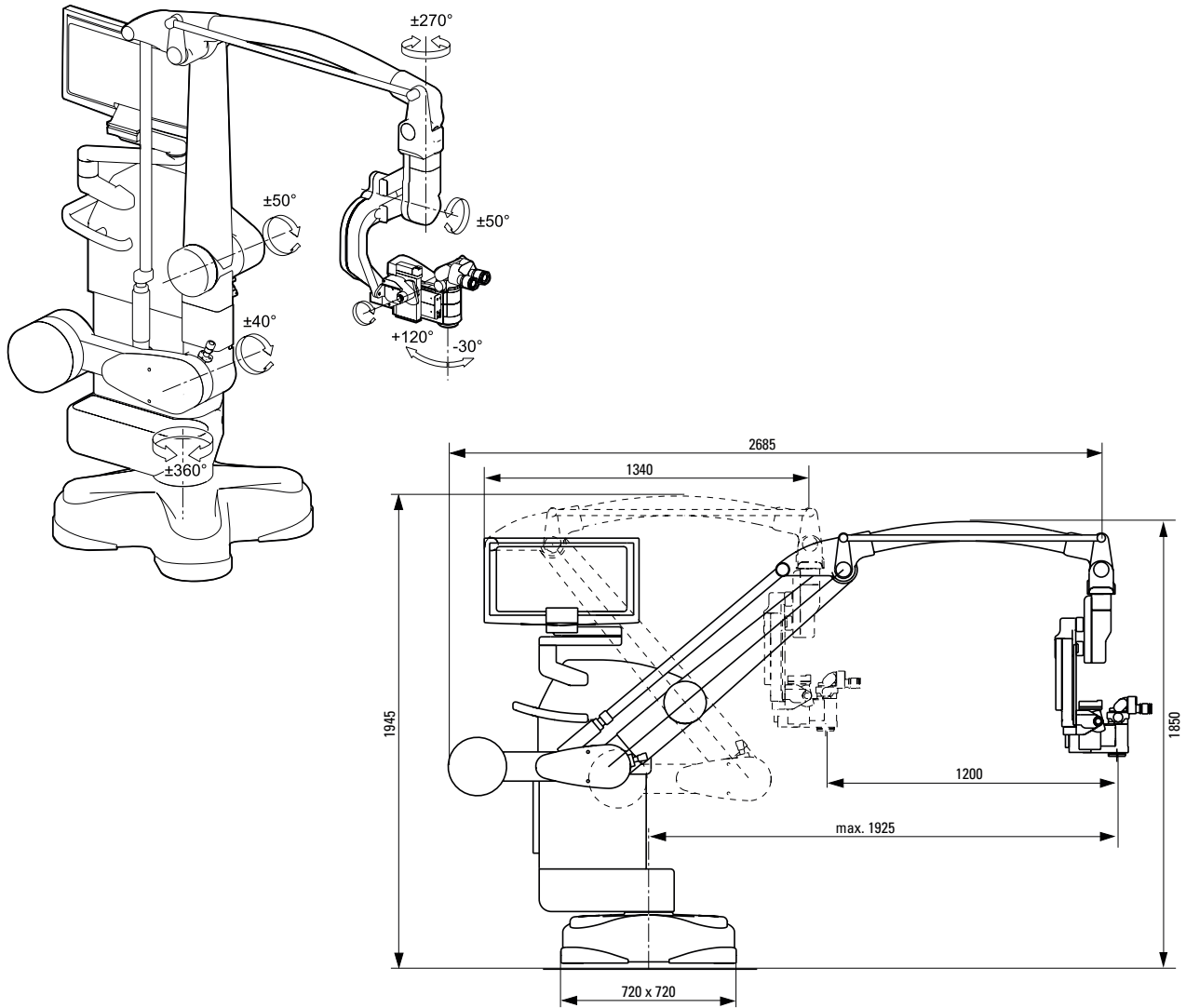

MC-0006533 - 05.01.2024 - EN - Copyright © 2024 by Leica Microsystems (Schweiz) AG · LEICA and the Leica Logo are registered trademarks of Leica Microsystems IR GmbH. Other trademarks shown herein are the property of their respective owners.



Leica Microsystems (Schweiz) AG  
 Max Schmidheiny-Strasse 201  
 9435 Heerbrugg, Switzerland



Class IIa GLOW400 and GLOW800

Class I surgical microscope ARveo 8 incl. accessories, such as MyVeo

Note for customers from the United States of America:  
 FDA 510(k) clearance for GLOW400 is pending and the product is currently not available for sale.

Not all products or services are approved or offered in every market and approved labeling and instructions may vary between countries.  
 Please contact your local Leica representative for details.



Leica Microsystems (Schweiz) AG · Max Schmidheiny-Str. 201 · 9435 Heerbrugg ·  
 Switzerland · T +41 71 726 3333

[www.leica-microsystems.com](http://www.leica-microsystems.com)



CONNECT WITH US!

