

# Surgical Product Catalog









## ORDERING

Call toll free 1.(800) 979.2020 US and Canada  
(610) 889.0200 International  
+31 (0) 485.350300 Europe  
Fax: (610) 889.3233  
[info@accutome.com](mailto:info@accutome.com)



3222 Phoenixville Pike, Building #50 • Malvern, PA 19355 USA  
European Office: Simon Homburgstraat 21 • 5431 NN, Cuijk, NL

# About Us

Accutome is entering our fourth decade in the ophthalmic industry. The three major traits that keep the Accutome brand growing remain the same: superior customer service, quality, innovation. It is our goal to make every experience you have with us special and productive.

Our focus is to continue to improve our product line and customer service to better suit your needs. We are constantly adding more customer service and sales representatives to provide worldwide support. We also have a European office in the Netherlands.

We have become a total solutions provider for all of your ophthalmic needs by supplying quality products such as office medications, supplies, surgical instruments, and diagnostic equipment. We carry thousands of products to meet your needs. If you do not see a particular item, give our representatives a call, and we will find it for you.

## Accutome Surgical Instruments and Supplies

Accutome offers a full line of diamond and metal surgical blades along with handheld surgical instruments and surgical disposable products. We are one of the top production and repair facilities of diamond knives. We cross-reference and competitively bid on all major brands of ophthalmic instruments - just send us your list for a quote.

Our reputation for innovation has been developed based on our relationships with top surgeons. Do you have an idea for a new instrument? Give us a call to discuss your idea.

## Accutome Repair Center

Our state-of-the-art repair and technical support center is staffed by highly trained technicians. We offer expert repairs on all brands of ophthalmic surgery instruments and ultrasound. We are also experts in diamond knife repair, having one of the largest diamond repair facilities in the U.S. Accutome can customize diamond blades to your specifications and the Diamond Exchange Program allows you to downsize existing blades for a low cost. Most brands and styles can be repaired by us, usually in 24 hours. Our instrument repair unit can sharpen or repair surgical instruments, making them like new.

## Accutome Diagnostic Equipment

Accutome offers a broad line of ophthalmic diagnostic equipment. We started in the 1980s by developing the first ophthalmic pachymeter. Today, we feature a full line of diagnostic equipment including: 4Sight, A-Scan Plus Connect, B-Scan Plus, UBM Plus, PachPen handheld pachymeter, AccuPach VI, and AccuPen handheld tonometer.

As an extension of our great customer service, Accutome also offers in-house diagnostic product specialists. Our specialists are available during work hours, Monday through Friday 8am to 8pm EST.

## Accutome Office Medications and Supplies

Accutome carries thousands of diagnostic pharmaceuticals and clinical exam supplies. There are no minimum order requirements, and most products ship out on the same day. We run quarterly specials on our most popular products, which can be found on our website at [www.accutome.com](http://www.accutome.com).

## ACCUSHARP DISPOSABLE OPHTHALMIC KNIVES

### NON-GUARDED DISPOSABLE OPHTHALMIC KNIVES .....12

AccuSharp Ophthalmic Angled Slit Knife.....	12
AccuSharp Ophthalmic Straight Knife.....	13
AccuSharp Ophthalmic Sideport/MVR Knife .....	13
AccuSharp Ophthalmic Crescent Knife .....	14
AccuSharp Ophthalmic Angled Implant Knife.....	14
Stab Knife .....	14

### GUARDED DISPOSABLE OPHTHALMIC KNIVES.....15

AccuSharp Guarded Ophthalmic Angled Slit Knife.....	15
AccuSharp Guarded Ophthalmic Straight Knife .....	15
AccuSharp Guarded Ophthalmic Sideport/MVR Knife .....	15
AccuSharp Guarded Ophthalmic Crescent Knife.....	16
AccuSharp Guarded Ophthalmic LRI Knife.....	16

## DIAMOND KNIVES

### PHACO INCISION DIAMOND KNIVES .....19

Simplicity Series .....	19
Simplicity Trapezoid Series .....	19
Dual Bevel Diamond Knife (Dual Sides Sharp) .....	20
Dual Bevel Diamond Knife (Four Sides Sharp) .....	21
Dual Bevel Trapezoid Diamond Knife .....	21

### SPECIALTY DIAMOND KNIVES .....22

Crescent Diamond Knife.....	22
Sclerostomy Diamond Knife.....	23
Universal Cataract Diamond Knife.....	23

### PARACENTESIS/STAB DIAMOND KNIVES.....23

Hawkeye Series .....	23
Hawkeye Premium Series .....	24

### ASTIGMATISM MANAGEMENT DIAMOND KNIVES.....25

Donnenfeld Preset LRI, Long Handle.....	25
Donnenfeld Preset LRI, Short Handle.....	25
Donnenfeld Preset Truncated Lancet, Long Handle .....	26
Donnenfeld Preset Truncated Lancet, Short Handle .....	26
Chang LRI Diamond Knife.....	27
Rubenstein Preset LRI, Long Handle.....	27
Rubenstein Preset Truncated Lancet, Long Handle .....	28
Rubenstein Preset LRI, Short Handle .....	28
Surgeon's Choice Adjustable .....	29
Micrometer .....	29

## SAPPHIRE KNIVES

### KERATOME SAPPHIRE KNIVES .....32

Clear Cornea Sapphire Knife .....	32
Spears Sapphire Knife .....	32
Trapezoid Sapphire Knife.....	32

### CRESCENT SAPPHIRE KNIVES .....33

Crescent Sapphire Knife.....	33
------------------------------	----

### SAPPHIRE STAB KNIVES.....33

Lancet Sapphire Knife .....	33
Single-Edge Sapphire Knife .....	33
Trifacet Sapphire Knife .....	33

## BIPOLAR INSTRUMENTS

### BIPOLAR CABLES & PROBES.....36

Bipolar Cables .....	36
Cautery Probe.....	36

### BIPOLAR FORCEPS .....36

Adson Bipolar Forceps.....	36
Coaptation Bipolar Forceps.....	37
Jewelers Bipolar Forceps .....	37
McPherson Bipolar Forceps.....	37
Shepard Bipolar Forceps .....	38

## CALIPERS, GAUGES & MARKERS

### CALIPERS .....40

Braunstein Fixed Caliper .....	40
Castroviejo Caliper.....	40
Jameson Caliper .....	40
Stahl Corneal Caliper .....	41

### GAUGES .....41

Mendez Degree Gauge.....	41
--------------------------	----

### MARKERS.....41

Bores Axis Marker .....	41
Chayet Marker .....	42
Dell LRI Astigmatism Marker.....	42
Devgan Axis Marker .....	43
Hoffer Optical Zone Marker.....	43
LASIK Corneal Marker.....	44
Osher-Neumann Radial Incision Marker .....	44
Plain Optical Zone Marker.....	45
Rubenstein LASIK Corneal Marker.....	45
Toric Lens Marker.....	45
Toric Reference Marker .....	46

## CANNULAS & CYSTOTOMES

### ACCUSURGICAL SINGLE-USE CANNULAS & CYSTOTOMES .....48

Atkinson Retrobulbar Needle .....	48
Atkinson Peribulbar Needle.....	48
Non Atkinson Retrobulbar Needle .....	48
Non Atkinson Peribulbar Needle .....	49
Sub Tenon Anesthesia Cannula .....	49
Rous Sub Tenon/Parabulbar Needle.....	50



Anterior Chamber Cannula, Angled .....	50	LASIK Cannula [Slade].....	74
Anterior Chamber Cannula, Straight .....	54	LASIK Cannula [Linn].....	74
Anterior Chamber Cannula, Curved .....	54	Refractive Cannula.....	74
Air Injection Cannula .....	55	Femtosecond Cannula [Solomon].....	75
Viscoelastic Cannula .....	55	Brody Femtosecond Dissecting Cannula .....	75
Thin Wall Anterior Chamber Cannula, Angled .....	55	AccuDrop Cannula .....	75
Thin Wall Anterior Chamber Cannula, Curved .....	56	<b>REUSABLE CANNULAS &amp; CYSTOTOMES.....</b>	<b>76</b>
Thin Wall Anterior Chamber Cannula, Straight .....	56	Atkinson Retrobulbar Needle .....	76
Double I/A Cannula .....	57	Air Injection Cannula .....	76
J-Shaped Double I/A Cannula.....	57	Gills-Welsh Aspirating Cannula .....	77
Double Barrel I/A Cannula [Simcoe] .....	57	McIntyre Anterior Chamber Cannula.....	78
Cortex Extractor [Charleux].....	57	McIntyre-Binkhorst Irrigating Cannula.....	79
Cortex Extractor [Simcoe] .....	58	Bishop-Harmon Irrigating Cannula.....	79
Button Coaxial I/A System .....	58	Bishop-Harmon Irrigating Cannula Bulb .....	80
J-Shaped Cannula .....	58	Adapter for Irrigators .....	80
J-Shaped Cannula [Binkhorst].....	59	Bishop-Harmon Irrigating Cannula Set .....	81
Micro J-Shaped Cannula [Hessburg] .....	59	Cystotome Cannula .....	81
Irrigating Cystotome.....	60	Lewicky Cystotome .....	81
Irrigating Double Sharp Cystotome [Kelman] .....	63	Hydrodissection Cannula .....	81
Irrigating Sharp Cystotome [Kelman] .....	64	Akahoshi II Hydrodissection Cannula.....	83
Capsule Polisher .....	64	Chang Nucleus Hydrodissection Cannula.....	83
Posterior Capsule Polisher .....	64	Simcoe Cortex Extractor Cannula .....	84
Silicone Tip Capsule Polisher .....	65	Infusion Cannula .....	84
Irrigating Vectis .....	65	Anis Cortex Aspirating Cannula.....	84
Bishop-Harmon Washout Cannula .....	65	Graether Collar Button Cannula .....	84
Nucleus Hydrodissection Cannula .....	66	Infusion Handle.....	85
Hydrodissection Cannula [Chang] .....	66	Henderson MICS Capsule Polisher Cannula.....	85
Hydrodissection Cannula [Kellan] .....	66	Jensen Capsule Polisher .....	86
J-Shaped Hydrodissection Cannula.....	67	Gills-Welsh Olive Tip Cannula .....	86
Hydrodelineation Needle [Kellan] .....	67	Lacrimal Cannula .....	86
Nucleus Hydrolysis Needle [P. Koch] .....	67	Bailey Lacrimal Cannula .....	87
Nucleus Hydrodissector/Rotator [Sinsky] .....	67	Fasanella Lacrimal Cannula .....	87
Cotrical Cleaving Hydrodissector .....	67	Simcoe I/A Cannula .....	88
Nucleus Hydrodissector .....	68	Slade LASIK Cannula .....	88
Lacrimal Cannula .....	68	<b>CAPSULE POLISHERS</b>	
Irrigating Dialer .....	68	<b>NON-IRRIGATING CAPSULE POLISHERS.....</b>	<b>90</b>
Alpha-Chymotrypsin Cannula.....	68	Accutome Capsule Polishing Sweeper and Curette .....	90
Olive Tip Capsule Polisher .....	69	Gills-Welsh Capsule Polishing Curette.....	90
Chamber Maintainer .....	69	Holladay Posterior Capsule Polisher and Curette.....	90
Chamber Maintainer with Serrated Tip .....	70	Nightingale Posterior Capsule Polishing Curette .....	90
Infusion Cannula .....	70	Shepherd Capsule Polishing Curette.....	90
Membrane Micropick [Eaton].....	70	Singer Sweep Polisher .....	91
Retinal Backflush Cannula .....	70	Whitman Sheperd Capsule Polisher .....	91
Extrusion Cannula.....	71	Accutome 360-Degree Capsule Polishing Curette.....	91
Extrusion Cannula with Silicone Tubing .....	72	<b>CHALAZION INSTRUMENTS</b>	
High Viscosity Fluid Cannula [Peyman] .....	72	<b>CURETTES .....</b>	<b>94</b>
Membrane Dissector [Kingham] .....	72	Heath Chalazion Ring Curette.....	94
Subretinal Injector [Lambert].....	72	Meyerhoeffer Chalazion Curette .....	94
Subretinal Aspirator [Landers].....	72		
Vitreoretinal Micropick [Glaser] .....	73		
Vitreoretinal Cannula [Vander].....	73		
Subretinal Injector [Glaser].....	73		
MVR Cannula [Glaser].....	73		
Subretinal Cannula [Lambert].....	74		
LASIK Cannula [Dishler] .....	74		

**LENS MANIPULATORS & CHOPPERS****LENS MANIPULATORS ..... 96**

Anis Ball Tip Nucleus Manipulator .....	96
Barrett Duo Nucleus Rotator/Manipulator/Splitter .....	96
Bechert Lens Pusher .....	96
Bechert Nucleus Rotator .....	96
Clayman Nucleus Rotator .....	96
Drysdale Nucleus Manipulator .....	97
Fenzel Lens Manipulating Hook .....	97
Grayson Nucleus Manipulator .....	97
Grayson/Kuglen Double-Ended Manipulator .....	97
Hunkeler IOL Manipulator .....	98
Jaffe-Bechert Nucleus Rotator .....	98
Koch Phacoemulsification Manipulator .....	98
Koch Stop and Chop Manipulator .....	98
Lester IOL Manipulator .....	98
Lewicky Lens Manipulator Hook .....	99
Lieberman Microfinger Nucleus Manipulator .....	99
Lindstrom STAR Manipulator .....	100
Mackool Double-Ended Chopper and Spatula .....	100
Maloney No Hole IOL Manipulator .....	100
Maloney Nucleus Rotator .....	100
Maltsman-Fenzel Lens Manipulating Hook .....	100
Hunkeler IOL Manipulator .....	101
Masket Phaco Spatula .....	101
Nordan Capsule Elevator .....	101
O’Gawa Lens Dialer .....	101
Osher “Y” IOL Hook .....	102
Osher Iris Retractor .....	102
Osher Nucleus Manipulator .....	102
Pisacano Nucleus Rotator .....	102
Rentsch Boat Hook Lens Manipulator .....	103
Siepser Endocapsular Controller .....	103
Sinsky C-Hook, Modified .....	103
Sinsky Lens Manipulating Hook .....	103
Tennant Nucleus Manipulator .....	104

**CHOPPERS ..... 105**

Accutome Wand .....	105
Akahoshi Nucleus Sustainer .....	105
Ambidextrous Seibel Nucleus Chopper .....	106
Castroviejo Dissector .....	106
Chang Microfinger Phaco Chopper and Quick Chopper .....	106
Chang-Seibel Microfinger Chopper and Vertical Safety Chopper .....	106
Davidoff Ambidextrous Nucleus Chopper .....	106
Dodick-Kammann Nucleus Chopper .....	107
Escaf Nucleus Sustainer .....	107
Fukasaku Snapper Chopper .....	107
Goldberg Sideport Splitter .....	107
Haefliger Phaco Cleaver .....	107
He Hook Chopper .....	108
Keener Lens/Nucleus Divider .....	108
Koch Spatula and Nagahara Chopper .....	108
Lieberman Microfinger and Spatula .....	108

Mackool Phaco Chopper .....	108
Mackool Phaco Chopper and Nucleus Chopper .....	109
Maloney Quick-Chop .....	109
Nagahara Fine Chopper and Nichamin Quick Chopper .....	109
Nagahara Phaco Chopper .....	109
Nichamin Double-Ended Nucleus Chopper and Spatula .....	110
Nichamin Quick Chopper .....	110
Nichamin Quick Chopper II .....	110
Nichamin Triple Chopper .....	110
Nucleus Chopper and Safety Quick Chopper .....	110
Rosen Chopper .....	111
Seibel Nucleus Chopper .....	111
Seibel Nucleus Chopper and Safety Quick Chopper .....	111
Seibel Safety Quick Chopper .....	111
Steinert II Nucleus Claw Chopper .....	112
Sweeney Manipulator Cracker .....	112
Verges Phaco Chopper .....	112

**HOOKS & RETRACTORS****HOOKS ..... 114**

Bonn Iris Hook .....	114
Clayman Micro Iris Hook .....	114
Clayman-Jaffe Lens Manipulating Hook .....	114
Crawford Retrieving Hook .....	114
Crawford/Benger Probe Retrieving Hook .....	114
Culler Rectus Muscle Hook .....	115
Double Fixation Hook .....	115
Fukasaku Snapper Hook .....	115
Gass Retinal Detachment Hook .....	115
Graether Collar Button-Handle .....	115
Hirschman Iris Hook .....	116
Iris Hook .....	116
Jaffe Iris Hook .....	116
Jaffe Lens Manipulating Hook .....	116
Jaffe-Maltzman Lens Manipulating Hook .....	117
Kirby Expressor Double-Ended Hook and Loop .....	117
Kuglen Iris Hook Lens Manipulator .....	117
Maumenee Iris Hook .....	118
Shepard Iris Hook .....	118
Sinsky Iris and IOL Hook .....	119
Smith Expressor Hook .....	119
Stevens Tenotomy Hook .....	119
Twist Fixation Hook .....	119
Tyrell Iris Hook .....	120
University of Kansas Spatula and Hook .....	120
Green Strabismus Hook .....	120
Jameson Muscle Hook .....	120
Von Graefe Strabismus Hook .....	120

**RETRACTORS ..... 121**

Berke-Jaeger Lid Plate .....	121
Conway Lid Retractor .....	121
Desmarres Lid Retractor .....	121
Knapp Lacrimal Sac Retractor .....	122

Pupil Iris Retractor.....	122
Rizzuti Expressor and Iris Retractor.....	122
Schepens Orbital Retractor.....	122

## DSEK INSTRUMENTS

<b>DSEK .....</b>	<b>124</b>
Carlson DSEK Smoother.....	124
Descemet's DSEK/DSAEK Stripper.....	124
Rosenwasser Endothelial Stripper.....	124

## FIXATION RINGS & PICKS

<b>FIXATION RINGS.....</b>	<b>126</b>
Fine-Thornton Fixation Ring.....	126
Flieringa Scleral Fixation Ring .....	126
Globe Fixation Ring.....	127
Thornton Fixation Ring .....	127
<b>FIXATION PICKS .....</b>	<b>127</b>
Anis Scleral Twist Fixation Cone .....	127
Burch Fixation Pick.....	128

## FORCEPS & CLAMPS

<b>CAPSULE FORCEPS.....</b>	<b>130</b>
Arruga Capsule Forceps .....	130
Castroviejo Capsule Forceps.....	130
Gaskin Fragment Forceps .....	130
Kraff Capsule Tag Forceps.....	130
<b>CAPSULORHEXIS FORCEPS .....</b>	<b>131</b>
Devgan MICS Capsulorhexis Forceps.....	131
Gianetti MICS Capsulorhexis Forceps .....	131
Gimbel Capsulorhexis Forceps .....	131
Kellan Capsulorhexis Forceps.....	131
Lehner-Utrata Capsulorhexis Forceps .....	131
Masket Capsulorhexis Forceps.....	132
Nevyas Capsulorhexis Forceps.....	132
O'Gawa-Utrata Capsulorhexis Forceps .....	132
Utrata Capsulorhexis Forceps.....	132
Utrata MICS Capsulorhexis Forceps.....	134
<b>CHALAZION FORCEPS .....</b>	<b>134</b>
Baird Chalazion Forceps.....	134
Desmarres Chalazion Forceps .....	134
Francis Chalazion Forceps .....	134
Heath Chalazion Forceps.....	135
Hunt Chalazion Forceps .....	135
Lambert Chalazion Forceps .....	135
Wies Chalazion Forceps.....	135
<b>CILIA FORCEPS .....</b>	<b>136</b>
Barraquer Cilia Forceps .....	136
Cilia Forceps.....	136
Drews Cilia Forceps.....	136

Gradle Cilia Forceps.....	136
Swiss Cilia and Suture Forceps.....	137
<b>CORNEAL FORCEPS .....</b>	<b>137</b>
Castroviejo Colibri Corneal Forceps.....	137
Girard Corneoscleral Forceps.....	137
Hyde Corneal Forceps.....	138
Katzin-Barraquer Colibri Corneal Utility Forceps.....	138
Pierse Colibri Corneal Forceps .....	138
Polack Colibri Corneal Forceps .....	138
Thorpe Corneal Forceps.....	138
Troutman-Barraquer Colibri Corneal Forceps .....	139
<b>DSEK FORCEPS .....</b>	<b>139</b>
Charlie II Donor Forceps .....	139
Rossenwasser Donor Lamella Forceps.....	139
Snyder Stripping Forceps.....	140
<b>DRESSING FORCEPS.....</b>	<b>140</b>
Bishop-Harmon Dressing Forceps.....	140
Dressing Forceps .....	140
<b>FEMTOSECOND FORCEPS .....</b>	<b>141</b>
Femto LRI Enhancement Forceps .....	141
<b>FIXATION FORCEPS .....</b>	<b>141</b>
Castroviejo Fixation Forceps.....	141
Fechtner Conjunctiva Forceps .....	141
Graefe Fixation Forceps.....	142
Green Fixation Forceps .....	142
Kremer Corneal Fixation Forceps.....	142
Lester Fixation Forceps .....	142
McGregor Conjunctiva Forceps .....	142
Moody Fixation Forceps.....	143
Osher Fixation Forceps.....	143
Thorpe Conjunctiva Forceps.....	143
<b>HEMOSTATIC FORCEPS .....</b>	<b>143</b>
Hemostatic Forceps.....	143
Kelly Hemostatic Forceps.....	144
Sponge Forceps .....	144
<b>IOL FORCEPS .....</b>	<b>145</b>
Accutome Folding Forceps .....	145
Faulkner Lens Holding Forceps.....	145
Haberle-McPherson Lens Holding Forceps.....	145
Implant Removal Forceps.....	145
IOL Lens Loading Forceps .....	145
Accutome IOL Lens Loading Forceps .....	146
Livernois IOL Folding Forceps .....	146
Livernois IOL Holding Forceps.....	146
Steinert Folding Forceps .....	146
Universal II IOL Insertion Forceps.....	147
Universal III IOL Insertion Forceps.....	147
<b>JEWELER FORCEPS.....</b>	<b>147</b>
Jeweler Forceps .....	147
Suture Removal Forceps.....	148



Jewler's Type Utility and Splinter Forceps.....	148	<b>CLAMPS</b> .....	162
<b>LASIK FORCEPS</b> .....	149	Clamp.....	162
Buratto LASIK Flap Forceps.....	149	<b>I/A &amp; BIMANUAL HANDPIECES</b>	
<b>MUSCLE FORCEPS</b> .....	149	<b>DISPOSABLE I/A INSTRUMENTS</b> .....	164
Berke Ptosis Forceps.....	149	Bimanual I/A System.....	164
Putterman Muscle Forceps.....	149	Mono-Manual I/A System.....	164
Troutman Superior Rectus Forceps.....	149	<b>REUSABLE I/A INSTRUMENTS</b> .....	165
<b>PRE-CHOPPER FORCEPS</b> .....	150	Bimanual Aspirating Unit.....	165
Akahoshi PreChop Forceps.....	150	Bimanual Aspiration Cannula Tip.....	166
D&K Salvitti Akahoshi PreChopping Forceps.....	150	Bimanual Irrigating Unit.....	166
Dodick Nucleus Cracker.....	150	Bimanual Irrigation Cannula Tip.....	167
Ernest Nucleus Cracker.....	150	Donnenfeld Irrigating Hook.....	167
Salz Nucleus Splitter.....	151	I/A Handpiece.....	167
<b>RETINAL FORCEPS</b> .....	151	I/A Tip.....	168
Scleral Plug Forceps.....	151	<b>KNIFE HANDLES</b>	
<b>SUTURING FORCEPS</b> .....	151	<b>BARD-PARKER KNIFE HANDLES</b> .....	172
Bonn Suturing Forceps.....	151	Bard-Parker Knife Handle.....	172
Castroviejo Suturing Forceps.....	152	<b>BEAVER CHUCK KNIFE HANDLES</b> .....	172
Fine-Castroviejo Suturing Forceps.....	153	Beaver Chuck Knife Handle.....	172
Kelman-McPherson Suturing Forceps.....	153	<b>REUSABLE KNIVES</b>	
Manhattan Eye and Ear Suturing Forceps.....	154	<b>REUSABLE KNIVES</b> .....	174
O'Gawa Suture Fixation Forceps.....	154	Gill Corneal Knife.....	174
Paufique Suturing Forceps.....	154	Martinez Double-Ended Corneal Dissector Knife.....	174
Stern-Castroviejo Suturing Forceps.....	154	Tooke Corneal Knife.....	174
<b>TISSUE FORCEPS</b> .....	155	<b>LACRIMAL INSTRUMENTS</b>	
Adson Tissue Forceps.....	155	<b>LACRIMAL PROBES</b> .....	176
Bishop-Harmon Tissue Forceps.....	155	Bowman Lacrimal Probe Set.....	176
Hoskins Tissue Forceps.....	155	Bowman Lacrimal Probe.....	176
Tissue Forceps.....	156	Catalano Intubation Probe Set.....	177
<b>TYING FORCEPS</b> .....	156	Pigtail Probe.....	177
Bechert-McPherson Angled Tying Forceps.....	156	Jackson Lacrimal Intubation Set.....	177
Castroviejo Tying Forceps.....	156	<b>LACRIMAL DILATORS</b> .....	177
Fine Tying Forceps.....	156	Castroviejo Double-Ended Lacrimal Dilator.....	177
Gerl Tying Forceps.....	157	Hosford Double-Ended Lacrimal Dilator.....	178
Girard Fine Tying Forceps.....	157	Infant Lacrimal Dilator.....	178
Harms-Tuebingen Tying Forceps.....	157	Muldoon Lacrimal Dilator.....	178
Jaffe Tying Forceps.....	157	Ruedemann Lacrimal Dilator.....	178
Kelman-McPherson Tying Forceps.....	158	Wilder Lacrimal Dilator.....	178
McPherson Tying Forceps.....	158	<b>LASEK INSTRUMENTS</b>	
O'Gawa Tying Forceps.....	159	<b>LASEK INSTRUMENTS</b> .....	180
O'Gawa-Castroviejo Tying Forceps.....	159	Camellin LASEK Trephine.....	180
Sheets-McPherson Tying Forceps.....	160	LASEK Alcohol Well.....	180
Tennant Tying Forceps.....	160		
<b>UTILITY FORCEPS</b> .....	161		
Alabama University Utility Forceps.....	161		
Bonaccolto Utility Forceps.....	161		
Gill Iris Forceps.....	161		
Kennerdell Bayonet Forceps.....	161		
Nugent Utility Forceps.....	161		
Wills Hospital Utility Forceps.....	162		

LASEK Epithelial Trephine .....	180	Schocket Double-Ended Scleral Depressor .....	199
<b>LENS LOOPS</b>		<b>PUNCHES</b>	
<b>LENS LOOPS .....</b>	<b>182</b>	<b>PUNCHES .....</b>	<b>202</b>
Gills-Welsh Lens Loop .....	182	Kelly Descemet's Membrane Punch.....	202
Kansas Lens Loop.....	182	<b>RETINAL PICKS</b>	
Keener-Alt Lens Loop .....	182	<b>RETINAL PICKS .....</b>	<b>204</b>
Kirby Intra-Capsular Lens Loop .....	182	Olk Angled Retinal Pick .....	204
Lewis Lens Loop.....	183	<b>SCISSORS</b>	
New Orleans Eye and Ear Lens Loop.....	183	<b>CORNEAL SCISSORS .....</b>	<b>206</b>
Simcoe Double-Ended Nucleus Loop .....	183	Aebli Corneal Scissors.....	206
Wilder Lens Loop.....	183	Aebli Corneal Section Scissors .....	206
<b>NEEDLE HOLDERS</b>		Manson-Aebli Corneal Scissors .....	207
<b>LOCKING NEEDLE HOLDERS.....</b>	<b>186</b>	Azar Corneal Scissors.....	207
Anis Needle Holder, Locking.....	186	Barraquer Corneal Section Scissors.....	207
Barraquer Needle Holder, Locking .....	186	Castroviejo Corneal Scissors .....	207
Castroviejo Needle Holder, Locking .....	187	Castroviejo Corneal Section Scissors .....	208
Jaffe Needle Holder .....	188	Castroviejo Keratoplasty Scissors.....	209
Kalt Needle Holder .....	188	Hoffer-Stern Scissors.....	209
McPherson Needle Holder .....	189	Katzin Corneal Transplant Scissors.....	210
Needle Holder, Locking .....	189	Troutman-Castroviejo Corneal Section Scissors.....	210
Troutman Needle Holder .....	189	Troutman-Katzin Corneal Transplant Scissors .....	210
<b>NON-LOCKING NEEDLE HOLDERS .....</b>	<b>190</b>	<b>ENUCLEATION SCISSORS.....</b>	<b>210</b>
Anis Needle Holder, Non-Locking .....	190	Enucleation Scissors .....	210
Barraquer Needle Holder, Non-Locking .....	190	<b>EYE SCISSORS.....</b>	<b>211</b>
Castroviejo Needle Holder, Non-Locking.....	191	Eye Scissors .....	211
Cohan Needle Holder .....	191	<b>INTRAOCULAR SCISSORS .....</b>	<b>212</b>
McPherson Needle Holder .....	192	Intraocular Scissors.....	212
Needle Holder, Non-Locking.....	192	<b>IOL REMOVAL SCISSORS .....</b>	<b>213</b>
O'Gawa Needle Holder .....	192	Accutome IOL Cutter.....	213
Osher Needle Holder.....	193	<b>IRIS SCISSORS .....</b>	<b>213</b>
Troutman Needle Holder .....	193	Barraquer Iris Scissors .....	213
<b>OFFICE INSTRUMENTS</b>		Cohan-Vannas Curved Iris Scissors .....	213
<b>OPHTHALMIC BURRS .....</b>	<b>196</b>	DeWecker Iris Scissors .....	214
Aaron Burr 2.....	196	Iris Scissors.....	214
Aaron Burr 2 Accessories .....	196	McPherson-Vannas Iris Scissors.....	215
Algerbrush II.....	196	<b>MISCELLANEOUS SCISSORS.....</b>	<b>216</b>
Algerbrush II Accessories .....	196	Mayo Dissecting Scissors .....	216
<b>FOREIGN BODY INSTRUMENTS .....</b>	<b>197</b>	Troutman Conjunctival Scissors .....	216
Ellis Foreign Body Spud.....	197	Westcott Conjunctival Scissors .....	216
Foreign Body Curette .....	198	<b>STITCH SCISSORS .....</b>	<b>216</b>
Foreign Body Spud.....	198	Castroviejo Mini Keratoplasty-Utility-Stitch Scissors .....	216
Francis Spud .....	198	Fine Stitch Scissors.....	217
Golf Club Spud.....	198	Jaffe Stitch Scissors .....	217
<b>SCLERAL DEPRESSORS .....</b>	<b>199</b>	McPherson-Westcott Stitch Scissors .....	217
Flynn Scleral Depressor.....	199		
Schepens Scleral Depressor .....	199		

Stitch Scissors.....	217	<b>PHACO SPATULAS.....</b>	<b>234</b>
Westcott Type Stitch Scissors .....	218	Gimbel Nucleus Spatula .....	234
<b>STRABISMUS SCISSORS .....</b>	<b>218</b>	Jaffe Lens Spatula.....	234
Knapp Strabismus Scissors.....	218	Johnson Spatula.....	234
Strabismus Scissors .....	219	Knolle Lens Nucleus Spatula and Anterior Chamber Gauge.....	234
<b>SUTURE SCISSORS .....</b>	<b>219</b>	Knolle Nucleus Spatula .....	235
Littler Suture/Dissecting Scissors.....	219	Koch Nucleus Spatula .....	235
Stitch Removal Scissors .....	220	Koch Phacoemulsification Spatula.....	235
<b>TENOTOMY SCISSORS .....</b>	<b>220</b>	Lieppman Nucleus Spatula .....	235
McPherson-Westcott Tenotomy Scissors .....	220	Rowen Phaco Spatula .....	235
Shepard-Westcott Tenotomy Scissors .....	220	<b>REFRACTIVE SPATULAS .....</b>	<b>236</b>
Stevens Tenotomy Scissors .....	221	Kimura Platinum Spatula.....	236
Westcott Tenotomy Scissors.....	223	Maloney PRK Spatula.....	236
<b>UTILITY SCISSORS.....</b>	<b>223</b>	Paton Spatula and Spoon.....	236
Lister Bandage Scissors .....	223	<b>RETINAL SPATULAS .....</b>	<b>236</b>
Operating Scissors .....	224	Maumenee-Barraquer Vitreous Sweep Spatula.....	236
Utility Scissors.....	224	<b>SPECULUMS</b>	
Westcott Type Utility Scissors .....	225	<b>ADJUSTABLE SPECULUMS.....</b>	<b>238</b>
<b>VANNAS SCISSORS.....</b>	<b>225</b>	Cook Eye Speculum .....	238
Gills-Vannas Capsulotomy Scissors .....	225	Kammann Eye Speculum.....	238
Gills-Welsh-Vannas Micro Scissors.....	226	Lancaster Eye Speculum.....	238
Stern-Gills Scissors.....	226	Lester-Burch Eye Speculum .....	238
Uribe-Stern Scissors .....	226	Lieberman Adjustable Speculum.....	239
Uthoff-Gills Capsulotomy Scissors .....	226	Schott Eye Speculum.....	240
Vannas Capsulotomy Scissors .....	227	Williams Eye Speculum.....	240
Vannas Scissors .....	227	<b>ASPIRATING SPECULUMS .....</b>	<b>241</b>
<b>SPATULAS</b>		Lieberman Aspirating Speculum .....	241
<b>CYCLODIALYSIS SPATULAS.....</b>	<b>230</b>	Machat LASIK Speculum .....	241
Barraquer Cyclodialysis Spatula.....	230	<b>WIRE SPECULUMS.....</b>	<b>241</b>
Castroviejo Cyclodialysis Spatula.....	230	Varley LASIK/Femtosecond Lid Speculum.....	241
Castroviejo Synechia Spatula .....	230	Alfonso Eye Speculum .....	242
Wheeler/Elschnig Cyclodialysis Spatula.....	231	Barraquer Lid Speculum.....	242
<b>DSEK SPATULAS .....</b>	<b>231</b>	Floyd-Barraquer Eye Speculum .....	246
Cindy Sweeper DSEK Spatula.....	231	Kratz-Barraquer Eye Speculum.....	246
<b>FEMTOSECOND SPATULAS.....</b>	<b>231</b>	Kratz-Nichamin Lid Speculum .....	246
Eippert Femtosecond Spatula.....	231	Lehner Lid Speculum .....	247
Lane Femtosecond Incisional Spatula .....	232	Sauer Eye Speculum .....	247
Lee Femtosecond Spatula.....	232	Slade Refractive Speculum .....	247
Slade Femtosecond Laser Spatula .....	232	Temporal Approach Wire Speculum .....	248
Suarez Spreader.....	232	<b>SPOONS</b>	
<b>IRIS SPATULAS.....</b>	<b>233</b>	<b>EVISCERATION &amp; ENUCLEATION SPOONS.....</b>	<b>250</b>
Barraquer Iris Spatula.....	233	Bunge Evisceration Spoon .....	250
Culler Iris Spatula .....	233	Wells Enucleation Spoon .....	250
Iris Spatula .....	233	<b>LENS SPOONS .....</b>	<b>250</b>
<b>LASIK SPATULAS .....</b>	<b>233</b>	Culler Lens Spoon.....	250
Intralase Flap Lifter and Retreatment Spatula .....	233		
Katzen LASIK Flap “Unzipper” .....	234		



**STERILIZATION TRAYS**

<b>METAL TRAYS</b> .....	<b>252</b>
Metal Microsurgical Instrument Sterilization Tray .....	252
<b>PLASTIC TRAYS</b> .....	<b>253</b>
Diamond Knife Tray .....	253
Plastic Microsurgical Instrument Sterilization Tray .....	253
Plastic Phaco Instrument Sterilization Tray .....	254
Sterilization Tray Replacement Mat .....	254

**TREPHINES & PUNCHES**

<b>DISPOSABLE TREPHINES &amp; PUNCHES</b> .....	<b>256</b>
Disposable Radial Vacuum Trepine .....	256
Vacuum Donor Punch .....	256
<b>REUSABLE TREPHINES &amp; PUNCHES</b> .....	<b>257</b>
Long Reusable Trepine Blade .....	257
Universal Trepine Blade Holder .....	259

**SUTURES**

<b>NYLON</b> .....	<b>262</b>
Sutures 11-0 Nylon .....	262
Sutures 10-0 Nylon .....	263
Sutures 9-0 Nylon .....	265
Sutures 8-0 Nylon .....	266
Sutures 7-0 Nylon .....	267
Sutures 6-0 Nylon .....	269
Sutures 5-0 Nylon .....	270
<b>POLYESTER</b> .....	<b>271</b>
Sutures 10-0 Polyester .....	271
Sutures 5-0 Polyester .....	272
Sutures 4-0 Polyester .....	273
<b>POLYGLYCOLIC ACID</b> .....	<b>274</b>
Sutures 10-0 Polyglycolic Acid .....	274
Sutures 9-0 Polyglycolic Acid .....	275
Sutures 8-0 Polyglycolic Acid .....	275
Sutures 7-0 Polyglycolic Acid .....	276
Sutures 6-0 Polyglycolic Acid .....	276
Sutures 5-0 Polyglycolic Acid .....	277
<b>POLYPROPYLENE</b> .....	<b>278</b>
Sutures 6-0 Polypropylene .....	278
<b>SILK</b> .....	<b>278</b>
Sutures 8-0 Silk .....	278
Sutures 7-0 Silk .....	279
Sutures 6-0 Silk .....	280
Sutures 5-0 Silk .....	281
Sutures 4-0 Silk .....	282

**SURGICAL DISPOSABLES**

<b>APPAREL</b> .....	<b>286</b>
Exam Gown .....	286
Isolation and Fluid-Resistant Surgical Gown .....	286
Non-Skid Shoe Cover .....	287
Smooth Bottom Shoe Cover .....	289
McKesson Bouffant Cap .....	289
Pro Series Bouffant Cap .....	289
Single-Ply Bouffant Cap .....	290
Surgeon Cap .....	291
Surgical Gown .....	292
<b>CAUTERIES</b> .....	<b>293</b>
Change-a-Tip Cautery .....	293
High-Temperature Cautery .....	294
Low-Temperature Cautery .....	294
Eye Bubble .....	295
<b>SCALPELS &amp; BLADES</b> .....	<b>295</b>
BD Bard-Parker Scalpel Blade .....	295
Beaver Mini-Blade .....	296
Change-a-Blade Safety Scalpel Handle .....	296
Cincinnati Lance Blade .....	296
Cincinnati Surgical Blade Remover .....	297
Cincinnati Surgical Blade .....	297
Miltex General-Purpose Blade .....	298
Miniature Surgical Blade .....	298
Size 10 Disposable Scalpel .....	299
Size 11 Disposable Scalpel .....	299
Size 11 Safety Disposable Scalpel .....	300
Size 15 Disposable Scalpel .....	300
Size 15 Safety Disposable Scalpel .....	301
Size 21 Disposable Scalpel .....	301
Surgistar Handle and Blade .....	302
<b>DRAPES</b> .....	<b>302</b>
Adhesive Towel Drape .....	302
Aperture Drape .....	303
Aperture Pouch Drape .....	304
Convertors Mayo Stand Cover .....	304
Convertors Refractive Drape .....	304
Drape Cover .....	305
General-Purpose Drape .....	305
Incise Drape .....	307
Incise Drape with Pouch .....	308
Instrument Cover .....	309
Medi-Pak Performance Drape .....	309
Poly U Drape .....	309
Split Sheet Drape .....	310
Towel Drape .....	310
<b>EYE SHIELDS</b> .....	<b>311</b>
Blue Eye Shield .....	311
Clear Eye Shield .....	311
Gray Eye Shield .....	313

Metal Eye Shield.....	313
<b>IRIS RETRACTORS.....</b>	<b>313</b>
Disposable Iris Retractor.....	313
Reusable Iris Retractor.....	314
<b>LIQUID BANDAGES.....</b>	<b>314</b>
Histoacryl Topical Skin Adhesive.....	314
<b>PVA PRODUCTS/WECK-CEL.....</b>	<b>315</b>
Corneal Light Shield.....	315
Cellulose Eye Spear.....	315
PVA Eye Spear.....	315
LASIK PVA Disk.....	316
Ultracell Instrument Wipe.....	316
<b>SURGICAL GLOVES.....</b>	<b>317</b>
Derma Prene Ultra Surgical Gloves.....	317
Encore Acclaim Surgical Gloves.....	317
Encore Surgical Gloves.....	318
No Powder Surgical Gloves.....	318
Perry Performance Plus Micro-Thin Surgical Gloves.....	318
Perry Performance Plus Surgical Gloves.....	319
Sempermed Supreme Surgical Gloves.....	323
SensiCare Surgical Gloves.....	323
Sensi-Touch Surgical Gloves.....	324
Original Perry Style 42 Surgical Gloves.....	324
Triflex Surgical Gloves.....	325
Triumph Green Surgical Gloves.....	325
Triumph LT Surgical Gloves.....	325
<b>SURGICAL LENSES.....</b>	<b>326</b>
Bi-Concave Disposable Lens.....	326
Flat Disposable Lens.....	326
Flat SSV Disposable Lens.....	326
Magnifying Disposable Lens.....	327
Wide Field Disposable Lens.....	327
30-Degree Prism Disposable Lens.....	327
30-Degree Prism SSV ACS Lens.....	328

## INSTRUMENT COVERS

<b>PROTECTORS &amp; GUARDS.....</b>	<b>330</b>
Comply Instrument Protector.....	330
Osteotome Instrument Tip Guard.....	330
Round Instrument Tip Guard.....	330
Standard Instrument Tip Guard.....	331

## CLEANING & STERILIZING

<b>DIAMOND KNIFE CLEANING SYSTEMS.....</b>	<b>334</b>
Opti-Kleen.....	334
<b>INDICATOR STRIPS.....</b>	<b>334</b>
Biological Indicator Incubator.....	334
Biological Indicator Test Pack.....	335
Biological Indicator Vial.....	335
Class 4 Steam Indicator Strip.....	337
Class 5 Steam Indicator Strip.....	338
Dry Heat Sterilization Indicator Strip.....	338
Indicator Label.....	338
OK Steam Sterilization Strip.....	339
Steam Indicator Tape.....	339
<b>STERILIZATION POUCHES.....</b>	<b>340</b>
Dry-Heat Sterilization Pouch.....	340
Steam Sterilization Pouch.....	340
<b>ULTRASONIC CLEANERS.....</b>	<b>343</b>
Crest 0.75-Gallon Ultrasonic Cleaner.....	343
Crest 2.5-Gallon Ultrasonic Cleaner.....	343
Crest 5-Gallon Ultrasonic Cleaner.....	343
<b>QUICKRINSE INSTRUMENT RINSE SYSTEM.....</b>	<b>344</b>
QuickRinse Cleaning System.....	344
<b>CRYO UNITS</b>	
<b>CRYO UNITS.....</b>	<b>346</b>
Keeler Cryomatic Cryo Unit.....	346

## PRODUCT NUMBER LOOKUP





# AccuSharp Disposable Ophthalmic Knives

NON-GUARDED DISPOSABLE OPHTHALMIC KNIVES

Item #	Description	Image
<b>AccuSharp Ophthalmic Angled Slit Knife</b>		
Disposable, single-use metal blades, ophthalmic angled slit knives with red handles. Comes with bevel up or double bevel options with a 45 degree angled tip. Packaged individually, sterile. Sold 6 per box.		
AB-ASLI0	<b>1.0mm Angled Slit Knife</b> 1.0mm wide tip, blade is bevel up.	
AB-ASLI2	<b>1.2mm Angled Slit Knife</b> 1.2mm wide tip, blade is bevel up.	
AB-ASLI8	<b>1.8mm Angled Slit Knife</b> 1.8mm wide tip, blade is bevel up.	
AB-ASLI8DB	<b>1.8mm Angled Slit Knife</b> 1.8mm wide tip, blade is double bevel.	
AB-ASL20	<b>2.0mm Angled Slit Knife</b> 2.0mm wide tip, blade is bevel up.	
AB-ASL22	<b>2.2mm Angled Slit Knife</b> 2.2mm wide tip, blade is bevel up.	
AB-ASL22DB	<b>2.2mm Angled Slit Knife</b> 2.2mm wide tip, blade is double bevel.	
AB-ASL23	<b>2.3mm Angled Slit Knife</b> 2.3mm wide tip, blade is bevel up.	
AB-ASL24	<b>2.4mm Angled Slit Knife</b> 2.4mm wide tip, blade is bevel up.	
AB-ASL24DB	<b>2.4mm Angled Slit Knife</b> 2.4mm wide tip, blade is double bevel.	
AB-ASL25	<b>2.5mm Angled Slit Knife</b> 2.5mm wide tip, blade is bevel up.	
AB-ASL25DB	<b>2.5mm Angled Slit Knife</b> 2.5mm wide tip, blade is double bevel.	
AB-ASL26	<b>2.65mm Angled Slit Knife</b> 2.65mm wide tip, blade is bevel up.	
AB-ASL26DB	<b>2.65mm Angled Slit Knife</b> 2.65mm wide tip, blade is double bevel.	
AB-ASL27	<b>2.75mm Angled Slit Knife</b> 2.75mm wide tip, blade is bevel up.	
AB-ASL27DB	<b>2.75mm Angled Slit Knife</b> 2.75mm wide tip, blade is double bevel.	
AB-ASL28	<b>2.8mm Angled Slit Knife</b> 2.8mm wide tip, blade is bevel up.	
AB-ASL28DB	<b>2.8mm Angled Slit Knife</b> 2.8mm wide tip, blade is double bevel.	
AB-ASL285	<b>2.85mm Angled Slit Knife</b> 2.85mm wide tip, blade is bevel up.	

## NON-GUARDED DISPOSABLE OPHTHALMIC KNIVES

Item #	Description	Image
AB-ASL30	<b>3.0mm Angled Slit Knife</b> 3.0mm wide tip, blade is bevel up.	
AB-ASL30DB	<b>3.0mm Angled Slit Knife</b> 3.0mm wide tip, blade is double bevel.	
AB-ASL32	<b>3.2mm Angled Slit Knife</b> 3.2mm wide tip, blade is bevel up.	
AB-ASL32DB	<b>3.2mm Angled Slit Knife</b> 3.2mm wide tip, blade is double bevel.	
AB-ASL35	<b>3.5mm Angled Slit Knife</b> 3.5mm wide tip, blade is bevel up.	

**AccuSharp Ophthalmic Straight Knife**

Disposable, single-use metal blades, ophthalmic straight knives with pink handles. Blades are available in various degrees but all blades are double bevel. Packaged individually, sterile. Sold 6 per box.

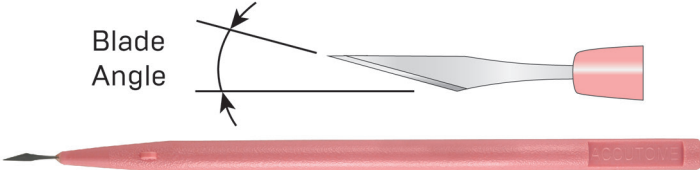
AB-AST15	<b>15-Degree Straight Knife</b> 15-degree angled blade.	
AB-AST22	<b>22.5-Degree Straight Knife</b> 22.5-degree angled blade.	
AB-AST30	<b>30-Degree Straight Knife</b> 30-degree angled blade.	
AB-AST45	<b>45-Degree Straight Knife</b> 45-degree angled blade.	

**AccuSharp Ophthalmic Sideport/MVR Knife**

Disposable, single-use metal blades, ophthalmic Sideport/MVR knives with green handles. Blades are available in various sizes and gauges with angled or straight shafts. Packaged individually, sterile. Sold 6 per box.

AB-AVR10	<b>1.0mm Angled Sideport</b> 1.0mm wide sideport blade with angled shaft.	
AB-AVR10S	<b>1.0mm Straight Sideport</b> 1.0mm wide sideport blade with straight shaft.	
AB-AVR12	<b>1.2mm Angled Sideport</b> 1.2mm wide sideport blade with angled shaft.	
AB-AVR19	<b>19 Gauge MVR Lance</b> 19 gauge MVR blade with straight shaft.	
AB-AVR19A	<b>19 Gauge MVR Lance</b> 19 gauge MVR blade with angled shaft.	
AB-AVR20	<b>20 Gauge MVR Lance</b> 20 gauge MVR blade with straight shaft.	
AB-AVR20A	<b>20 Gauge MVR Lance</b> 20 gauge MVR blade with angled shaft.	
AB-AVR23A	<b>23 Gauge MVR Lance</b> 23 gauge MVR blade with angled shaft.	
AB-AVR25	<b>25 Gauge MVR Lance</b> 25 gauge MVR blade with straight shaft.	

NON-GUARDED DISPOSABLE OPHTHALMIC KNIVES

Item #	Description	Image
--------	-------------	-------

**AccuSharp Ophthalmic Crescent Knife**

Disposable, single-use metal blades, ophthalmic crescent knives with yellow handles. Crescent blades are rounded and measure 2.0mm in width. Blades are available with the bevel up or down and straight or angled. Packaged individually, sterile. Sold 6 per box.

AB-ACD26 **Angled Crescent Knife**  
Blade is bevel down with 45-degree angled tip.

AB-ACS20 **Straight Crescent Knife**  
Blade is bevel up with straight tip.

AB-ACU26 **Angled Crescent Knife**  
Blade is bevel up with 45-degree angled tip.

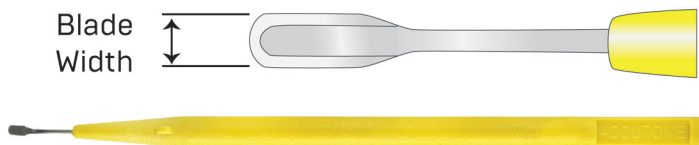

**AccuSharp Ophthalmic Angled Implant Knife**

Disposable, single-use metal blades, ophthalmic angled implant knives with blue handles. Blades are available in various widths and are bevel up with 45-degree angled tips. Packaged individually, sterile. Comes in a box of 6.

AB-ARS32 **3.2mm R Slit Knife**  
3.2mm width blade.

AB-ARS35 **3.5mm R Slit Knife**  
3.5mm width blade.

AB-ARS41 **4.1mm R Slit Knife**  
4.1mm width blade.

AB-ARS52 **5.2mm R Slit Knife**  
5.2mm width blade.

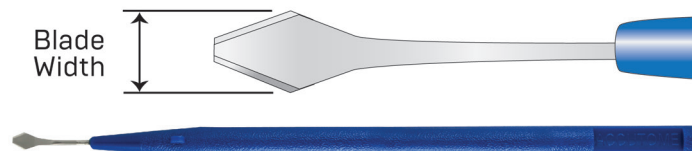

**Stab Knife**

Beaver-Visitec and Sharpoint brand disposable stab knife tips that screw into handles, handles not included. Blue in color with 15-degree angled tips. Sold 6 per box.

AXI4112 **Beaver-Visitec Micro-Sharp Blade**  
Disposable 3.0mm restricted blade depth.



AX721502 **Sharpoint Stab Knife**  
Sharpoint stab knives are heat-tempered to provide a strong, true point for easy penetration during initial stab incisions. Straight blade.

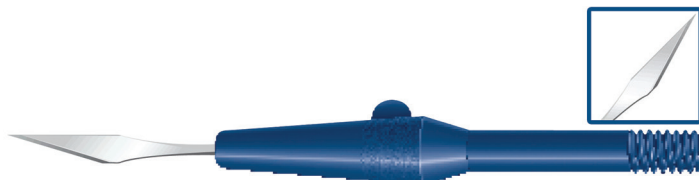

AX721532 **Sharpoint Stab Knife**  
Sharpoint stab knives are heat-tempered to provide a strong, true point for easy penetration during initial stab incisions. 3.0mm straight restricted blade depth.

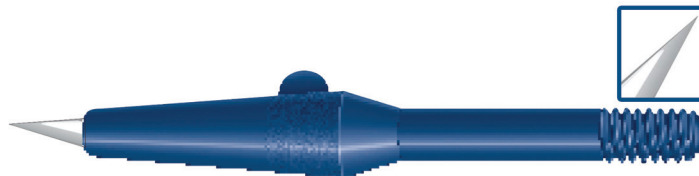



**GUARDED DISPOSABLE OPHTHALMIC KNIVES**

Item #	Description	Image
<b>AccuSharp Guarded Ophthalmic Angled Slit Knife</b>		
Disposable, single-use metal blades, ophthalmic angled slit knives with blue handles. Handle has smooth, single handed blade retraction and has ergonomic design. Blades have superior sharpness and are available in various widths and bevel designs with 45-degree angled tips. Packaged individually, sterile. Sold 6 per box.		
AB-ASL22G	<b>2.2mm Guarded Angled Slit Knife</b> 2.2mm blade width, bevel up.	
AB-ASL24G	<b>2.4mm Guarded Angled Slit Knife</b> 2.4mm blade width, bevel up.	
AB-ASL24DBG	<b>2.4mm Guarded Angled Slit Knife</b> 2.4mm blade width, double bevel.	
AB-ASL25G	<b>2.5mm Guarded Angled Slit Knife</b> 2.5mm blade width, bevel up.	
AB-ASL26G	<b>2.65mm Guarded Angled Slit Knife</b> 2.65mm blade width, bevel up.	
AB-ASL27G	<b>2.75mm Guarded Angled Slit Knife</b> 2.75mm blade width, bevel up.	
AB-ASL28G	<b>2.8mm Guarded Angled Slit Knife</b> 2.8mm blade width, bevel up.	
AB-ASL30G	<b>3.0mm Guarded Angled Slit Knife</b> 3.0mm blade width, bevel up.	
AB-ASL32G	<b>3.2mm Guarded Angled Slit Knife</b> 3.2mm blade width, bevel up.	

<b>AccuSharp Guarded Ophthalmic Straight Knife</b>		
Disposable, single-use metal blades, ophthalmic straight knives with blue handles. Handle has smooth, single handed blade retraction and has ergonomic design. Blades have superior sharpness and are available in various angles and are double bevel. Packaged individually, sterile. Sold 6 per box.		
AB-AST15G	<b>15-Degree Guarded Straight Knife</b> 15-degree angled blade, double bevel.	
AB-AST22G	<b>22.5-Degree Guarded Straight Knife</b> 22.5-degree angled blade, double bevel.	

<b>AccuSharp Guarded Ophthalmic Sideport/MVR Knife</b>		
Disposable, single-use metal blades, ophthalmic Sideport and MVR knives with blue handles. Handle has smooth, single handed blade retraction and has ergonomic design. Blades have superior sharpness and are available in various sizes and are straight or angled. Packaged individually, sterile. Sold 6 per box.		
AB-AVR10AG	<b>1.0mm Guarded Angled Sideport</b> 1.0mm wide sideport blade with angled shaft.	
AB-AVR19G	<b>19 Gauge Guarded MVR Lance</b> 19 gauge MVR blade with straight shaft.	
AB-AVR19AG	<b>19 Gauge Guarded MVR Lance</b> 19 gauge MVR blade with angled shaft.	
AB-AVR20G	<b>20 Gauge Guarded MVR Lance</b> 20 gauge MVR blade with straight shaft.	

**GUARDED DISPOSABLE OPHTHALMIC KNIVES**

Item #	Description	Image
AB-AVR20AG	<b>20 Gauge Guarded MVR Lance</b> 20 gauge MVR blade with angled shaft.	
AB-AVR21G	<b>21 Gauge Guarded MVR Lance</b> 21 gauge MVR blade with straight shaft.	
AB-AVR21AG	<b>21 Gauge Guarded MVR Lance</b> 21 gauge MVR blade with angled shaft.	
AB-AVR23G	<b>23 Gauge Guarded MVR Lance</b> 23 gauge MVR blade with straight shaft.	
AB-AVR23AG	<b>23 Gauge Guarded MVR Lance</b> 23 gauge MVR blade with angled shaft.	
AB-AVR25G	<b>25 Gauge Guarded MVR Lance</b> 25 gauge MVR blade with straight shaft.	
AB-AVR25AG	<b>25 Gauge Guarded MVR Lance</b> 25 gauge MVR blade with angled shaft.	

**AccuSharp Guarded Ophthalmic Crescent Knife**

Disposable single-use metal blades, crescent knife, 2.0mm, bevel up, 45-degree angled tip. Blue handle with smooth, single handed blade retraction. Packaged individually, sterile. Sold 6 per box.

AB-ACU26G	<b>2.0mm Guarded Crescent Knife</b>	
-----------	-------------------------------------	--

**AccuSharp Guarded Ophthalmic LRI Knife**

Disposable, single-use metal blades, ophthalmic LRI knives with blue handles. Handle has smooth, single handed blade retraction and has ergonomic design. Blades have superior sharpness and are available in various preset incision depths with a 1.0mm blade width. Packaged individually, sterile. Sold 6 per box.

AB-ALRI500G	<b>500 Micron Guarded LRI Knife</b> 500 micron preset incision depth.	
AB-ALRI550G	<b>550 Micron Guarded LRI Knife</b> 550 micron preset incision depth.	
AB-ALRI600G	<b>600 Micron Guarded LRI Knife</b> 600 micron preset incision depth.	

# Diamond Knives



# On the Cutting Edge

Accutome's diamond knives are the perfect blend of design and craftsmanship, in order to make superior corneal incisions. With an in-house repair facility, Accutome is able to provide high-quality repairs and quick repair turnaround times. By owning it's own diamond-cutting facility, Accutome is able to offer a diamond knife exchange program, allowing you to upgrade or change blade designs as your incision needs change.

## Features

- Unsurpassed sharpness
- Titanium and aluminum handles
- Lifetime warranty on titanium handles
- More cost effective than metal blades
- Variety of sizes and configurations available to fit your surgical needs

Please contact your Accutome sales representative at (800) 979.2020 or visit us on the web at [www.accutome.com](http://www.accutome.com) for additional information on our complete diamond knife product line.



PHACO INCISION DIAMOND KNIVES

Item #	Description	Image
<b>Simplicity Series</b>		
The Simplicity Series is the perfect blend of design and craftsmanship, helping make superior corneal incisions. The blade features a unique top and bottom bevel design, which creates a self-sealing incision without having to applanate or "dimple down". Various blade sizes available with four sharp sides. Handle is 100% titanium with J-locking mechanism and angled blade holder.		
AK6419	<b>2.2mm Clear Cornea Blade</b> 2.2mm blade width.	
AK6424	<b>2.4mm Clear Cornea Blade</b> 2.4mm blade width.	
AK6415	<b>2.5mm Clear Cornea Blade</b> 2.5mm blade width.	
AK6410	<b>2.65mm Clear Cornea Blade</b> 2.65mm blade width.	
AK6427	<b>2.75mm Clear Cornea Blade</b> 2.75mm blade width.	
AK6411	<b>2.8mm Clear Cornea Blade</b> 2.8mm blade width.	
AK6412	<b>3.0mm Clear Cornea Blade</b> 3.0mm blade width.	
AK6413	<b>3.2mm Clear Cornea Blade</b> 3.2mm blade width.	

<b>Simplicity Trapezoid Series</b>		
The Simplicity Trapezoid Series is the perfect blend of design and craftsmanship, helping make superior corneal incisions. It features a blade with a unique top and bottom bevel design, which creates a self-sealing incision without having to applanate or "dimple down". Four sharp sided, trapezoid shaped blades with two different blade widths allowing for a small or large incision. Handle is 100% titanium with J-locking mechanism and angled blade holder.		
AK6449	<b>2.2mm/2.4mm Trapezoid Blade</b> 2.2mm width at front of blade (width 1) and 2.4mm width blade at back of blade (width 2).	
AK6450	<b>2.5mm/2.8mm Trapezoid Blade</b> 2.5mm width at front of blade (width 1) and 2.8mm width blade at back of blade (width 2).	
AK6459	<b>2.5mm/2.9mm Trapezoid Blade</b> 2.5mm width at front of blade (width 1) and 2.9mm width blade at back of blade (width 2).	
AK6461	<b>2.5mm/3.0mm Trapezoid Blade</b> 2.5mm width at front of blade (width 1) and 3.0mm width blade at back of blade (width 2).	
AK6465	<b>2.5mm/3.5mm Trapezoid Blade</b> 2.5mm width at front of blade (width 1) and 3.5mm width blade at back of blade (width 2).	
AK6451	<b>2.65mm/3.0mm Trapezoid Blade</b> 2.65mm width at front of blade (width 1) and 3.0mm width blade at back of blade (width 2).	



## PHACO INCISION DIAMOND KNIVES

Item #	Description	Image
AK6452	<b>2.7mm/3.2mm Trapezoid Blade</b> 2.7mm width at front of blade (width 1) and 3.2mm width blade at back of blade (width 2).	
AK6453	<b>2.8mm/3.0mm Trapezoid Blade</b> 2.8mm width at front of blade (width 1) and 3.0mm width blade at back of blade (width 2).	
AK6458	<b>2.8mm/3.2mm Trapezoid Blade</b> 2.8mm width at front of blade (width 1) and 3.2mm width blade at back of blade (width 2).	
AK6454	<b>3.0mm/3.2mm Trapezoid Blade</b> 3.0mm width at front of blade (width 1) and 3.2mm width blade at back of blade (width 2).	
AK6455	<b>3.0mm/3.5mm Trapezoid Blade</b> 3.0mm width at front of blade (width 1) and 3.5mm width blade at back of blade (width 2).	
AK6456	<b>3.2mm/3.5mm Trapezoid Blade</b> 3.2mm width at front of blade (width 1) and 3.5mm width blade at back of blade (width 2).	

**Dual Bevel Diamond Knife (Dual Sides Sharp)**

The Dual Bevel series provides a great combination of performance and affordability. Every Accutome blade is manufactured to the highest quality and specifications inside of our Accutome facility. Various blade sizes available with two sharp sides. Handle is 100% titanium with J-locking mechanism and angled blade holder.

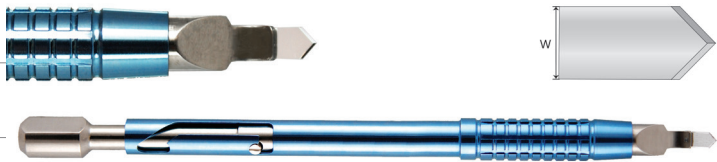
AK6007S	<b>1.65mm Dual Bevel Blade</b> 1.65mm blade width.	
AK6009S	<b>2.2mm Dual Bevel Blade</b> 2.2mm blade width.	
AK6023S	<b>2.4mm Dual Bevel Blade</b> 2.4mm blade width.	
AK6005-45	<b>2.5mm Dual Bevel Blade</b> 2.5mm blade width.	
AK6000-45	<b>2.65mm Dual Bevel Blade</b> 2.65mm blade width.	
AK6001-45	<b>2.8mm Dual Bevel Blade</b> 2.8mm blade width.	
AK6002-45	<b>3.0mm Dual Bevel Blade</b> 3.0mm blade width.	
AK6003-45	<b>3.2mm Dual Bevel Blade</b> 3.2mm blade width.	

PHACO INCISION DIAMOND KNIVES

Item #	Description	Image
<b>Dual Bevel Diamond Knife (Four Sides Sharp)</b>		
The Dual Bevel Series provides a great combination of performance and affordability. Every Accutome blade is manufactured to the highest quality and specifications inside of our Accutome facility. Various blade sizes available with four sharp sides. Handle is 100% titanium with J-locking mechanism and angled blade holder.		
AK6017S	<b>1.65mm Dual Bevel Blade</b> 1.65mm blade width.	
AK6021S	<b>1.8mm Dual Bevel Blade</b> 1.8mm blade width.	
AK6022S	<b>2.0mm Dual Bevel Blade</b> 2.0mm blade width.	
AK6019S	<b>2.2mm Dual Bevel Blade</b> 2.2mm blade width.	
AK6024S	<b>2.4mm Dual Bevel Blade</b> 2.4mm blade width.	
AK6015-45	<b>2.5mm Dual Bevel Blade</b> 2.5mm blade width.	
AK6010-45	<b>2.65mm Dual Bevel Blade</b> 2.65mm blade width.	
AK6011-45	<b>2.8mm Dual Bevel Blade</b> 2.8mm blade width.	
AK6012-45	<b>3.0mm Dual Bevel Blade</b> 3.0mm blade width.	
AK6013-45	<b>3.2mm Dual Bevel Blade</b> 3.2mm blade width.	

**Dual Bevel Trapezoid Diamond Knife**

The Dual Bevel series provides a great combination of performance and affordability. Every Accutome blade is manufactured to the highest quality and specifications inside of our Accutome facility. Four sharp sided, trapezoid shaped blades with two different blade widths allowing for a small or large incision. Handle is 100% titanium with J-locking mechanism and angled blade holder.

AK6047	<b>1.2mm/1.4mm Trapezoid Blade</b> 1.2mm width at front of blade (width 1) and 1.4mm width blade at back of blade (width 2).	
AK6072	<b>2.0mm/2.2mm Trapezoid Blade</b> 2.0mm width at front of blade (width 1) and 2.2mm width blade at back of blade (width 2).	
AK6070-60	<b>2.2mm/2.5mm Trapezoid Blade</b> 2.2mm width at front of blade (width 1) and 2.5mm width blade at back of blade (width 2).	
AK6050	<b>2.5mm/2.8mm Trapezoid Blade</b> 2.5mm width at front of blade (width 1) and 2.8mm width blade at back of blade (width 2).	

## PHACO INCISION DIAMOND KNIVES

Item #	Description	Image
AK6059	<b>2.5mm/2.9mm Trapezoid Blade</b> 2.5mm width at front of blade (width 1) and 2.9mm width blade at back of blade (width 2).	
AK6064	<b>2.5mm/3.0mm Trapezoid Blade</b> 2.5mm width at front of blade (width 1) and 3.0mm width blade at back of blade (width 2).	
AK6060	<b>2.5mm/3.2mm Trapezoid Blade</b> 2.5mm width at front of blade (width 1) and 3.2mm width blade at back of blade (width 2).	
AK6065	<b>2.5mm/3.5mm Trapezoid Blade</b> 2.5mm width at front of blade (width 1) and 3.5mm width blade at back of blade (width 2).	
AK6051	<b>2.65mm/3.0mm Trapezoid Blade</b> 2.65mm width at front of blade (width 1) and 3.0mm width blade at back of blade (width 2).	
AK6052	<b>2.7mm/3.2mm Trapezoid Blade</b> 2.7mm width at front of blade (width 1) and 3.2mm width blade at back of blade (width 2).	
AK6053	<b>2.8mm/3.0mm Trapezoid Blade</b> 2.8mm width at front of blade (width 1) and 3.0mm width blade at back of blade (width 2).	
AK6058	<b>2.8mm/3.2mm Trapezoid Blade</b> 2.8mm width at front of blade (width 1) and 3.2mm width blade at back of blade (width 2).	
AK6067	<b>2.8mm/3.5mm Trapezoid Blade</b> 2.8mm width at front of blade (width 1) and 3.5mm width blade at back of blade (width 2).	
AK6054	<b>3.0mm/3.2mm Trapezoid Blade</b> 3.0mm width at front of blade (width 1) and 3.2mm width blade at back of blade (width 2).	

## SPECIALTY DIAMOND KNIVES

Item #	Description	Image
<b>Crescent Diamond Knife</b>		
Accutome's Crescent blades are manufactured in-house, making it a high-quality product at an affordable price. Crescent blades have rounded blade tips that are available in various blade widths. Handle is 100% titanium with J-locking mechanism and angled blade holder.		
AK6044	<b>1.0mm Crescent Blade</b> 1.0mm blade width.	
AK6040	<b>1.4mm Crescent Blade</b> 1.4mm blade width.	
AK6041	<b>2.0mm Crescent Blade</b> 2.0mm blade width.	

SPECIALTY DIAMOND KNIVES

Item #	Description	Image
--------	-------------	-------

**Sclerostomy Diamond Knife**

Designed for implanting the Ex-Press filtration device. Blade measures 0.4mm in width and has two sharp sides. Handle is 100% titanium with J-locking mechanism and straight blade holder.

AK6180 **Sclerostomy Lancet**

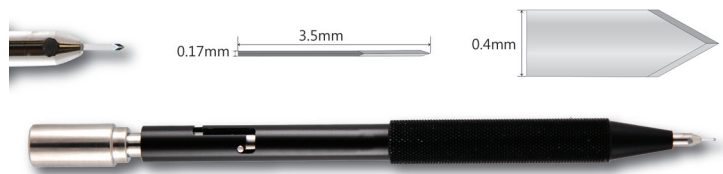

**Universal Cataract Diamond Knife**

Accutome's Universal Cataract diamond knives are manufactured in-house, making it a high-quality product at an affordable price. The Universal and Surgeon's Choice blades measure 1.0mm in width and have four sharp sides. Handle is 100% titanium with J-locking mechanism and straight blade holder.

AK6030 **1.0mm Universal Blade**  
No footplate, regular handle.

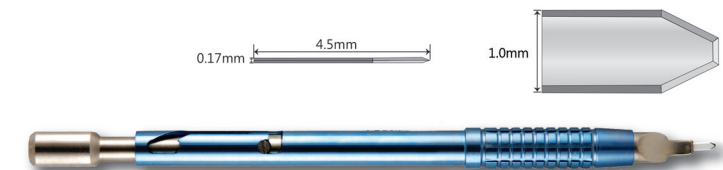

AK6230-2 **Dual Preset Surgeon's Choice Blade**  
Footplate blade with step handle that has 0.3, 0.6, and full extension increments for increased versatility.

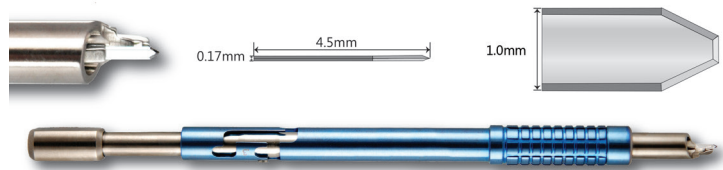

AK6230-3 **Triple Preset Surgeon's Choice Blade**  
Footplate blade with step handle that has 0.5, 0.55, 0.6, and full extension increments for increased versatility.

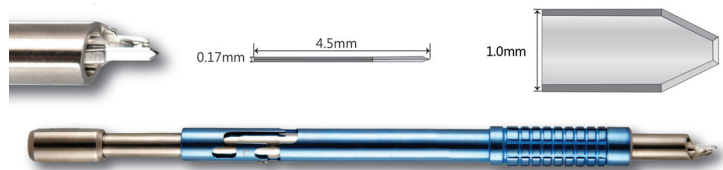

PARACENTESIS/STAB DIAMOND KNIVES

Item #	Description	Image
--------	-------------	-------

**Hawkeye Series**

Hawkeye Series knives are the most used knives in all of ophthalmic surgery. The Hawkeye Series provides great value and sharpness for paracentesis incisions. Every Accutome blade is manufactured to the highest quality and specifications inside of our Accutome facility. These lancet blades measure 1.0mm in width and come in various styles with either a straight or angled holder. Handle is aluminum with J-locking mechanism.

AK6130 **0.7mm Truncated Lancet**  
0.7mm truncated lancet blade with straight holder.



## PARACENTESIS/STAB DIAMOND KNIVES

Item #	Description	Image
AK6I50	<b>0.7mm Hawkeye Trifacet</b> 0.7mm trifacet truncated lancet blade with straight holder.	
AK6I60	<b>1.0mm Truncated Lancet</b> 1.0mm truncated lancet blade with straight holder.	
AK6I60A	<b>1.0mm Angled Truncated Lancet</b> 1.0mm truncated lancet blade with angled holder.	
AK6I75	<b>1.0mm Lancet</b> 1.0mm lancet blade with straight holder.	
AK6I75A	<b>1.0mm Angled Lancet</b> 1.0mm lancet blade with angled holder.	

## Hawkeye Premium Series

The Hawkeye Premium Series is manufactured in-house, making it a high-quality product at an affordable price. The blades measure 1.0mm in width and come in various styles. Handle is 100% titanium with J-locking mechanism and straight holders.

AK50I5	<b>1.0mm Trifacet Freehand</b> Trifacet blade with two sides sharp.	
AK6026	<b>45-Degree Single-Edge Freehand</b> 45-degree blade with one side sharp.	
AK60I6-60	<b>1.0mm Clear Cornea Lancet</b> Blade with four sides sharp.	



ASTIGMATISM MANAGEMENT DIAMOND KNIVES

Item #	Description	Image
<b>Donnenfeld Preset LRI, Long Handle</b>		
Please note that custom preset options are available. These long-handled preset Donnenfeld lancet blades are available in various desired preset specifications. Blades are at a 15-degree angle for better applanation, are 1.0mm in width, and have a winged footplate for superior control. Handle is 100% titanium and measures 4.5 inches long.		
AK6I75PT200	<b>Donnenfeld Preset LRI, 200 Micron</b> Lancet blade with 200 micron depth preset.	
AK6I75PT250	<b>Donnenfeld Preset LRI, 250 Micron</b> Lancet blade with 250 micron depth preset.	
AK6I75PT300	<b>Donnenfeld Preset LRI, 300 Micron</b> Lancet blade with 300 micron depth preset.	
AK6I75PT350	<b>Donnenfeld Preset LRI, 350 Micron</b> Lancet blade with 350 micron depth preset.	
AK6I75PT400	<b>Donnenfeld Preset LRI, 400 Micron</b> Lancet blade with 400 micron depth preset.	
AK6I75PT450	<b>Donnenfeld Preset LRI, 450 Micron</b> Lancet blade with 450 micron depth preset.	
AK6I75PT500	<b>Donnenfeld Preset LRI, 500 Micron</b> Lancet blade with 500 micron depth preset.	
AK6I75PT550	<b>Donnenfeld Preset LRI, 550 Micron</b> Lancet blade with 550 micron depth preset.	
AK6I75PT600	<b>Donnenfeld Preset LRI, 600 Micron</b> Lancet blade with 600 micron depth preset.	

<b>Donnenfeld Preset LRI, Short Handle</b>		
Please note that custom preset options are available. These short-handled preset Donnenfeld lancet blades are available in various desired preset specifications. Blades are at a 15-degree angle for better applanation, are 1.0mm in width, and have a winged footplate for superior control. Handle is 100% titanium and measures 2.625 inches long.		
AK6I75SPT200	<b>Donnenfeld Preset LRI, 200 Micron</b> Lancet blade with 200 micron depth preset.	
AK6I75SPT250	<b>Donnenfeld Preset LRI, 250 Micron</b> Lancet blade with 250 micron depth preset.	
AK6I75SPT300	<b>Donnenfeld Preset LRI, 300 Micron</b> Lancet blade with 300 micron depth preset.	
AK6I75SPT350	<b>Donnenfeld Preset LRI, 350 Micron</b> Lancet blade with 350 micron depth preset.	
AK6I75SPT400	<b>Donnenfeld Preset LRI, 400 Micron</b> Lancet blade with 400 micron depth preset.	
AK6I75SPT450	<b>Donnenfeld Preset LRI, 450 Micron</b> Lancet blade with 450 micron depth preset.	
AK6I75SPT500	<b>Donnenfeld Preset LRI, 500 Micron</b> Lancet blade with 500 micron depth preset.	
AK6I75SPT550	<b>Donnenfeld Preset LRI, 550 Micron</b> Lancet blade with 550 micron depth preset.	
AK6I75SPT600	<b>Donnenfeld Preset LRI, 600 Micron</b> Lancet blade with 600 micron depth preset.	

## ASTIGMATISM MANAGEMENT DIAMOND KNIVES

Item #	Description	Image
<b>Donnenfeld Preset Truncated Lancet, Long Handle</b>		
Please note that custom preset options are available. These long-handled preset Donnenfeld truncated lancet blades are available in various desired preset specifications. Blades are at a 15-degree angle for better appplanation, are 1.0mm in width, and have a winged footplate for superior control. Handle is 100% titanium and measures 4.5 inches long.		
AK6I60PT200	<b>Donnenfeld Preset Truncated Lancet, 200 Micron</b> Truncated lancet blade with 200 micron depth preset.	
AK6I60PT250	<b>Donnenfeld Preset Truncated Lancet, 250 Micron</b> Truncated lancet blade with 250 micron depth preset.	
AK6I60PT300	<b>Donnenfeld Preset Truncated Lancet, 300 Micron</b> Truncated lancet blade with 300 micron depth preset.	
AK6I60PT350	<b>Donnenfeld Preset Truncated Lancet, 350 Micron</b> Truncated lancet blade with 350 micron depth preset.	
AK6I60PT400	<b>Donnenfeld Preset Truncated Lancet, 400 Micron</b> Truncated lancet blade with 400 micron depth preset.	
AK6I60PT450	<b>Donnenfeld Preset Truncated Lancet, 450 Micron</b> Truncated lancet blade with 450 micron depth preset.	
AK6I60PT500	<b>Donnenfeld Preset Truncated Lancet, 500 Micron</b> Truncated lancet blade with 500 micron depth preset.	
AK6I60PT550	<b>Donnenfeld Preset Truncated Lancet, 550 Micron</b> Truncated lancet blade with 550 micron depth preset.	
AK6I60PT600	<b>Donnenfeld Preset Truncated Lancet, 600 Micron</b> Truncated lancet blade with 600 micron depth preset.	

**Donnenfeld Preset Truncated Lancet, Short Handle**

Please note that custom preset options are available. These short-handled preset Donnenfeld truncated lancet blades are available in various desired preset specifications. Blades are at a 15-degree angle for better appplanation, are 1.0mm in width, and have a winged footplate for superior control. Handle is 100% titanium and measures 2.625 inches long.

AK6I60SPT200	<b>Donnenfeld Preset Truncated Lancet, 200 Micron</b> Truncated lancet blade with 200 micron depth preset.	
AK6I60SPT250	<b>Donnenfeld Preset Truncated Lancet, 250 Micron</b> Truncated lancet blade with 250 micron depth preset.	
AK6I60SPT300	<b>Donnenfeld Preset Truncated Lancet, 300 Micron</b> Truncated lancet blade with 300 micron depth preset.	
AK6I60SPT350	<b>Donnenfeld Preset Truncated Lancet, 350 Micron</b> Truncated lancet blade with 350 micron depth preset.	
AK6I60SPT400	<b>Donnenfeld Preset Truncated Lancet, 400 Micron</b> Truncated lancet blade with 400 micron depth preset.	
AK6I60SPT450	<b>Donnenfeld Preset Truncated Lancet, 450 Micron</b> Truncated lancet blade with 450 micron depth preset.	
AK6I60SPT500	<b>Donnenfeld Preset Truncated Lancet, 500 Micron</b> Truncated lancet blade with 500 micron depth preset.	
AK6I60SPT550	<b>Donnenfeld Preset Truncated Lancet, 550 Micron</b> Truncated lancet blade with 550 micron depth preset.	
AK6I60SPT600	<b>Donnenfeld Preset Truncated Lancet, 600 Micron</b> Truncated lancet blade with 600 micron depth preset.	

ASTIGMATISM MANAGEMENT DIAMOND KNIVES

Item #	Description	Image
--------	-------------	-------

**Chang LRI Diamond Knife**

A 1.0mm wide lancet blade developed specifically for correcting astigmatism using an intraoperative wavefront aberrometer. Customized, 3.5-inch, gold, aluminum, straight handle design to provide better control within shorter working distance. Winged footplate provides superior visualization and reduces epithelium drag. Highest quality preset diamond blade. Fully retractable J-locking mechanism for blade and sharps protection.

AK6I75PC **Chang LRI Diamond Knife**

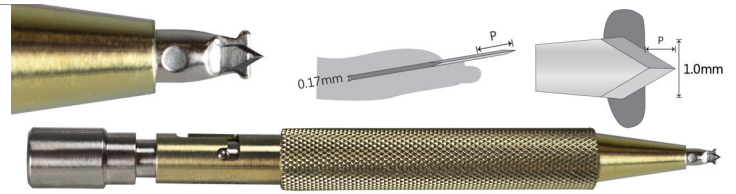

**Rubenstein Preset LRI, Long Handle**

Please note that custom preset options are available. These long-handed Rubenstein Preset LRI lancet diamond knives measure 1.0mm in width and are available in various desired preset specifications. Winged footplate for superior control. Handle is straight aluminum and measures 4.75 inches long.

AK6I75P200 **Rubenstein Preset LRI, 200 Micron**  
Lancet blade with 200 micron depth preset.

AK6I75P250 **Rubenstein Preset LRI, 250 Micron**  
Lancet blade with 250 micron depth preset.

AK6I75P300 **Rubenstein Preset LRI, 300 Micron**  
Lancet blade with 300 micron depth preset.

AK6I75P350 **Rubenstein Preset LRI, 350 Micron**  
Lancet blade with 350 micron depth preset.

AK6I75P400 **Rubenstein Preset LRI, 400 Micron**  
Lancet blade with 400 micron depth preset.

AK6I75P450 **Rubenstein Preset LRI, 450 Micron**  
Lancet blade with 450 micron depth preset.

AK6I75P500 **Rubenstein Preset LRI, 500 Micron**  
Lancet blade with 500 micron depth preset.

AK6I75P550 **Rubenstein Preset LRI, 550 Micron**  
Lancet blade with 550 micron depth preset.

AK6I75P600 **Rubenstein Preset LRI, 600 Micron**  
Lancet blade with 600 micron depth preset.

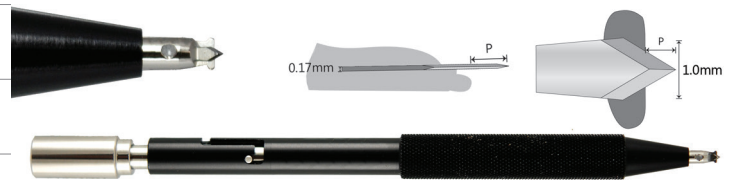

## ASTIGMATISM MANAGEMENT DIAMOND KNIVES

Item #	Description	Image
<b>Rubenstein Preset Truncated Lancet, Long Handle</b>		
Please note that custom preset options are available. These long-handled Rubenstein Preset truncated lancet diamond knives measure 1.0mm in width and are available in various desired preset specifications. Winged footplate for superior control. Handle is straight aluminum and measures 4.75 inches long.		
AK6I60P200	<b>Rubenstein Preset Truncated Lancet, 200 Micron</b> Truncated lancet blade with 200 micron depth preset.	
AK6I60P250	<b>Rubenstein Preset Truncated Lancet, 250 Micron</b> Truncated lancet blade with 250 micron depth preset.	
AK6I60P300	<b>Rubenstein Preset Truncated Lancet, 300 Micron</b> Truncated lancet blade with 300 micron depth preset.	
AK6I60P350	<b>Rubenstein Preset Truncated Lancet, 350 Micron</b> Truncated lancet blade with 350 micron depth preset.	
AK6I60P400	<b>Rubenstein Preset Truncated Lancet, 400 Micron</b> Truncated lancet blade with 400 micron depth preset.	
AK6I60P450	<b>Rubenstein Preset Truncated Lancet, 450 Micron</b> Truncated lancet blade with 450 micron depth preset.	
AK6I60P500	<b>Rubenstein Preset Truncated Lancet, 500 Micron</b> Truncated lancet blade with 500 micron depth preset.	
AK6I60P550	<b>Rubenstein Preset Truncated Lancet, 550 Micron</b> Truncated lancet blade with 550 micron depth preset.	
AK6I60P600	<b>Rubenstein Preset Truncated Lancet, 600 Micron</b> Truncated lancet blade with 600 micron depth preset.	

**Rubenstein Preset LRI, Short Handle**

Please note that custom preset options are available. These short-handled Rubenstein Preset LRI lancet diamond knives measure 1.0mm in width and are available in various desired preset specifications. Winged footplate for superior control. Handle is straight aluminum and measures 2.75 inches long.

AK6I75SP200	<b>Rubenstein Preset LRI, 200 Micron</b> Lancet blade with 200 micron depth preset.	
AK6I75SP250	<b>Rubenstein Preset LRI, 250 Micron</b> Lancet blade with 250 micron depth preset.	
AK6I75SP300	<b>Rubenstein Preset LRI, 300 Micron</b> Lancet blade with 300 micron depth preset.	
AK6I75SP350	<b>Rubenstein Preset LRI, 350 Micron</b> Lancet blade with 350 micron depth preset.	
AK6I75SP400	<b>Rubenstein Preset LRI, 400 Micron</b> Lancet blade with 400 micron depth preset.	
AK6I75SP450	<b>Rubenstein Preset LRI, 450 Micron</b> Lancet blade with 450 micron depth preset.	
AK6I75SP500	<b>Rubenstein Preset LRI, 500 Micron</b> Lancet blade with 500 micron depth preset.	
AK6I75SP550	<b>Rubenstein Preset LRI, 550 Micron</b> Lancet blade with 550 micron depth preset.	

ASTIGMATISM MANAGEMENT DIAMOND KNIVES

Item #	Description	Image
AK6175SP600	<b>Rubenstein Preset LRI, 600 Micron</b> Lancet blade with 600 micron depth preset.	

Surgeon's Choice Adjustable

Please note that any diamond knife orders will be processed as separate orders in house. Other pre-set options are available upon request. Blade with various adjustable pre-set handle steps. Blade measures 1.0mm in width and each knife has a wide footplate design. Handle is 100% titanium and has a straight holder.

AK6216	<b>1.0mm Clear Cornea Blade</b> Clear cornea blade with adjustable steps - 0.5mm, 0.55mm, 0.6mm, and full extension.	
AK6235-2	<b>1.0mm Double Preset Lancet Blade</b> Lancet blade with two pre-set adjustable steps - 0.3mm and 0.6mm.	
AK6235-3	<b>1.0mm Triple Preset Lancet Blade</b> Lancet blade with three preset adjustable steps - 0.5mm, 0.55mm, and 0.6mm.	

Micrometer

Variety of 1.0mm blade styles mounted in an adjustable micrometer handle. Dual footplate for superior control. 100% titanium handle.

AK5003	<b>15-Degree Micrometer</b> 15-Degree Arcuate Blade mounted in an adjustable micrometer handle.	
AK5002	<b>45-Degree Micrometer</b> Single edge, 45-degree RK Blade mounted in an adjustable micrometer handle.	
AK5005	<b>45-Degree Micrometer</b> Double edge, 45-degree blade mounted in an adjustable micrometer handle.	



## ASTIGMATISM MANAGEMENT DIAMOND KNIVES

Item #	Description	Image
AK5004	<p><b>Tri-Square Micrometer</b></p> <p>Tri-Square (Triple 90) Blade mounted in an adjustable micrometer handle.</p>	
AK5017	<p><b>Triple 90 Micrometer</b></p> <p>Tri-Square (Triple 90) Blade mounted in an adjustable micrometer handle. 250 micron cutting depth.</p>	

# Sapphire Knives



## KERATOME SAPPHIRE KNIVES

Item #	Description	Image
<b>Clear Cornea Sapphire Knife</b>		
Variety of sapphire blade widths. Aluminum handle with J-locking mechanism and angled holder.		
AK0018L	<b>1.5mm Clear Cornea Sapphire</b> 1.5mm wide clear cornea blade.	
AK0019L	<b>2.2mm Clear Cornea Sapphire</b> 2.2mm wide clear cornea blade.	
AK0011L	<b>2.8mm Clear Cornea Sapphire</b> 2.8mm wide clear cornea blade.	
AK0012L	<b>3.0mm Clear Cornea Sapphire</b> 3.0mm wide clear cornea blade.	
AK0013L	<b>3.2mm Clear Cornea Sapphire</b> 3.2mm wide clear cornea blade.	
<b>Spear Sapphire Knife</b>		
Variety of sapphire blade widths. Aluminum handle with J-locking mechanism and angled holder.		
AK0001L	<b>2.8mm Lance Sapphire Knife</b> 2.8mm wide spear blade.	
AK0002L	<b>3.0mm Lance Sapphire Knife</b> 3.0mm wide spear blade.	
AK0003L	<b>3.2mm Lance Sapphire Knife</b> 3.2mm wide spear blade.	
<b>Trapezoid Sapphire Knife</b>		
Four sharp-sided, trapezoid-shaped blades with two different blade widths allowing for a small or large incision. Aluminum handle with J-locking mechanism and angled holder.		
AK0038	<b>0.9mm/1.2mm Trapezoid Sapphire</b> 0.9mm width at front of blade (width 1) and 1.2mm width blade at back of blade (width 2).	
AK0025	<b>2.2mm/2.5mm Trapezoid Sapphire</b> 2.2mm width at front of blade (width 1) and 2.5mm width blade at back of blade (width 2).	
AK0061	<b>2.5mm/3.0mm Trapezoid Sapphire</b> 2.5mm width at front of blade (width 1) and 3.0mm width blade at back of blade (width 2).	
AK0060	<b>2.5mm/3.2mm Trapezoid Sapphire</b> 2.5mm width at front of blade (width 1) and 3.2mm width blade at back of blade (width 2).	

**CRESCENT SAPPHIRE KNIVES**

Item #	Description	Image
<b>Crescent Sapphire Knife</b>		
2.0mm crescent blade. Aluminum handle with J-locking mechanism. Angled holder.		
AK0041	<b>2.0mm Crescent Sapphire</b>	

**SAPPHIRE STAB KNIVES**

Item #	Description	Image
<b>Lancet Sapphire Knife</b>		
1.0mm lance blade. Aluminum handle with J-locking mechanism. Straight holder.		
AK0035	<b>1.0mm Lance Sapphire</b>	

<b>Single-Edge Sapphire Knife</b>		
1.0mm single-edge blade. Aluminum handle with J-locking mechanism. Straight holder.		
AK0009	<b>1.0mm Single-Edge Sapphire</b>	

<b>Trifacet Sapphire Knife</b>		
1.0mm trifacet blade. Aluminum handle with J-locking mechanism. Straight holder.		
AK0010	<b>1.0mm Trifacet Sapphire</b>	

# We Have You Covered

Accutome provides a wide range of repair services including: Phaco Handpiece, Handheld Instrument, and Diamond Knives (all brands and all styles). Accutome can also repair a long list of ultrasound equipment. Our experienced staff provides quality, professional service utilizing technologically advanced in-house repair facilities.

## Specific Repair Services Include:

### Phaco Handpiece Repair

- Servicing all major brands, with 6- or 12-month warranty, 5-day repair turnaround.
- Refurbished handpieces available in most makes and models.

### Diamond Knife Repair

- Any size and any style knife can be repaired, usually within 24 hours. We will refurbish your old handles when your diamond blades are repaired.
- Diamond Exchange Program allows you to upgrade or change blade designs and sizes as your incisional needs change. Accutome will replace the older blade in your diamond knife with a new state-of-the-art Clear Cornea, Simplicity one pass, or Phaco blade for the price of a repair.
- Exact Size Guarantee within 60 days of a diamond knife purchase, Accutome adjusts diamond widths at no extra charge should the surgeon require a larger or smaller incision.

### Instrument Repair

- Any handheld surgical instrument can be repaired.
- Forceps – straightening, aligning, and remanufacturing forceps teeth.
- Scissors – sharpening and refurbishing
- Hooks and manipulators
- Needle holders
- Speculums

### Handpieces

- Most makes and models

### Camera Repair

Servicing many brands, including:

- Stryker
- Storz
- Dyonics
- Olympus
- Linvatec





# Bipolar Instruments

**BIPOLAR CABLES & PROBES**

Item #	Description	Image
--------	-------------	-------

**Bipolar Cables**

Reusable TPR (thermoplastic rubber) bipolar cables 12 inches, straight connection, universal 2 pin fitting. Fits 4mm banana-plug style generators. Good for use with steam sterilization.

AM0830	<p><b>Straight Bipolar Cable</b> Straight connector.</p>	
--------	--	--

AM0831	<p><b>Angled Bipolar Cable</b> 45-degree connector.</p>	
--------	---	---

**Cautery Probe**

Straight tip. Reusable.



AF0160	<p><b>Cautery Probe 18g</b> 18 gauge probe.</p>	
AF0162	<p><b>Cautery Probe 20g</b> 20 gauge probe.</p>	

**BIPOLAR FORCEPS**



Item #	Description	Image
--------	-------------	-------

**Adson Bipolar Forceps**

Straight shafts, 1.0mm wide tips. Flat handle. Overall length: 127mm.

AF0125	<p><b>Adson Bipolar Forceps, Straight</b> 1.0mm wide serrated tips. Insulated handle. Overall length: 127mm.</p>	
AF0127	<p><b>Adson Bipolar Forceps, Straight</b> 1.0mm wide non-stick tips. Overall length: 127mm.</p>	

**BIPOLAR FORCEPS**

Item #	Description	Image
<b>Coaptation Bipolar Forceps</b>		
Curved shafts, angled 0.6mm wide non-stick tips, wide, flat handle. Non-insulated. Overall length: 114mm.		
AF0100	<b>Coaptation Bipolar Forceps</b>	
<b>Jewelers Bipolar Forceps</b>		
Straight shafts with fine pointed tips. Smooth handle with dull finish. Overall length: 120mm.		
AF0120	<b>Non-insulated Jewelers Bipolar Forceps</b> Non-insulated.	
AF0120 IN	<b>Insulated Jewelers Bipolar Forceps</b> Insulated.	
<b>McPherson Bipolar Forceps</b>		
Straight and angled shafts, 0.4mm wide non-stick tips. Flat handle. Overall length: 95mm.		
AF0130	<b>McPherson Bipolar Forceps, Angled</b> Angled shafts, non-insulated.	
AF0130 I	<b>McPherson Bipolar Forceps, Angled</b> Angled shafts, insulated.	
AF0140	<b>McPherson Bipolar Forceps, Straight</b> Straight shafts, non-insulated.	

**BIPOLAR FORCEPS**

Item #	Description	Image
<b>Shepard Bipolar Forceps</b>		
Angled shafts with 4mm platform. Smooth handle with dull finish. Non-insulated. Overall length: 120mm.		
AF0145 A	<a href="#">Shepard Bipolar Forceps</a>	

# Calipers, Gauges & Markers



CALIPERS

Item #	Description	Image
--------	-------------	-------

**Braunstein Fixed Caliper**

Aphakic: 3.5mm. Phakic: 4mm. Overall length: 80mm.

AR0155	<a href="#">Braunstein Fixed Caliper</a>
--------	--



**Castroviejo Caliper**

Measures 0mm-20mm in 1.0mm increments. Screw-locking mechanism. Overall length: 89mm.

AR0140	<a href="#">Castroviejo Caliper</a> Curved blades.
--------	---



AR0150	<a href="#">Castroviejo Caliper</a> Straight blades.
--------	---



AR0150TI	<a href="#">Castroviejo Caliper</a> Straight titanium blades.
----------	--



**Jameson Caliper**

Angled tips, measures 0mm to 80mm with 1.0mm increments. Overall length: 95mm.



AR0260	<a href="#">Jameson Caliper</a>
--------	---------------------------------

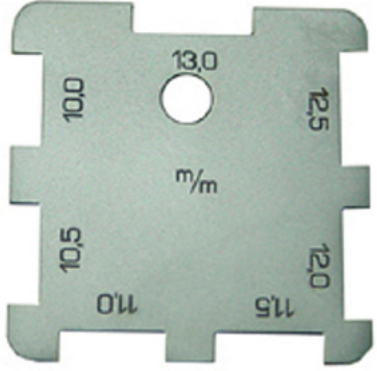

CALIPERS

Item #	Description	Image
<b>Stahl Corneal Caliper</b>		
Measures 10-13mm in 0.5mm increments.		
AR0380	<a href="#">Stahl Caliper</a>	

GAUGES

Item #	Description	Image
<b>Mendez Degree Gauge</b>		
Outside diameter 18mm. Inside diameter 12mm. Markings on top of instrument, 10-degree increments. Round handle. Overall length: 114mm.		
AR0121	<a href="#">Stainless Steel Gauge</a> Made from stainless steel.	
AR0121TI	<a href="#">Titanium Gauge</a> Made from titanium.	

MARKERS

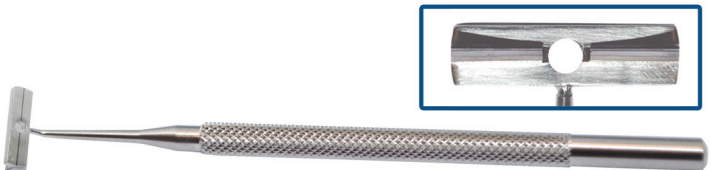
Item #	Description	Image
<b>Bores Axis Marker</b>		
Designed to fit inside of degree gauge for axis marking. Round handle.		
AR0120	<a href="#">Bores Axis Marker</a>	

MARKERS

Item #	Description	Image
--------	-------------	-------

**Chayet Marker**

Stainless steel corneal marker that is to be used during LASIK surgery for identifying and realigning the lamellar flap. Marking pattern uses a small, medium, and large circle. Flat handle. Overall length: 106mm.

AR4120	<b>Chayet Marker</b>	
--------	----------------------	---



**Dell LRI Astigmatism Marker**

Titanium with axis marking blades. Rotating ring with 10 degree increments. Round, knurled handle. Overall length: 120mm.

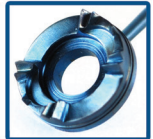
AR0126	<b>Gills Nomogram Marker</b>	 
6mm and 8mm chord length and axis marking blades.		

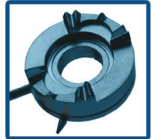

AR0127	<b>Nichamin Nomogram Marker</b>	 
40, 60, 80 degrees and axis marking blades.		

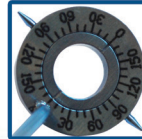
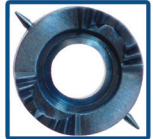

AR0129	<b>Nichamin Nomogram Marker</b>	 
40, 60, 80 degrees and axis marking blades. Reference marks for proper positioning.		



AR0132	<b>Donnenfeld LRI Marker</b>	 
1, 2 clock hours (30, 60 degrees) and axis marking blades.		



MARKERS

Item #	Description	Image
--------	-------------	-------

**Devgan Axis Marker**

The Devgan Axis Markers are designed to improve toric IOL axis and centration accuracy for better outcomes. The marking blades fit most standard goldman tonometer housings. Hollow center allows surgeon to center marks with pupil without the use of gentian violet ink. Markers are 6mm or 9mm on the inside of the blades and 9 to 12mm on the outside. Markers are either smooth and angled or pointed and angled. Marks 0 to 180 degrees in 10-degree increments.

AR8000 **6-9mm Marking Blade**  
 Marking blades are 6mm apart on the inside and 9mm apart on the outside. Tips of marker are smooth and angled.

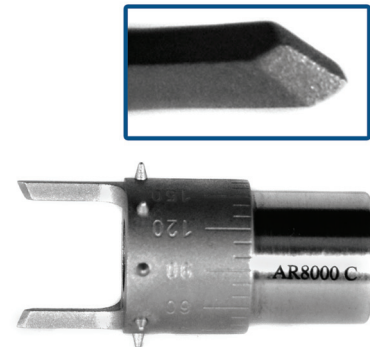

AR8001 **9-12mm Marking Blade**  
 Marking blades are 9mm apart on the inside and 12mm apart on the outside. Tips of marker are smooth and angled.

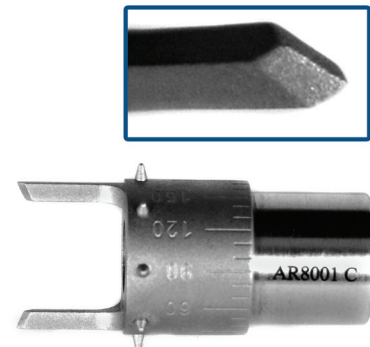

AR8002 **6-9mm Marking Blade**  
 Marking blades are 6mm apart on the inside and 9mm apart on the outside. Tips of marker have three points and are angled. This tip will leave three dots on each side and is used for toric IOL marking.

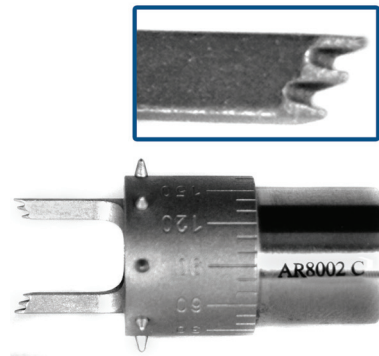

**Hoffer Optical Zone Marker**

Various marker diameters with cross hairs. Round handle. Overall length: 108mm.

AR0250 4.00 **4mm Optical Zone Marker**  
 4.0mm diameter with cross hairs.

AR0250 4.50 **4.5mm Optical Zone Marker**  
 4.5mm diameter with cross hairs.

AR0250 5.00 **5.0mm Optical Zone Marker**  
 5.0mm diameter with cross hairs.



MARKERS

Item #	Description	Image
AR0250 5.50	<b>5.5mm Optical Zone Marker</b> 5.5mm diameter with cross hairs.	
AR0250 5.75	<b>5.75mm Optical Zone Marker</b> 5.75mm diameter with cross hairs.	
AR0250 6.00	<b>6.0mm Optical Zone Marker</b> 6.0mm diameter with cross hairs.	
AR0250 8.00	<b>8.0mm Optical Zone Marker</b> 8.0mm diameter with cross hairs.	
AR0250 8.5	<b>8.5mm Optical Zone Marker</b> 8.5mm diameter with cross hairs.	
AR0250 9.00	<b>9.0mm Optical Zone Marker</b> 9.0mm diameter with cross hairs.	

**LASIK Corneal Marker**

Three marking blades. Round handle.

AR4130	<b>LASIK Corneal Marker</b>	
--------	-----------------------------	---

**Osher-Neumann Radial Incision Marker**

Marking blades, low profile. Round handle.

AR0400 8	<b>Osher-Neumann Radial Marker</b> 8 marking blades.	
AR0400 12	<b>Osher-Neumann Radial Marker</b> 12 marking blades.	



MARKERS

Item #	Description	Image
--------	-------------	-------

**Plain Optical Zone Marker**

Open circle tip with various diameter sizes and low profile design. Round Handle. Overall length: 95mm.

AR0370 2.50	<b>2.5mm Optical Zone Marker</b> 2.5mm diameter.
AR0370 3.00	<b>3.0mm Optical Zone Marker</b> 3.0mm diameter.
AR0370 3.50	<b>3.5mm Optical Zone Marker</b> 3.5mm diameter.
AR0370 4.00	<b>4.0mm Optical Zone Marker</b> 4.0mm diameter.
AR0370 5.00	<b>5.0mm Optical Zone Marker</b> 5.0mm diameter.
AR0370 5.75	<b>5.75mm Optical Zone Marker</b> 5.75mm diameter.
AR0370 6.00	<b>6.0mm Optical Zone Marker</b> 6.0mm diameter.
AR0370 7.00	<b>7.0mm Optical Zone Marker</b> 7.0mm diameter.
AR0370 8.00	<b>8.0mm Optical Zone Marker</b> 8.0mm diameter.
AR0370 9.00	<b>9.0mm Optical Zone Marker</b> 9.0mm diameter.

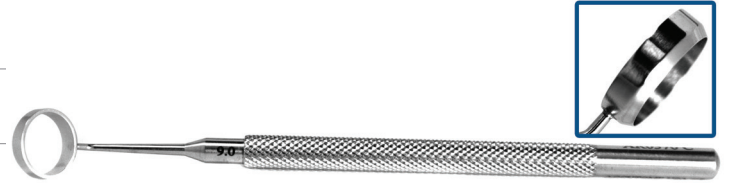

**Rubenstein LASIK Corneal Marker**

Five marking blades. Flat handle.

AR4150	<b>Rubenstein LASIK Corneal Marker</b>
--------	--



**Toric Lens Marker**

Titanium. Axis marking blades. Rotating ring with 10-degree increments. Round, knurled handle.

AR0146	<b>Toric Lens Marker</b> Overall length: 127mm.
AR0148	<b>Toric Lens Marker</b> Overall length: 120mm.

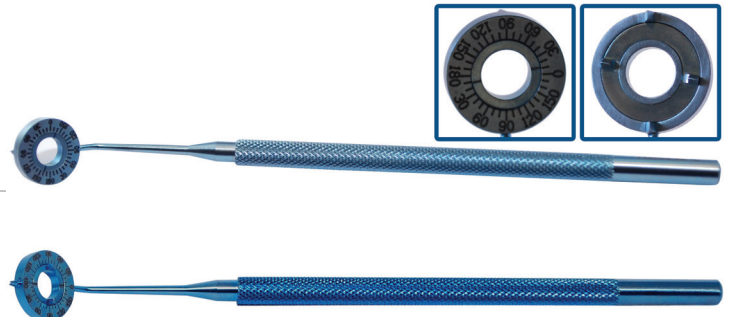

## MARKERS

Item #	Description	Image
<b>Toric Reference Marker</b>		
Three marking blades at 0, 90, and 180 degrees. 15mm diameter. Designed for marking with patient in the upright position.		
AR0145	<a href="#">Toric Reference Marker</a>	

# Cannulas & Cystotomes

ACCUSURGICAL SINGLE-USE CANNULAS & CYSTOTOMES

Item #	Description	Image
--------	-------------	-------

**Atkinson Retrobulbar Needle**

The Atkinson Retrobulbar Needle has a straight shaft and needle tip. Disposable, sold 10 per box. Overall length: 38mm.

AXI0414	<b>Retrobulbar Needle, 23g</b> 23 gauge.
AXIII637	<b>Retrobulbar Needle, 25g</b> 25 gauge.
AXI4571	<b>Retrobulbar Needle, 27g</b> 27 gauge.

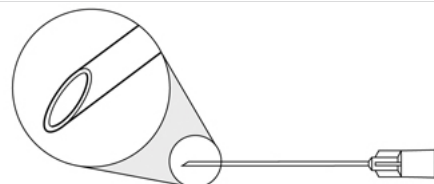

**Atkinson Peribulbar Needle**

The AccuSurgical disposable Atkinson Peribulbar Needle has a straight shaft and needle tip. Available between 16mm and 32mm total length and 23 to 27 gauge. Sold 10 per box.

AXI4576	<b>Peribulbar Needle, 23g</b> 23 gauge. Overall length: 16mm.
AXI4577	<b>Peribulbar Needle, 23g</b> 23 gauge. Overall length: 22mm.
AXI0853	<b>Peribulbar Needle, 23g</b> 23 gauge. Overall length: 32mm.
AXI4572	<b>Peribulbar Needle, 25g</b> 25 gauge. Overall length: 16mm.
AXII5027	<b>Peribulbar Needle, 25g</b> 25 gauge. Overall length: 22mm.
AXIII642	<b>Peribulbar Needle, 25g</b> 25 gauge. Overall length: 32mm.
AXI4568	<b>Peribulbar Needle, 27g</b> 27 gauge. Overall length: 22mm.
AXI2045	<b>Peribulbar Needle, 27g</b> 27 gauge. Overall length: 32mm.

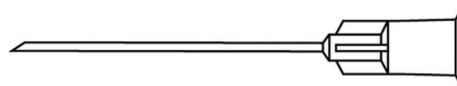

**Non Atkinson Retrobulbar Needle**

The AccuSurgical disposable Non Atkinson Retrobulbar Needle has a straight shaft and needle tip. Available between 25 to 27 gauge with an overall length of 38mm. Sold 10 per box.

AXI4580	<b>Non Atkinson Retrobulbar Needle, 25g</b> 25 gauge.
AXI4581	<b>Non Atkinson Retrobulbar Needle, 26g</b> 26 gauge.
AXI4582	<b>Non Atkinson Retrobulbar Needle, 27g</b> 27 gauge.

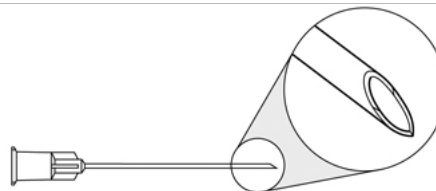

**ACCUSURGICAL SINGLE-USE CANNULAS & CYSTOTOMES**

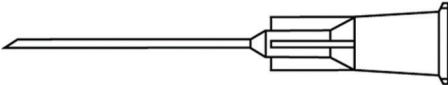
Item #	Description	Image
<b>Non Atkinson Peribulbar Needle</b>		
The AccuSurgical disposable Non Atkinson Peribulbar Needle has a straight shaft and needle tip. Available between 23 to 30 gauge and 16mm to 25mm in overall length. Sold 10 per box.		
AXI4585	<b>Non Atkinson Peribulbar Needle, 23g</b> 23 gauge. Overall length: 16mm.	
AXI4586	<b>Non Atkinson Peribulbar Needle, 25g</b> 25 gauge. Overall length: 16mm.	
AXI4584	<b>Non Atkinson Peribulbar Needle, 25g</b> 25 gauge. Overall length: 22mm.	
AXI4583	<b>Non Atkinson Peribulbar Needle, 25g</b> 25 gauge. Overall length: 25mm.	
AXI4587	<b>Non Atkinson Peribulbar Needle, 27g</b> 27 gauge. Overall length: 16mm.	
AXI4588	<b>Non Atkinson Peribulbar Needle, 30g</b> 30 gauge. Overall length: 16mm.	

**Sub Tenon Anesthesia Cannula**

The AccuSurgical disposable Sub Tenon Anesthesia Cannula has either a curved or angled shaft with various tip types. Available in 19 or 21 gauge and 22mm to 25mm in overall length. Sold 10 per box.

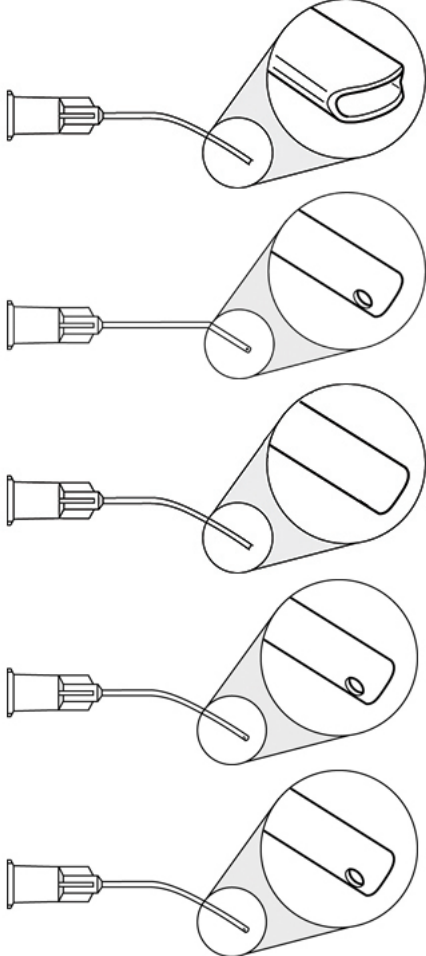
AXI0914	<b>Sub Tenon Cannula, 19g</b> 19 gauge, curved shaft, flattened tip. Overall length: 25mm.	
AXI4593	<b>Sub Tenon Cannula, 19g</b> 19 gauge, angled shaft, 7mm from bend to tip, blunt tip, tri port. Overall length: 25mm.	
AXI25176	<b>Sub Tenon Cannula, 19g</b> 19 gauge, curved shaft, open tip. Overall length: 22mm.	
AXI4592	<b>Sub Tenon Cannula, 19g</b> 19 gauge, curved shaft, blunt tip, tri port. Overall length: 25mm.	
AXI4590	<b>Sub Tenon Cannula, 21g</b> 21 gauge, curved shaft, blunt tip, tri port. Overall length: 22mm.	



ACCUSURGICAL SINGLE-USE CANNULAS & CYSTOTOMES

Item #	Description	Image
AXI4591	<p><b>Sub Tenon Cannula, 21g</b></p> <p>21 gauge, angled shaft, 7mm from bend to tip, blunt tip, tri port. Overall length: 22mm.</p>	

**Rous Sub Tenon/Parabulbar Needle**

19 gauge, angled shaft, 7mm from bend to tip, needle tip, tri port. Disposable, sold 10 per box. Overall length: 25mm.

AXI4594	<p><b>Rous Sub Tenon/Parabulbar Needle, 19g</b></p>	
---------	---	--

**Anterior Chamber Cannula, Angled**

Our single-use Anterior Chamber Cannula, also known as Air Injection, Rycroft, and Viscoelastic cannula, is available from 19 to 30 gauge. Every cannula has a 32-degree angled shaft with blunt and polished tips for smoother radii. Overall length ranges from 22mm to 25mm. Sold 10 per box, unless specified otherwise.

AXI4655	<p><b>Anterior Chamber Cannula, 19g</b></p> <p>19 gauge, 3mm from bend to tip. Overall length: 25mm.</p>	  <table border="1"> <thead> <tr> <th>3mm</th> <th>4mm</th> <th>5mm</th> <th>6mm</th> <th>7mm</th> <th>8mm</th> <th>9mm</th> <th>10mm</th> <th>11mm</th> <th>12mm</th> </tr> </thead> <tbody> <tr> <td></td> <td></td> <td></td> <td></td> <td></td> <td></td> <td></td> <td></td> <td></td> <td></td> </tr> </tbody> </table>	3mm	4mm	5mm	6mm	7mm	8mm	9mm	10mm	11mm	12mm										
3mm	4mm		5mm	6mm	7mm	8mm	9mm	10mm	11mm	12mm												
AXI4656	<p><b>Anterior Chamber Cannula, 19g</b></p> <p>19 gauge, 4mm from bend to tip. Overall length: 25mm.</p>																					
AXI4657	<p><b>Anterior Chamber Cannula, 19g</b></p> <p>19 gauge, 5mm from bend to tip. Overall length: 25mm.</p>																					
AXI4658	<p><b>Anterior Chamber Cannula, 19g</b></p> <p>19 gauge, 6mm from bend to tip. Overall length: 25mm.</p>																					
AXI4659	<p><b>Anterior Chamber Cannula, 19g</b></p> <p>19 gauge, 7mm from bend to tip. Overall length: 25mm.</p>																					
AXI4660	<p><b>Anterior Chamber Cannula, 19g</b></p> <p>19 gauge, 8mm from bend to tip. Overall length: 25mm.</p>																					
AXI4661	<p><b>Anterior Chamber Cannula, 19g</b></p> <p>19 gauge, 9mm from bend to tip. Overall length: 25mm.</p>																					
AXI4662	<p><b>Anterior Chamber Cannula, 19g</b></p> <p>19 gauge, 10mm from bend to tip. Overall length: 25mm.</p>																					
AXI4663	<p><b>Anterior Chamber Cannula, 19g</b></p> <p>19 gauge, 11mm from bend to tip. Overall length: 25mm.</p>																					
AXI4664	<p><b>Anterior Chamber Cannula, 19g</b></p> <p>19 gauge, 12mm from bend to tip. Overall length: 25mm.</p>																					
AXI4645	<p><b>Anterior Chamber Cannula, 20g</b></p> <p>20 gauge, 3mm from bend to tip. Overall length: 25mm.</p>																					
AXI4646	<p><b>Anterior Chamber Cannula, 20g</b></p> <p>20 gauge, 4mm from bend to tip. Overall length: 25mm.</p>																					
AXI4647	<p><b>Anterior Chamber Cannula, 20g</b></p> <p>20 gauge, 5mm from bend to tip. Overall length: 25mm.</p>																					
AXI4648	<p><b>Anterior Chamber Cannula, 20g</b></p> <p>20 gauge, 6mm from bend to tip. Overall length: 25mm.</p>																					

## ACCUSURGICAL SINGLE-USE CANNULAS &amp; CYSTOTOMES

Item #	Description	Image
AXI21277B	<b>Anterior Chamber Cannula, 20g</b> 20 gauge, 7mm from bend to tip. Overall length: 25mm.	
AXI261	<b>Anterior Chamber Cannula, 20g</b> 20 gauge, 8mm from bend to tip. Overall length: 25mm.	
AXI4651	<b>Anterior Chamber Cannula, 20g</b> 20 gauge, 9mm from bend to tip. Overall length: 25mm.	
AXI4652	<b>Anterior Chamber Cannula, 20g</b> 20 gauge, 10mm from bend to tip. Overall length: 25mm.	
AXI4653	<b>Anterior Chamber Cannula, 20g</b> 20 gauge, 11mm from bend to tip. Overall length: 25mm.	
AXI4654	<b>Anterior Chamber Cannula, 20g</b> 20 gauge, 12mm from bend to tip. Overall length: 25mm.	
AXI4635	<b>Anterior Chamber Cannula, 21g</b> 21 gauge, 3mm from bend to tip. Overall length: 22mm.	
AXI4636	<b>Anterior Chamber Cannula, 21g</b> 21 gauge, 4mm from bend to tip. Overall length: 22mm.	
AXI4637	<b>Anterior Chamber Cannula, 21g</b> 21 gauge, 5mm from bend to tip. Overall length: 22mm.	
AXI4638	<b>Anterior Chamber Cannula, 21g</b> 21 gauge, 6mm from bend to tip. Overall length: 22mm.	
AXI4639	<b>Anterior Chamber Cannula, 21g</b> 21 gauge, 7mm from bend to tip. Overall length: 22mm.	
AXI4640	<b>Anterior Chamber Cannula, 21g</b> 21 gauge, 8mm from bend to tip. Overall length: 22mm.	
AXI4641	<b>Anterior Chamber Cannula, 21g</b> 21 gauge, 9mm from bend to tip. Overall length: 22mm.	
AXI4642	<b>Anterior Chamber Cannula, 21g</b> 21 gauge, 10mm from bend to tip. Overall length: 22mm.	
AXI4643	<b>Anterior Chamber Cannula, 21g</b> 21 gauge, 11mm from bend to tip. Overall length: 22mm.	
AXI4644	<b>Anterior Chamber Cannula, 21g</b> 21 gauge, 12mm from bend to tip. Overall length: 22mm.	
AXI4625	<b>Anterior Chamber Cannula, 23g</b> 23 gauge, 3mm from bend to tip. Overall length: 22mm.	
AXI3254	<b>Anterior Chamber Cannula, 23g</b> 23 gauge, 4mm from bend to tip. Overall length: 22mm.	
AXI4627	<b>Anterior Chamber Cannula, 23g</b> 23 gauge, 5mm from bend to tip. Overall length: 22mm.	
AXI4628	<b>Anterior Chamber Cannula, 23g</b> 23 gauge, 6mm from bend to tip. Overall length: 22mm.	
AXI4629	<b>Anterior Chamber Cannula, 23g</b> 23 gauge, 7mm from bend to tip. Overall length: 22mm.	
AXI4630	<b>Anterior Chamber Cannula, 23g</b> 23 gauge, 8mm from bend to tip. Overall length: 22mm.	

## ACCUSURGICAL SINGLE-USE CANNULAS &amp; CYSTOTOMES

Item #	Description	Image
AXI4631	<b>Anterior Chamber Cannula, 23g</b> 23 gauge, 9mm from bend to tip. Overall length: 22mm.	
AXI4632	<b>Anterior Chamber Cannula, 23g</b> 23 gauge, 10mm from bend to tip. Overall length: 22mm.	
AXI4633	<b>Anterior Chamber Cannula, 23g</b> 23 gauge, 11mm from bend to tip. Overall length: 22mm.	
AXI4634	<b>Anterior Chamber Cannula, 23g</b> 23 gauge, 12mm from bend to tip. Overall length: 22mm.	
AXI4615	<b>Anterior Chamber Cannula, 25g</b> 25 gauge, 3mm from bend to tip. Overall length: 22mm.	
AXI21639	<b>Anterior Chamber Cannula, 25g</b> 25 gauge, 4mm from bend to tip. Overall length: 22mm.	
AXI4617	<b>Anterior Chamber Cannula, 25g</b> 25 gauge, 5mm from bend to tip. Overall length: 22mm.	
AXI2080	<b>Anterior Chamber Cannula, 25g</b> 25 gauge, 6mm from bend to tip. Overall length: 22mm.	
AXI4619	<b>Anterior Chamber Cannula, 25g</b> 25 gauge, 7mm from bend to tip. Overall length: 22mm.	
AXI21638	<b>Anterior Chamber Cannula, 25g</b> 25 gauge, 8mm from bend to tip. Overall length: 22mm.	
AXI4621	<b>Anterior Chamber Cannula, 25g</b> 25 gauge, 9mm from bend to tip. Overall length: 22mm.	
AXI21280	<b>Anterior Chamber Cannula, 25g</b> 25 gauge, 10mm from bend to tip. Overall length: 22mm.	
AXI4623	<b>Anterior Chamber Cannula, 25g</b> 25 gauge, 11mm from bend to tip. Overall length: 22mm.	
AXI4624	<b>Anterior Chamber Cannula, 25g</b> 25 gauge, 12mm from bend to tip. Overall length: 22mm.	
AXI4605	<b>Anterior Chamber Cannula, 27g</b> 27 gauge, 3mm from bend to tip. Overall length: 22mm.	
AXI21273A	<b>Anterior Chamber Cannula, 27g</b> 27 gauge, 4mm from bend to tip. Overall length: 22mm.	
AXI21273A-BULK	<b>Anterior Chamber Cannula, 27g</b> 27 gauge, 4mm from bend to tip. Overall length: 22mm. Sold 100 per bag.	
AXI4607	<b>Anterior Chamber Cannula, 27g</b> 27 gauge, 5mm from bend to tip. Overall length: 22mm.	
AXI21276A	<b>Anterior Chamber Cannula, 27g</b> 27 gauge, 6mm from bend to tip. Overall length: 22mm.	
AXI1463	<b>Anterior Chamber Cannula, 27g</b> 27 gauge, 7mm from bend to tip. Overall length: 22mm.	
AXI1956	<b>Anterior Chamber Cannula, 27g</b> 27 gauge, 8mm from bend to tip. Overall length: 22mm.	
AXI4611	<b>Anterior Chamber Cannula, 27g</b> 27 gauge, 9mm from bend to tip. Overall length: 22mm.	

## ACCUSURGICAL SINGLE-USE CANNULAS &amp; CYSTOTOMES

Item #	Description	Image
AXI21274	<b>Anterior Chamber Cannula, 27g</b> 27 gauge, 10mm from bend to tip. Overall length: 22mm.	
AXI4613	<b>Anterior Chamber Cannula, 27g</b> 27 gauge, 11mm from bend to tip. Overall length: 22mm.	
AXI4614	<b>Anterior Chamber Cannula, 27g</b> 27 gauge, 12mm from bend to tip. Overall length: 22mm.	
AXI4595	<b>Anterior Chamber Cannula, 30g</b> 30 gauge, 3mm from bend to tip. Overall length: 22mm.	
AXI21273	<b>Anterior Chamber Cannula, 30g</b> 30 gauge, 4mm from bend to tip. Overall length: 22mm.	
AXI21273-BULK	<b>Anterior Chamber Cannula, 30g</b> 30 gauge, 4mm from bend to tip. Overall length: 22mm. Sold 100 per bag.	
AXI4597	<b>Anterior Chamber Cannula, 30g</b> 30 gauge, 5mm from bend to tip. Overall length: 22mm.	
AXI21276	<b>Anterior Chamber Cannula, 30g</b> 30 gauge, 6mm from bend to tip. Overall length: 22mm.	
AXI1630	<b>Anterior Chamber Cannula, 30g</b> 30 gauge, 7mm from bend to tip. Overall length: 22mm.	
AXI21278	<b>Anterior Chamber Cannula, 30g</b> 30 gauge, 8mm from bend to tip. Overall length: 22mm.	
AXI4601	<b>Anterior Chamber Cannula, 30g</b> 30 gauge, 9mm from bend to tip. Overall length: 22mm.	
AXI4602	<b>Anterior Chamber Cannula, 30g</b> 30 gauge, 10mm from bend to tip. Overall length: 22mm.	
AXI4603	<b>Anterior Chamber Cannula, 30g</b> 30 gauge, 11mm from bend to tip. Overall length: 22mm.	
AXI4604	<b>Anterior Chamber Cannula, 30g</b> 30 gauge, 12mm from bend to tip. Overall length: 22mm.	

ACCUSURGICAL SINGLE-USE CANNULAS & CYSTOTOMES

Item #	Description	Image
--------	-------------	-------

**Anterior Chamber Cannula, Straight**

Our single-use Anterior Chamber Cannula, also known as Air Injection, Rycroft, and Viscoelastic cannula, is available from 19 to 30 gauge. Every cannula has a straight shaft with a blunt tip. Overall length ranges from 22mm to 32mm. Sold 10 per box.

AXI4678	<b>Anterior Chamber Cannula, 19g</b> 19 gauge. Overall length: 25mm.
AXI4676	<b>Anterior Chamber Cannula, 20g</b> 20 gauge. Overall length: 25mm.
AXI4674	<b>Anterior Chamber Cannula, 21g</b> 21 gauge. Overall length: 22mm.
AXI4671	<b>Anterior Chamber Cannula, 23g</b> 23 gauge. Overall length: 22mm.
AXI4672	<b>Anterior Chamber Cannula, 23g</b> 23 gauge. Overall length: 32mm.
AXI4669	<b>Anterior Chamber Cannula, 25g</b> 25 gauge. Overall length: 22mm.
AXI4667	<b>Anterior Chamber Cannula, 27g</b> 27 gauge. Overall length: 22mm.
AXI4665	<b>Anterior Chamber Cannula, 30g</b> 30 gauge. Overall length: 22mm.

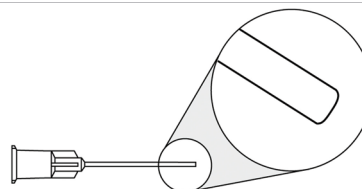

**Anterior Chamber Cannula, Curved**

Our single-use Anterior Chamber Cannula, also known as Air Injection, Rycroft, and Viscoelastic cannula, is available from 19 to 30 gauge. Every cannula has a curved shaft with a blunt tip. Overall length ranges from 22mm to 25mm. Sold 10 per box.

AXI4679	<b>Anterior Chamber Cannula, 19g</b> 19 gauge. Overall length: 25mm.
AXI4677	<b>Anterior Chamber Cannula, 20g</b> 20 gauge. Overall length: 25mm.
AXI4675	<b>Anterior Chamber Cannula, 21g</b> 21 gauge. Overall length: 22mm.
AXI4673	<b>Anterior Chamber Cannula, 23g</b> 23 gauge. Overall length: 22mm.
AXI4670	<b>Anterior Chamber Cannula, 25g</b> 25 gauge. Overall length: 22mm.
AXI4668	<b>Anterior Chamber Cannula, 27g</b> 27 gauge. Overall length: 22mm.
AXI4666	<b>Anterior Chamber Cannula 30g</b> 30 gauge. Overall length: 22mm.

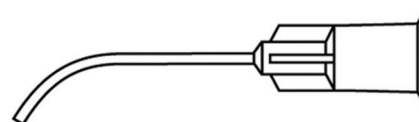



**ACCUSURGICAL SINGLE-USE CANNULAS & CYSTOTOMES**

Item #	Description	Image
--------	-------------	-------

**Air Injection Cannula**

26 gauge, angled shaft, 10mm from bend to tip, blunt tip. Disposable, sold 10 per box.

AXI21277 **Air Injection Cannula, 26g**

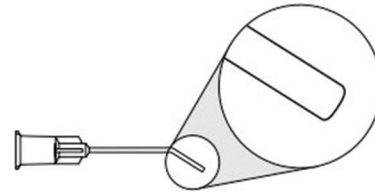

**Viscoelastic Cannula**

Disposable Viscoelastic Cannulas are 27 gauge with the option of an angled or formed shaft. They are 11mm from bend to tip and have blunt tips. Overall length: 22mm. Sold 10 per box.

AXI21279A **Angled Viscoelastic Cannula**  
Angled shaft.

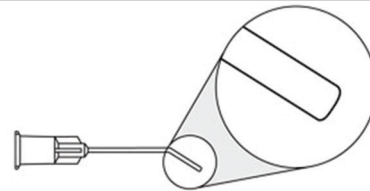

AXI4680 **Formed Viscoelastic Cannula**  
Formed shaft.

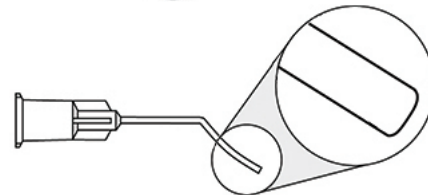

**Thin Wall Anterior Chamber Cannula, Angled**

A thin wall cannula allows the advantage of a larger bore through a smaller cannula. The inside diameter is approximately 2 gauge sizes larger, therefore, a 25 gauge thin wall lumen is approximately the same as the inside lumen on a 23 gauge. Thin Wall Anterior Chamber Cannulas are disposable and have angled shafts and blunt tips. Overall length: 22mm. Sold 10 per box.

AXI4691 **Thin Wall Cannula, 23g**  
23 gauge thin wall, 3mm from bend to tip.

AXI4692 **Thin Wall Cannula, 23g**  
23 gauge thin wall, 4mm from bend to tip.

AXI4693 **Thin Wall Cannula, 23g**  
23 gauge thin wall, 5mm from bend to tip.

AXI4694 **Thin Wall Cannula, 23g**  
23 gauge thin wall, 6mm from bend to tip.

AXI4695 **Thin Wall Cannula, 23g**  
23 gauge thin wall, 7mm from bend to tip.

AXI4696 **Thin Wall Cannula, 23g**  
23 gauge thin wall, 8mm from bend to tip.

AXI4697 **Thin Wall Cannula, 23g**  
23 gauge thin wall, 9mm from bend to tip.

AXI4698 **Thin Wall Cannula, 23g**  
23 gauge thin wall, 10mm from bend to tip.

AXI4699 **Thin Wall Cannula, 23g**  
23 gauge thin wall, 11mm from bend to tip.

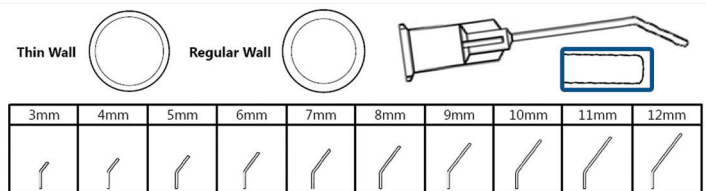

ACCUSURGICAL SINGLE-USE CANNULAS & CYSTOTOMES

Item #	Description	Image
AXI4700	<b>Thin Wall Cannula, 23g</b> 23 gauge thin wall, 12mm from bend to tip.	
AXI4681	<b>Thin Wall Cannula, 25g</b> 25 gauge thin wall, 3mm from bend to tip.	
AXI4682	<b>Thin Wall Cannula, 25g</b> 25 gauge thin wall, 4mm from bend to tip.	
AXI4683	<b>Thin Wall Cannula, 25g</b> 25 gauge thin wall, 5mm from bend to tip.	
AXI4684	<b>Thin Wall Cannula, 25g</b> 25 gauge thin wall, 6mm from bend to tip.	
AXI4685	<b>Thin Wall Cannula, 25g</b> 25 gauge thin wall, 7mm from bend to tip.	
AXI4686	<b>Thin Wall Cannula, 25g</b> 25 gauge thin wall, 8mm from bend to tip.	
AXI4687	<b>Thin Wall Cannula, 25g</b> 25 gauge thin wall, 9mm from bend to tip.	
AXI4688	<b>Thin Wall Cannula, 25g</b> 25 gauge thin wall, 10mm from bend to tip.	
AXI4689	<b>Thin Wall Cannula, 25g</b> 25 gauge thin wall, 11mm from bend to tip.	
AXI4690	<b>Thin Wall Cannula, 25g</b> 25 gauge thin wall, 12mm from bend to tip.	

**Thin Wall Anterior Chamber Cannula, Curved**

A thin wall cannula allows the advantage of a larger bore through a smaller cannula. The inside diameter is approximately 2 gauge sizes larger, therefore, a 25 gauge thin wall lumen is approximately the same as the inside lumen on a 23 gauge. Thin Wall Anterior Chamber Cannulas are disposable and have curved shafts and blunt tips. Overall length: 22mm. Sold 10 per box.

AXI4704	<b>Anterior Chamber Cannula, 23g</b> 23 gauge thin wall.
AXI4702	<b>Anterior Chamber Cannula, 25g</b> 25 gauge thin wall.

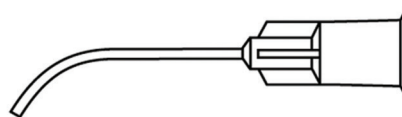

**Thin Wall Anterior Chamber Cannula, Straight**

A thin wall cannula allows the advantage of a larger bore through a smaller cannula. The inside diameter is approximately 2 gauge sizes larger, therefore, a 25 gauge thin wall lumen is approximately the same as the inside lumen on a 23 gauge. Thin Wall Anterior Chamber Cannulas are disposable and have straight shafts and blunt tips. Overall length: 22mm. Sold 10 per box.

AXI4703	<b>Anterior Chamber Cannula, 23g</b> 23 gauge thin wall.
AXI4701	<b>Anterior Chamber Cannula, 25g</b> 25 gauge thin wall.

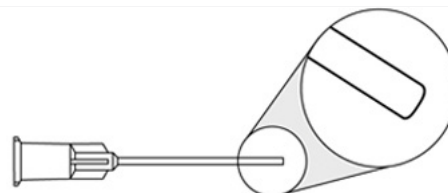

ACCUSURGICAL SINGLE-USE CANNULAS & CYSTOTOMES

Item #	Description	Image
--------	-------------	-------

**Double I/A Cannula**

Double Irrigating and Aspirating Cannulas are part of our disposable line. Each cannula has a straight shaft and are available in various gauges and tip types. Sold 10 per box.

AXI4705	<b>Double I/A Cannula Sideport</b> 21 gauge, one rounded closed 0.3mm sideport tip, one open tip.
---------	--

AXI4707	<b>Double I/A Cannula Open End</b> 21 gauge, both tips are open ended.
---------	---

AXI4708	<b>Double I/A Cannula Open End</b> 21 gauge, 19 gauge, both tips are open ended.
---------	---

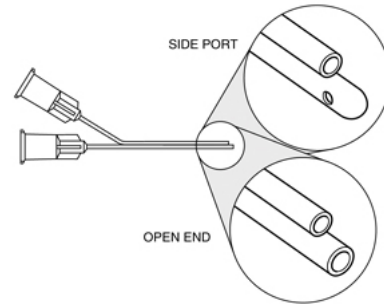

**J-Shaped Double I/A Cannula**

23 gauge and 25 gauge, straight shaft, open ended top tip, J-shaped bottom tip with 0.2mm sideport. Disposable, sold 10 per box.

AXI4706	<b>J-Shaped Double I/A Cannula</b>
---------	------------------------------------

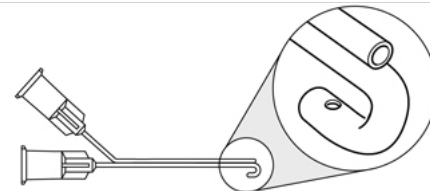

**Double Barrel I/A Cannula [Simcoe]**

Disposable Double Barrel Irrigating and Aspirating Cannulas are 23 gauge with curved shafts. They have rounded closed tips with 0.3mm sideport on the top or bottom and an open-ended slanted tip. Each cannula comes with 6" silicone tubing and measures 16mm in overall length. Sold 10 per box.

AXI4710	<b>Double Barrel I/A Cannula, Reverse</b> Sideport on bottom, open-ended slanted tip on top.
---------	---

AXI61571	<b>Double Barrel I/A Cannula, Standard</b> Sideport on top, open-ended slanted tip on bottom.
----------	--

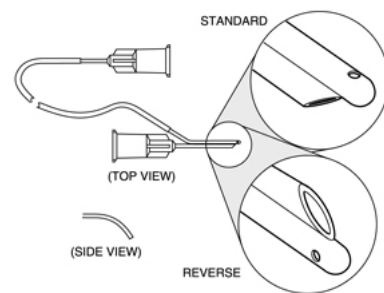

**Cortex Extractor [Charleux]**

23 gauge, curved shaft, open pointed tip. Overall length: 13mm. Disposable, sold 10 per box.

AXI4713	<b>Cortex Extractor, 23g</b>
---------	------------------------------

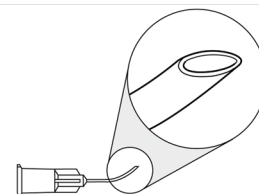

ACCUSURGICAL SINGLE-USE CANNULAS & CYSTOTOMES

Item #	Description	Image
--------	-------------	-------

**Cortex Extractor [Simcoe]**

Disposable Simcoe Cortex Extractor Cannulas are 23 gauge with curved shafts and rounded closed tips with 0.3mm sideport. Various lengths are available. Sold 10 per box.

AXI4711 **Cortex Extractor, 23g**  
Overall length: 13mm.

AXI55075 **Cortex Extractor, 23g**  
Overall length: 22mm.

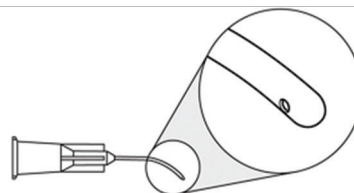

**Button Coaxial I/A System**

Disposable Button Coaxial Irrigating and Aspirating Systems have a 17 gauge thin wall outer cannula and a 21 gauge inner cannula. Straight shafts with closed, rounded tip and 0.3mm sideport. Overall length: 30mm. Sold 10 per box.

AXI4714 **Button Coaxial I/A System, Angled**  
30-degree angled tip.

AXI4715 **Button Coaxial I/A System, Straight**  
Straight tip.

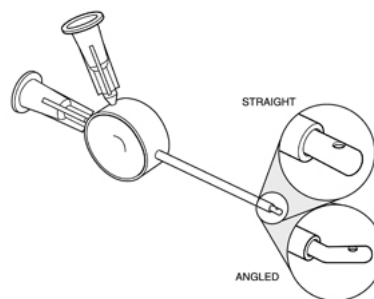

**J-Shaped Cannula**

Disposable J-shaped tip cannulas with both straight and angled shafts. Available in sizes from 21 gauge to 30 gauge and various sized tips. Overall length: 22mm. Sold 10 per box, unless specified otherwise.

AXI4725 **J-Shaped Cannula, 21g**  
21 gauge, straight shaft, 2mm high x 2mm wide tip.

AXI4723 **J-Shaped Cannula, 23g**  
23 gauge, straight shaft, 2mm high x 2mm wide tip.

AXI4724 **J-Shaped Cannula, 23g**  
23 gauge, 45 degree angled shaft, 10mm from bend to tip, 2mm high x 2mm wide tip.

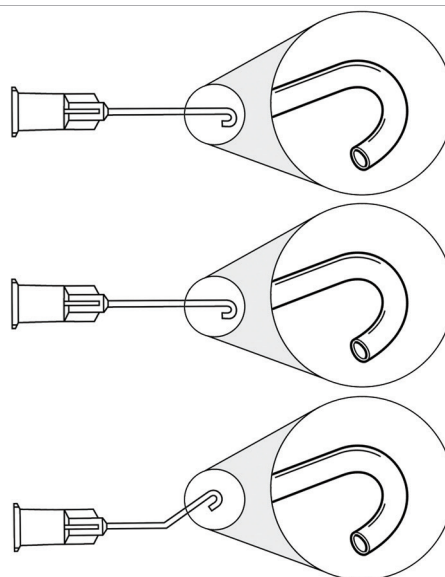

ACCUSURGICAL SINGLE-USE CANNULAS & CYSTOTOMES

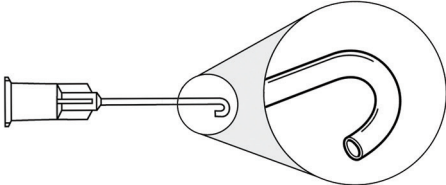
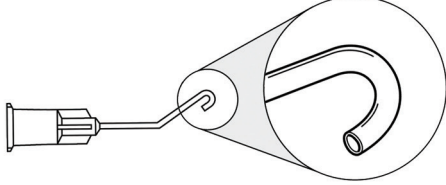
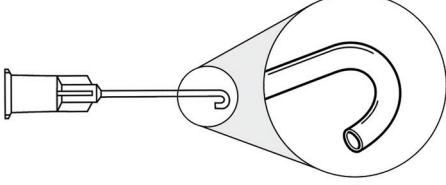
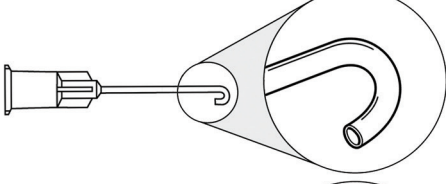
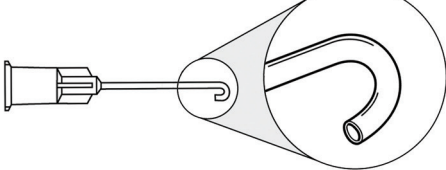
Item #	Description	Image
AXI0761	<b>J-Shaped Cannula, 25g</b> 25 gauge, straight shaft, 1.5mm high x 1.5mm wide tip.	
AXI4719	<b>J-Shaped Cannula, 25g</b> 25 gauge, 45 degree angled shaft, 10mm from bend to tip, 2mm high x 2mm wide tip.	
AXI51297	<b>J-Shaped Cannula, 27g</b> 27 gauge, straight shaft, 1.5mm high x 1.5mm wide tip.	
AXI51297-BULK	<b>J-Shaped Cannula, 27g</b> 27 gauge, straight shaft, 1.5mm high x 1.5mm wide tip. Sold 100 per bag.	
AXI51287	<b>J-Shaped Cannula, 30g</b> 30 gauge, straight shaft, 1.5mm high x 1.5mm wide tip.	

**J-Shaped Cannula [Binkhorst]**

The J-Shaped Binkhorst Cannula is available for left or right hand usage. Both choices are 25 gauge with 18 degree angled shaft, 12mm from bend to tip. A J-shaped tip that measures 1.5mm high x 1.75mm wide. Overall length: 22mm. Sold 10 per box.

AXI4720	<b>J-Shaped Cannula, 25g, Left</b> Angled left shaft.
AXI4721	<b>J-shaped Cannula, 25g, Right</b> Angled right shaft.

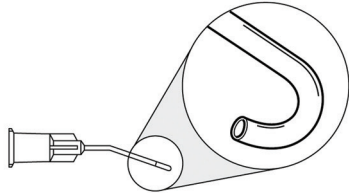

**Micro J-Shaped Cannula [Hessburg]**

25 gauge, straight shaft, J-shaped tip, 0.85mm long x 1.7mm wide. Overall length: 22mm. Disposable, sold 10 per box.

AXI4722	<b>Micro J-Shaped Cannula</b>
---------	-------------------------------

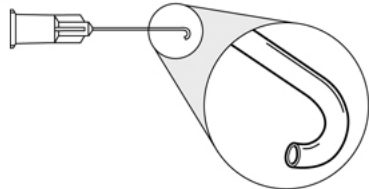

ACCUSURGICAL SINGLE-USE CANNULAS & CYSTOTOMES

Item #	Description	Image
<b>Irrigating Cystotome</b>		
Disposable Irrigating Cystotomes and Capsulorhexis Cystotomes with various shaft and tip styles. Each cystotome has a bent, pointed tip and is available in 23 to 30 gauge in size. Ranges in gauge and shaft styles. Overall length ranges from 16mm to 22mm. Sold 10 per box, unless specified otherwise.		
AXI31599	<b>Irrigating Cystotome, 23g</b> 23 gauge, formed shaft. Overall length: 16mm.	
AXI4731	<b>Irrigating Cystotome, 23g</b> 23 gauge, straight shaft. Overall length: 16mm.	
AXI4732	<b>Irrigating Cystotome, 23g</b> 23 gauge, straight shaft. Overall length: 19mm.	
AXI4739	<b>Irrigating Cystotome, 23g</b> 23 gauge, formed shaft. Overall length: 19mm.	
AXI4752	<b>Capsulorhexis Cystotome, 23g</b> 23 gauge, formed shaft with pointed tips that are twisted 90 degrees. Overall length: 16mm.	
AXI4753	<b>Capsulorhexis Cystotome, 23g</b> 23 gauge, straight shaft with pointed tips that are twisted 90 degrees. Overall length: 16mm.	
AXII348	<b>Irrigating Cystotome, 25g</b> 25 gauge, formed shaft. Overall length: 16mm.	
AXII891	<b>Irrigating Cystotome, 25g</b> 25 gauge, formed shaft, reverse formed, tip angled 90 degrees toward bevel. Overall length: 16mm.	

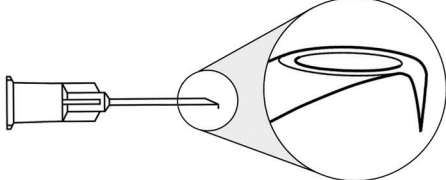
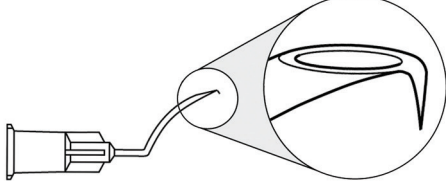
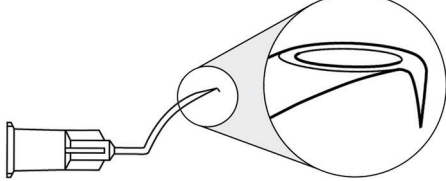
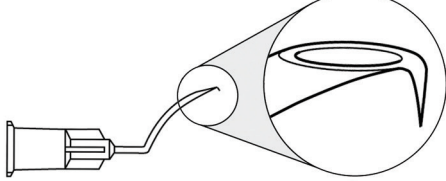
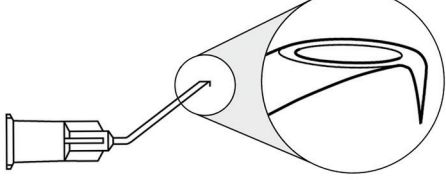
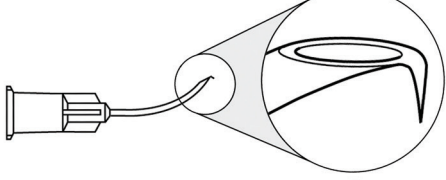
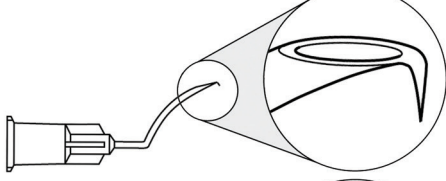
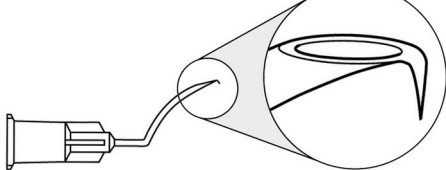

ACCUSURGICAL SINGLE-USE CANNULAS & CYSTOTOMES

Item #	Description	Image
AXI31610A	<p><b>Irrigating Cystotome, 25g</b>                      25 gauge, straight shaft. Overall length: 16mm.</p>	
AXI31610	<p><b>Irrigating Cystotome, 25g</b>                      25 gauge, formed shaft. Overall length: 16mm.</p>	
AXI31610-BULK	<p><b>Irrigating Cystotome, 25g</b>                      25 gauge, formed shaft. Overall length: 16mm. Sold 100 per bog.</p>	
AXI35004	<p><b>Irrigating Cystotome, 25g</b>                      25 gauge, formed shaft, small radius tip. Overall length: 16mm.</p>	
AXI35049	<p><b>Irrigating Cystotome, 25g</b>                      25 gauge, angled shaft. Overall length: 16mm.</p>	
AXI4743	<p><b>Irrigating Cystotome [Joyce], 25g</b>                      25 gauge, curved shaft. Overall length: 16mm.</p>	
AXI4736	<p><b>Irrigating Cystotome, 25g</b>                      25 gauge, formed shaft. Overall length: 16mm.</p>	
AXI4737	<p><b>Irrigating Cystotome, 25g</b>                      25 gauge, formed shaft. Overall length: 22mm.</p>	

ACCUSURGICAL SINGLE-USE CANNULAS & CYSTOTOMES

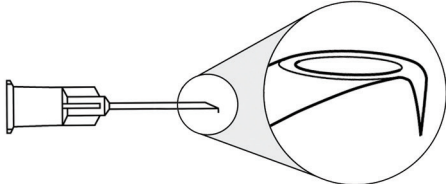
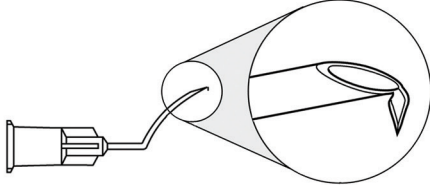
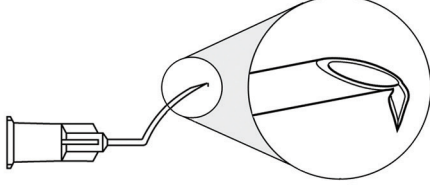
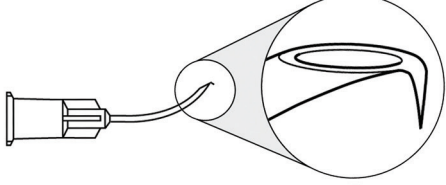
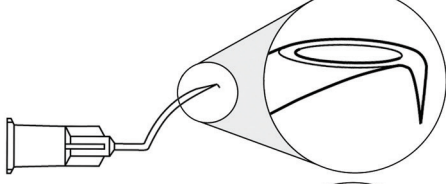
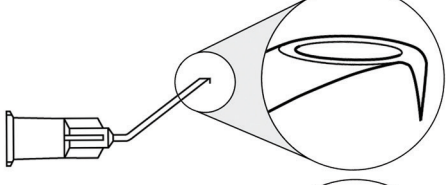
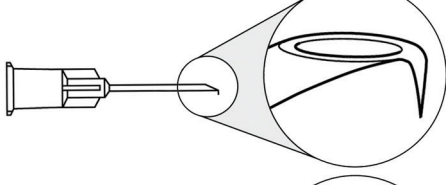
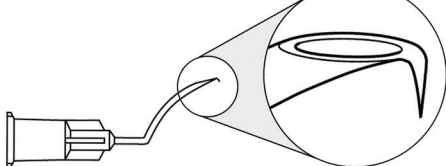
Item #	Description	Image
AXI4730	<p><b>Irrigating Cystotome, 25g</b>                      25 gauge, straight shaft. Overall length: 22mm.</p>	 <p>A technical drawing of a straight shaft cystotome. It features a cylindrical handle with a knurled grip and a long, thin, straight shaft that terminates in a curved, hook-like tip. A circular inset provides a magnified view of the tip's curvature.</p>
AXI35113	<p><b>Capsulorhexis Cystotome, 25g</b>                      25 gauge, formed shaft with pointed tips that are twisted 90 degrees. Overall length: 16mm.</p>	 <p>A technical drawing of a cystotome with a curved shaft. The shaft is formed with a hook-like tip. A circular inset shows a magnified view of the tip, which has two sharp, pointed ends twisted 90 degrees relative to each other.</p>
AXI4751	<p><b>Capsulorhexis Cystotome, 25g</b>                      25 gauge, straight shaft with pointed tips that are twisted 90 degrees. Overall length: 16mm.</p>	 <p>A technical drawing of a cystotome with a curved shaft, similar to AXI35113. It features a hook-like tip with two sharp, pointed ends twisted 90 degrees. A circular inset shows a magnified view of the tip.</p>
AXI4742	<p><b>Irrigating Cystotome [Joyce], 27g</b>                      27 gauge, curved shaft. Overall length: 16mm.</p>	 <p>A technical drawing of a cystotome with a curved shaft. The shaft is formed with a hook-like tip. A circular inset shows a magnified view of the tip, which has two sharp, pointed ends twisted 90 degrees.</p>
AXI31618	<p><b>Irrigating Cystotome, 27g</b>                      27 gauge, formed shaft. Overall length: 16mm.</p>	 <p>A technical drawing of a cystotome with a curved shaft, similar to AXI35113. It features a hook-like tip with two sharp, pointed ends twisted 90 degrees. A circular inset shows a magnified view of the tip.</p>
AXI35093	<p><b>Irrigating Cystotome, 27g</b>                      27 gauge, angled shaft. Overall length: 16mm.</p>	 <p>A technical drawing of a cystotome with a curved shaft, similar to AXI35113. It features a hook-like tip with two sharp, pointed ends twisted 90 degrees. A circular inset shows a magnified view of the tip.</p>
AXI4727	<p><b>Irrigating Cystotome, 27g</b>                      27 gauge, straight shaft. Overall length: 16mm.</p>	 <p>A technical drawing of a straight shaft cystotome, similar to AXI4730. It features a cylindrical handle with a knurled grip and a long, thin, straight shaft that terminates in a curved, hook-like tip. A circular inset provides a magnified view of the tip's curvature.</p>
AXI4745	<p><b>Irrigating Cystotome, 27g</b>                      27 gauge, formed shaft, small radius tip. Overall length: 16mm.</p>	 <p>A technical drawing of a cystotome with a curved shaft, similar to AXI35113. It features a hook-like tip with two sharp, pointed ends twisted 90 degrees. A circular inset shows a magnified view of the tip.</p>

ACCUSURGICAL SINGLE-USE CANNULAS & CYSTOTOMES

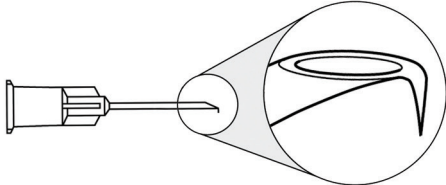
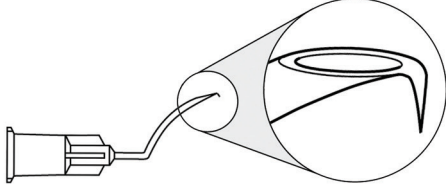
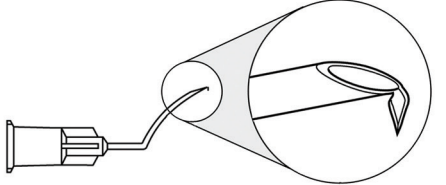
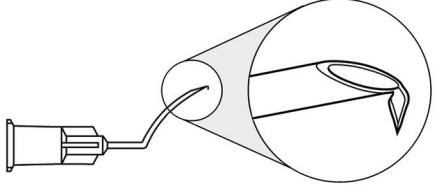
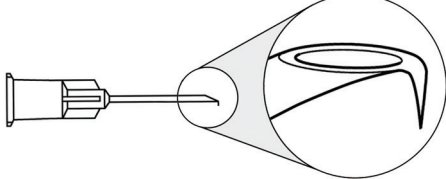
Item #	Description	Image
AXI4728	<b>Irrigating Cystotome, 27g</b> 27 gauge, straight shaft. Overall length: 19mm.	
AXI4735	<b>Irrigating Cystotome, 27g</b> 27 gauge, formed shaft. Overall length: 19mm.	
AXI35042	<b>Capsulorhexis Cystotome, 27g</b> 27 gauge, formed shaft with pointed tips that are twisted 90 degrees. Overall length: 16mm.	
AXI4749	<b>Capsulorhexis Cystotome, 27g</b> 27 gauge, straight shaft with pointed tips that are twisted 90 degrees. Overall length: 16mm.	
AXI4726	<b>Irrigating Cystotome, 30g</b> 30 gauge, straight shaft. Overall length: 16mm.	

**Irrigating Double Sharp Cystotome [Kelman]**

22 gauge, straight shaft, bent, pointed tip. Overall length: 25mm. Disposable, sold 10 per box.

AXI4755	<b>Irrigating Double Sharp Cystotome, 22g</b>	
---------	---	--

ACCUSURGICAL SINGLE-USE CANNULAS & CYSTOTOMES

Item #	Description	Image
--------	-------------	-------

**Irrigating Sharp Cystotome [Kelman]**

22 gauge, straight shaft, bent, pointed tip. Overall length: 25mm. Disposable, sold 10 per box.

AXI4754 **Irrigating Sharp Cystotome, 22g**

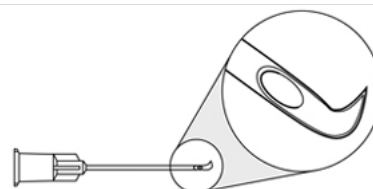

**Capsule Polisher**

Single-use Capsule Polisher cannula available in 21 gauge or 23 gauge sizes with a 37 degree angled shaft. Angled shaft is 7mm from bend to tip and has various types of 3mm sandblasted tips. Overall length: 22mm. Sold 10 per box.

AXI4756 **Capsule Polisher, 21g**  
21 gauge, 3mm sandblasted closed distal tip with 0.3mm sideport.

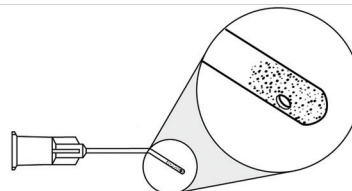

AXI4758 **Capsule Polisher, 21g**  
21 gauge, 3mm sandblasted distal end tip, open ended.

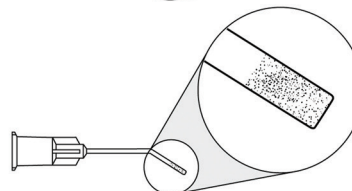

AXI4757 **Capsule Polisher, 23g**  
23 gauge, 3mm sandblasted closed distal tip with 0.3mm sideport.

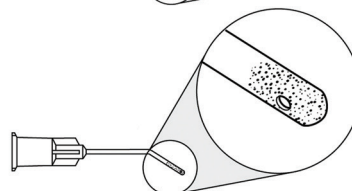

AXI4759 **Capsule Polisher, 23g**  
23 gauge, 3mm sandblasted distal end tip, open ended.

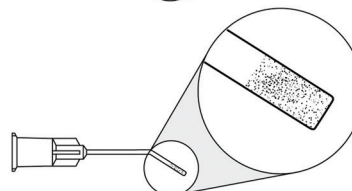

**Posterior Capsule Polisher**

23 gauge, 45-degree angled shaft, 12mm from bend to tip, 2mm sandblasted distal end, angled 90 degrees. Overall length: 22mm. Disposable, sold 10 per box.

AXI4760 **Posterior Capsule Polisher, 23g**

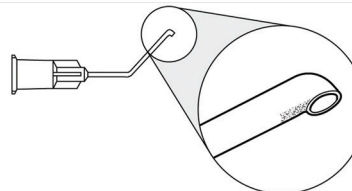

ACCUSURGICAL SINGLE-USE CANNULAS & CYSTOTOMES

Item #	Description	Image
--------	-------------	-------

**Silicone Tip Capsule Polisher**

Disposable Silicone Tip Capsule Polisher cannula with 32-degree angled shafts. Cannulas come with various lengths of squeegee, silicone tubing. Overall length: 22mm. Sold 10 per box.

AXI75041	<b>Capsule Polisher, 23g</b> 23 gauge, 7mm from bend to tip, 10mm silicone tubing.
AXI4763	<b>Capsule Polisher, 23g</b> 23 gauge, 9mm from bend to tip, 12mm silicone tubing.
AXI75005	<b>Capsule Polisher, 27g</b> 27 gauge, 7mm from bend to tip, 10mm silicone tubing.

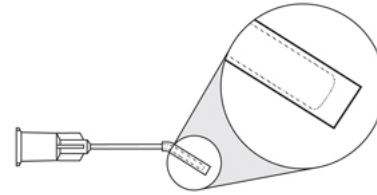

**Irrigating Vectis**

24 gauge Irrigating Vectis cannula is part of the AccuSurgical Single Use line. Each cannula has a straight shaft with a curved looped tip and one to three ports. Tips are available in 3mm to 5mm widths. Sold 10 per box.

AXI4765	<b>Irrigating Vectis, 3mm</b> Curved 3mm loop tip, one 0.3mm port.
AXI4766	<b>Irrigating Vectis, 4mm</b> Curved 4mm loop tip, two 0.3mm ports.
AXI4767	<b>Irrigating Vectis, 5mm</b> Curved 5mm loop tip, three 0.3mm ports.
AXI4764	<b>Irrigating Vectis, 5mm</b> Curved 5mm loop tip, one 0.3mm port.

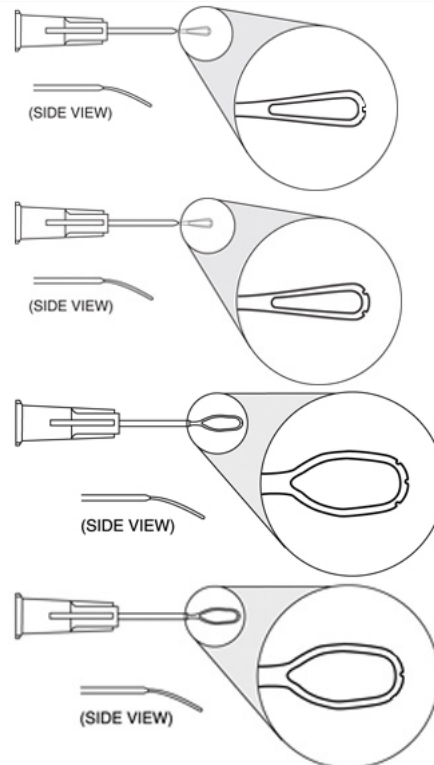

**Bishop-Harmon Washout Cannula**

Disposable 19 gauge Bishop-Harmon Washout Cannulas with 37-degree angled shafts and smooth oval shaped tips. Overall length: 25mm. Sold 10 per box unless specified otherwise.

AXI65041	<b>Washout Cannula, 19g</b> 19 gauge, 37-degree angled shaft, 5mm from bend to tip.
AXI65040	<b>Washout Cannula, 19g</b> 19 gauge, 37-degree angled shaft, 8mm from bend to tip.
AXI65040-BULK	<b>Washout Cannula, 19g</b> 19 gauge, 37-degree angled shaft, 8mm from bend to tip. Sold 100 per bag.

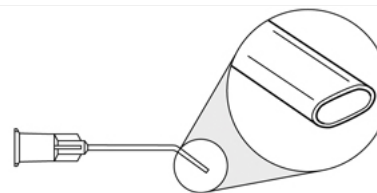

## ACCUSURGICAL SINGLE-USE CANNULAS &amp; CYSTOTOMES

Item #	Description	Image
--------	-------------	-------

**Nucleus Hydrodissection Cannula**

Disposable Nucleus Hydrodissection Cannula with 32-degree angled shaft, 8mm from bend to tip. Cannulas are available in 23 gauge to 30 gauge sizes with flattened, smooth, oval-shaped tip. Overall length: 22mm. Sold 10 per box, unless specified otherwise.

AXI4772	<b>Nucleus Hydrodissection Cannula, 23g</b>	
---------	---	--

23 gauge.

AXI25037	<b>Nucleus Hydrodissection Cannula, 25g</b>
----------	---

25 gauge.

AXI25037-BULK	<b>Nucleus Hydrodissection Cannula, 25g</b>
---------------	---

25 gauge. Sold 100 per bag.

AXI25158	<b>Nucleus Hydrodissection Cannula, 27g</b>
----------	---

27 gauge.

AXI3014	<b>Nucleus Hydrodissection Cannula, 30g</b>
---------	---

30 gauge.

**Hydrodissection Cannula [Chang]**

27 gauge, straight shaft, flattened tip. Overall length: 22mm. Disposable, sold 10 per box.

AXI4784	<b>Hydrodissection Cannula</b>	
---------	--------------------------------	---

**Hydrodissection Cannula [Kellan]**

Kellan Hydrodissection Cannulas are part of the AccuSurgical Single Use product line. These cannulas are available in 25 gauge or 27 gauge with curved shafts and blunt, oval-shaped tips. Overall length: 22mm. Sold 10 per box.

AXI4778	<b>Hydrodissection Cannula, 25g</b>	
---------	-------------------------------------	--

25 gauge.

AXI21273D	<b>Hydrodissection Cannula, 27g</b>
-----------	-------------------------------------

27 gauge.



ACCUSURGICAL SINGLE-USE CANNULAS & CYSTOTOMES

Item #	Description	Image
--------	-------------	-------

**J-Shaped Hydrodissection Cannula**

Disposable J-Shaped Hydrodissection Cannulas range in size from 25 gauge to 30 gauge. Each cannula has a straight shaft with a smooth oval and J-shaped tip that is available in different widths. Overall length: 22mm. Sold 10 per box.

AXI4775	<b>J-Shaped Hydrodissection Cannula, 25g</b> 25 gauge, 1.5mm high x 2mm wide tip.
AXI25029	<b>J-Shaped Hydrodissection Cannula, 27g</b> 27 gauge, 1.5mm high x 1.75mm wide tip.
AXI4773	<b>J-Shaped Hydrodissection Cannula, 30g</b> 30 gauge, 1.5mm high x 1.5mm wide tip.

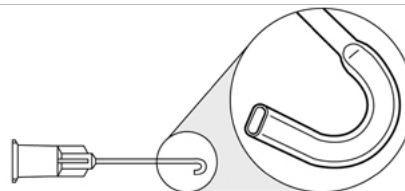

**Hydrodelineation Needle [Kellan]**

Disposable Kellan Hydrodelineation Needles are available in 25 gauge or 27 gauge sizes. Each one has a curved shaft with a shortened bevel, needle tip. Overall length: 22mm. Sold 10 per box.

AXI4776	<b>Hydrodelineation Needle, 25g</b> 25 gauge.
AXI4777	<b>Hydrodelineation Needle, 27g</b> 27 gauge.

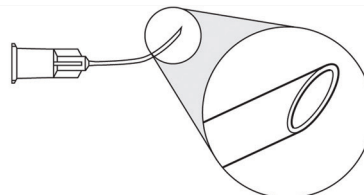

**Nucleus Hydrolysis Needle [P. Koch]**

25 gauge, curved shaft, flattened, oval-shaped tip. Overall length: 22mm. Disposable, sold 10 per box.

AXI4780	<b>Nucleus Hydrolysis Needle, 25g</b>
---------	---------------------------------------

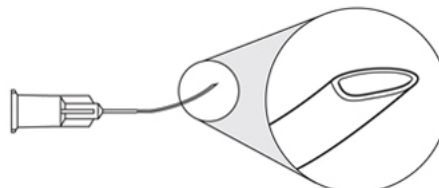

**Nucleus Hydrodissector/Rotator [Sinskey]**

25 gauge, 32-degree angled shaft, 8mm from bend to tip, forked blunt tip. Overall length: 22mm. Disposable, sold 10 per box.

AXI4781	<b>Nucleus Hydrodissector/Rotator</b>
---------	---------------------------------------

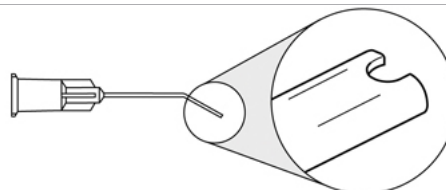

**Cotrical Cleaving Hydrodissector**

27 gauge, angled shaft, 11mm from bend to tip, horizontally flattened tip, flattened 4mm from tip. Overall length: 22mm. Disposable, sold 10 per box.

AXI25157	<b>Cotrical Cleaving Hydrodissector, 27g</b>
----------	--

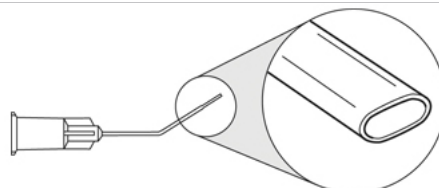

ACCUSURGICAL SINGLE-USE CANNULAS & CYSTOTOMES

Item #	Description	Image
--------	-------------	-------

**Nucleus Hydrodissector**

27 gauge, curved shaft, tip flattened horizontally 4mm from end. Overall length: 22mm. Disposable, sold 10 per box.

AXI25155      **Nucleus Hydrodissector, 27g**

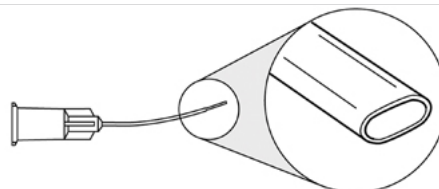

**Lacrimal Cannula**

Disposable Lacrimal Cannulas are available with either straight or curved shafts. Sizes range from 19 gauge to 26 gauge. Sold 10 per box.

AXI4786      **Lacrimal Cannula Straight, 19g**  
 19 gauge tapered to 23 gauge, straight shaft, tapered 12mm from tip. Overall length: 38mm.

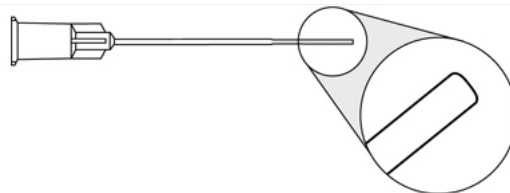

AXI4785      **Lacrimal Cannula Curved, 25g**  
 25 gauge, slightly curved shaft, tumble polished edge. Overall length: 28mm.

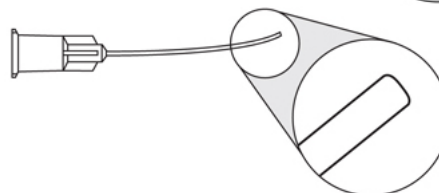

AXI0649      **Lacrimal Cannula Curved, 26g**  
 26 gauge, curved shaft, open tip. Overall length: 28mm.

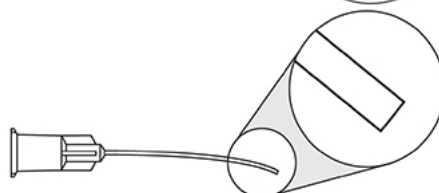

**Irrigating Dialer**

30 gauge, 45-degree angled shaft, 10mm from bend to tip, 1mm distal end angled 65 degrees. Overall length: 22mm. Disposable, sold 10 per box.

AXI4802      **Irrigating Dialer**

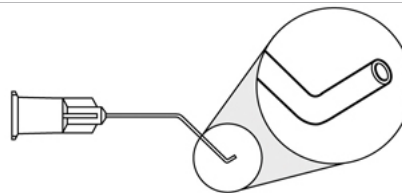

**Alpha-Chymotrypsin Cannula**

25 gauge, curved shaft, 1mm smooth, bulbous tip. Overall length: 28mm. Disposable, sold 10 per box.

AXI4808      **Alpha-Chymotrypsin Cannula**

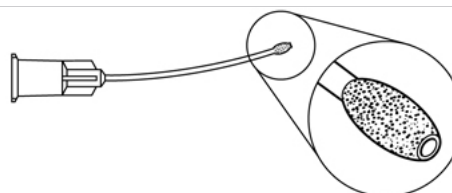

ACCUSURGICAL SINGLE-USE CANNULAS & CYSTOTOMES

Item #	Description	Image
--------	-------------	-------

**Olive Tip Capsule Polisher**

Disposable Olive Tip Cannulas range from 23 gauge to 25 gauge in size and are available with angled or curved shafts. Each cannula has a 1mm sandblasted or smooth bulbous tip. Sold 10 per box.

AXI4810 **Olive Tip Capsule Polisher, 23g**  
23 gauge, curved shaft. Smooth tip. Overall length: 22mm.

AXI4812 **Olive Tip Capsule Polisher, 23g**  
23 gauge, angled shaft, 10mm from bend to tip. Sandblasted tip. Overall length: 22mm.

AXI4811 **Olive Tip Capsule Polisher, 23g**  
23 gauge, curved shaft. Sandblasted tip. Overall length: 22mm.

AXI4809 **Olive Tip Capsule Polisher, 25g**  
25 gauge, curved shaft. Sandblasted tip. Overall length: 28mm.

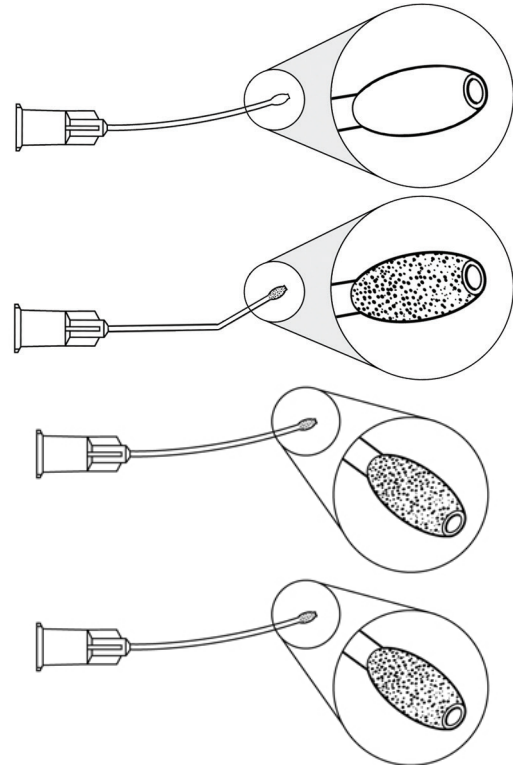

**Chamber Maintainer**

Disposable Chamber Maintainer cannulas range from 20 gauge to 27 gauge in size. Each cannula has a straight shaft with a sharp, closed end tip with a 0.2mm or 0.3mm sideport. Comes with 6" silicone tubing and has an overall length of 22mm. Sold 10 per box.

AXI4820 **Chamber Maintainer, 20g**  
20 gauge, 0.3mm sideport, 6" silicone tubing: ID - 0.75mm (0.030"), OD - 1.65mm (0.065").

AXI4819 **Chamber Maintainer, 23g**  
23 gauge, 0.3mm sideport, 6" silicone tubing: ID - 0.5mm (0.020"), OD - 0.95mm (0.037").

AXI4818 **Chamber Maintainer, 25g**  
25 gauge, 0.2mm sideport, 6" silicone tubing: ID - 0.3mm (0.012"), OD - 0.6mm (0.025").

AXI4817 **Chamber Maintainer, 27g**  
27 gauge, 0.2mm sideport, 6" silicone tubing: ID - 0.3mm (0.012"), OD - 0.6mm (0.025").

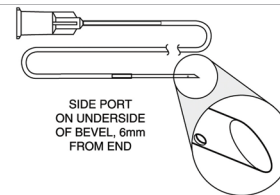

ACCUSURGICAL SINGLE-USE CANNULAS & CYSTOTOMES

Item #	Description	Image
--------	-------------	-------

**Chamber Maintainer with Serrated Tip**

Disposable Chamber Maintainer cannulas range from 23 gauge to 25 gauge in size. Each cannula has a straight shaft with a 4mm serrated, pointed tip with 6" silicone tubing. Overall length: 22mm. Sold 10 per box.

AXI4822	<b>Chamber Maintainer, 23g</b> 23 gauge, 6" silicone tubing: ID - 0.5mm (0.020"), OD - 0.95mm (0.037").
---------	--

AXI4821	<b>Chamber Maintainer, 25g</b> 25 gauge, 6" silicone tubing: ID - 0.3mm (0.012"), OD - 0.6mm (0.025").
---------	---

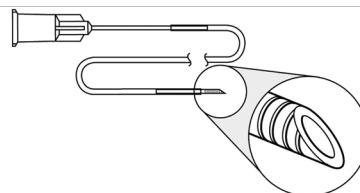

**Infusion Cannula**

Disposable Infusion Cannulas are available in 20 gauge size with straight shafts and 2.5mm to 6mm wide tips. Comes with 6" silicone tubing. Sold 10 per box.

AXI4824	<b>Infusion Cannula, 2.5mm</b> 2.5mm tip, 6" silicone tubing: ID - 0.75mm (0.030"), OD - 1.65 (0.065").
---------	--

AXI4825	<b>Infusion Cannula, 4mm</b> 4mm tip, 6" silicone tubing: ID - 0.75mm (0.030"), OD - 1.65 (0.065").
---------	--

AXI4826	<b>Infusion Cannula, 6mm</b> 6mm tip, 6" silicone tubing: ID - 0.75mm (0.030"), OD - 1.65 (0.065").
---------	--

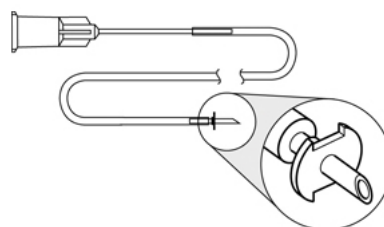

**Membrane Micropick [Eaton]**

20 gauge, straight shaft, tapered to 30 gauge x 5mm distal end, 0.5mm sharp tip, angled 50 degrees toward bevel. Overall length: 25mm. Disposable, sold 10 per box.

AXI4843	<b>Membrane Micropick, 20g</b>
---------	--------------------------------

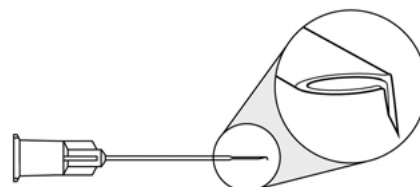

**Retinal Backflush Cannula**

Retinal Backflush Cannulas are 23 gauge and have either brush or charles flute tips. Straight shaft. Disposable. Sold 5 per box.

AXI5635	<b>Brush Tip Cannula, 23g</b> 0.9mm silicone brush tip.
---------	--

AXI5636	<b>Charles Flute Cannula, 23g</b> Blunt tip.
---------	---

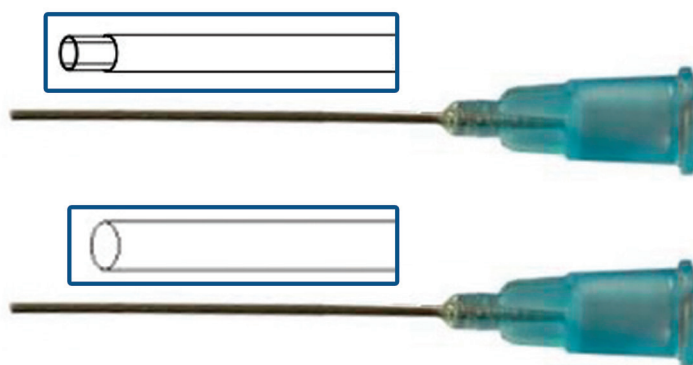

ACCUSURGICAL SINGLE-USE CANNULAS & CYSTOTOMES

Item #	Description	Image
<b>Extrusion Cannula</b>		
Disposable Extrusion Cannulas are available in 19 gauge to 23 gauge sizes with a straight shaft. Comes with a tumble polished edge tip and an overall length of 22mm or 25mm. Sold 10 per box.		
AXI4835	<p><b>Extrusion Cannula, 19g</b></p> <p>19 gauge, tapered tip, tapered to 23 gauge, 4mm from end, 1mm distal end, angled 45 degrees. Overall length: 25mm.</p>	
AXI4832	<p><b>Extrusion Cannula, 19g</b></p> <p>19 gauge, blunt tip. Overall length: 25mm.</p>	
AXI4833	<p><b>Extrusion Cannula, 19g</b></p> <p>19 gauge, tapered tip, tapered to 23 gauge, 4mm from end. Overall length: 25mm.</p>	
AXI4827	<p><b>Extrusion Cannula, 20g</b></p> <p>20 gauge, blunt tip. Overall length: 25mm.</p>	
AXI4828	<p><b>Extrusion Cannula, 20g</b></p> <p>20 gauge, tapered tip, tapered to 25 gauge, 4mm from end. Overall length: 25mm.</p>	
AXI4830	<p><b>Extrusion Cannula, 20g</b></p> <p>20 gauge, tapered tip, tapered to 25 gauge, 4mm from end, 1mm distal end, angled 45 degrees. Overall length: 25mm.</p>	
AXI4837	<p><b>Extrusion Cannula, 23g</b></p> <p>23 gauge, blunt tip, tumble polished edge. Overall length: 22mm.</p>	

ACCUSURGICAL SINGLE-USE CANNULAS & CYSTOTOMES

Item #	Description	Image
<b>Extrusion Cannula with Silicone Tubing</b>		
Disposable Extrusion Cannulas are available in 19 gauge or 20 gauge sizes with a straight or angled shaft. Has a tapered tip with tubing that bends 4mm from end. Overall length of 25mm. Sold 10 per box.		
AXI4834	<b>Extrusion Cannula, Straight</b> 19 gauge, tapered to 23 gauge, straight shaft.	
AXI4836	<b>Extrusion Cannula, Angled</b> 19 gauge, tapered to 23 gauge, angled shaft.	
AXI4829	<b>Extrusion Cannula, Straight</b> 20 gauge, tapered to 25 gauge, straight shaft.	
AXI4831	<b>Extrusion Cannula, Angled</b> 20 gauge, tapered to 25 gauge, angled shaft.	

**High Viscosity Fluid Cannula [Peyman]**

16 gauge, curved shaft, pointed tip. Overall length: 9mm. Disposable, sold 10 per box.

AXI4838	<b>High Viscosity Fluid Cannula, 16g</b>
---------	--

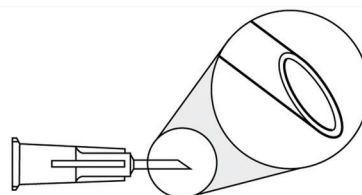

**Membrane Dissector [Kingham]**

20 gauge, straight shaft, 0.5mm sharp tip, angled 45 degrees toward bevel. Overall length: 25mm. Disposable, sold 10 per box.

AXI4839	<b>Membrane Dissector, 20g</b>
---------	--------------------------------

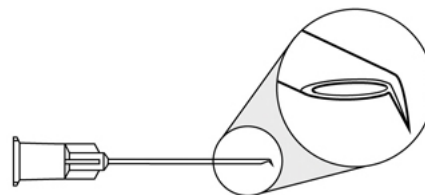

**Subretinal Injector [Lambert]**

20 gauge, straight shaft, curved, tapered tip, tapered to 33 gauge x 7mm, distal end. Overall length: 25mm. Disposable, sold 10 per box.

AXI4840	<b>Subretinal Injector</b>
---------	----------------------------

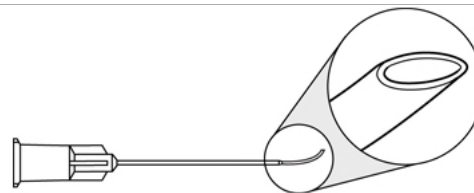

**Subretinal Aspirator [Landers]**

20 gauge, straight shaft, tapered, angled tip, 2.5mm from bend to tip, tapered to 27 gauge x 6mm. Overall length: 25mm. Disposable, sold 10 per box.

AXI4841	<b>Subretinal Aspirator</b>
---------	-----------------------------

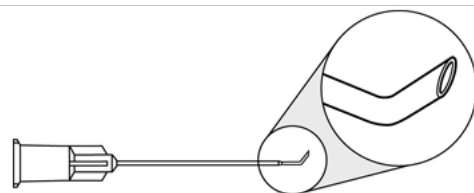



**ACCUSURGICAL SINGLE-USE CANNULAS & CYSTOTOMES**

Item #	Description	Image
--------	-------------	-------

**Vitreoretinal Micropick [Glaser]**

Disposable Glaser Vitreoretinal Micropick cannulas are available in either 20 gauge or 23 gauge with straight tapered shafts. Sharp tips measure 0.5mm in width and are angled 50 degrees toward the bevel. Overall length: 25mm. Sold 10 per box.

AXI4844 **Vitreoretinal Micropick, 20g**  
20 gauge, tapered to 25 gauge x 3/16" distal end.

AXI4845 **Vitreoretinal Micropick, 23g**  
23 gauge, tapered to 27 gauge x 3/16" distal end.

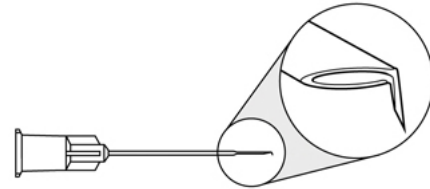

**Vitreoretinal Cannula [Vander]**

Disposable Vitreoretinal Cannulas are 20 gauge in size with straight shafts that are tapered to 30 gauge. Sold 10 per box.

AXI4846 **Straight Vitreoretinal Cannula**  
Straight tapered tip.

AXI4847 **Angled Vitreoretinal Cannula**  
Angled tapered tip.

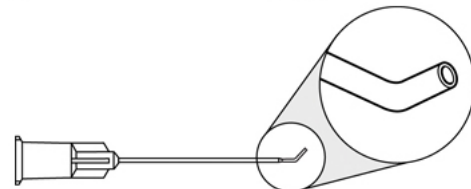
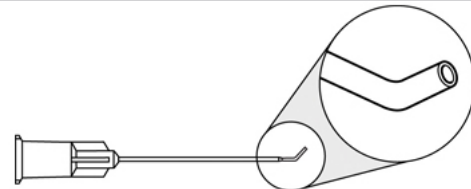

**Subretinal Injector [Glaser]**

Disposable Glaser Subretinal Injector cannulas come in 20 gauge with a curved or straight shaft. Has a tapered to 33 gauge tip and 3mm distal end. Overall length: 25mm. Sold 10 per box.

AXI4848 **Curved Subretinal Injector**  
Curved shaft.

AXI4849 **Straight Subretinal Injector**  
Straight shaft.

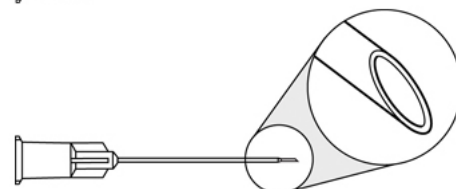
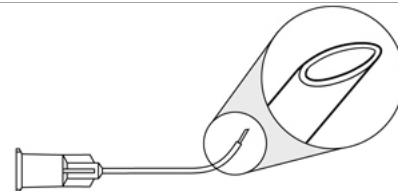

**MVR Cannula [Glaser]**

20 gauge, angled shaft, 1mm from bend to tip, tapered tip 33 gauge x 4mm, distal end. Overall length: 25mm. Disposable, sold 10 per box.

AXI4850 **MVR Cannula, 20g**

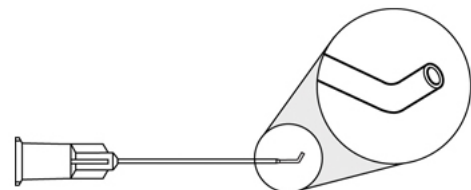

ACCUSURGICAL SINGLE-USE CANNULAS & CYSTOTOMES

Item #	Description	Image
--------	-------------	-------

**Subretinal Cannula [Lambert]**

20 gauge, straight shaft, curved distal end, tapered to 33 gauge x 7mm. Overall length: 25mm. Disposable, sold 10 per box.

AXI4851      [Subretinal Cannula](#)

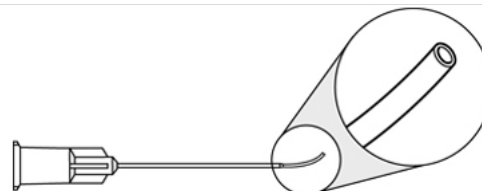

**LASIK Cannula [Dishler]**

27 gauge, formed shaft, 9mm from bend to tip, rounded closed tip with 4 sideports. Overall length: 16mm. Disposable, sold 10 per box.

AXI4852      [LASIK Cannula, 27g](#)

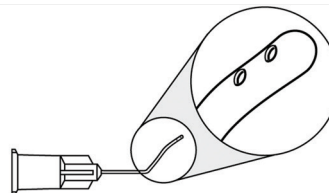

**LASIK Cannula [Slade]**

26 gauge, formed shaft, 9mm from bend to tip, slanted tip. Overall length: 22mm. Disposable, sold 10 per box.

AXI4853      [LASIK Cannula, 26g](#)

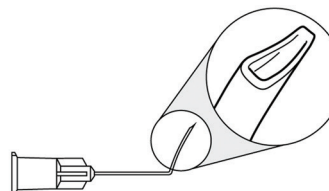

**LASIK Cannula [Linn]**

25 gauge, angled shafts, 9mm from bend to tip, flat bend, 2 ports, open end. Disposable, sold 10 per box.

AXI4855      [LASIK Cannula, 25g](#)

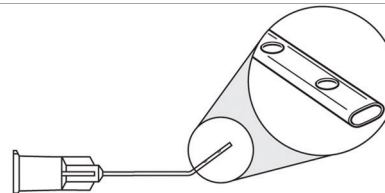

**Refractive Cannula**

25 gauge, angled shaft, dual shafts, 8 ports, closed tip. Disposable, sold 10 per box.

AX205256      [Refractive Cannula, 25g](#)

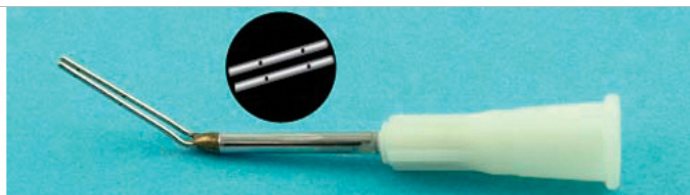

ACCUSURGICAL SINGLE-USE CANNULAS & CYSTOTOMES

Item #	Description	Image
--------	-------------	-------

**Femtosecond Cannula [Solomon]**

30 gauge hydrodissector, angled shaft, 7mm from bend to tip, sandblasted, oval-shaped tip. Disposable, sold 10 per box.

AXI5227 [Femtosecond Cannula](#)

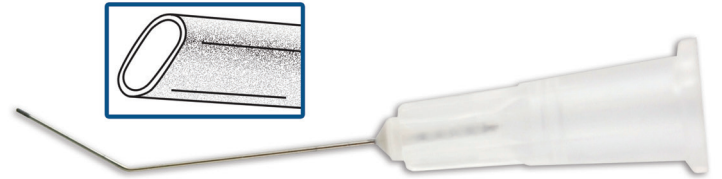

**Brody Femtosecond Dissecting Cannula**

The Brody Femtosecond Dissecting Cannula for laser-assisted cataract surgery is a disposable 25 gauge stainless steel cannula that both easily opens laser incisions and allows for fast, efficient injection of intraocular lidocaine and/or viscoelastic. This elegant device is placed either on a TB syringe filled with lidocaine or directly on the viscoelastic syringe (for those not using intraocular anesthetic). The shovel-like tip allows for easy and safe opening of both the sideport and the main incision. Single-use design removes the need for sterilization. Combination of spatula and cannula reduces the number of instrument hand-offs between scrub tech and surgeon, saving time and improving efficiency. Unique tip design with 25 gauge width reduces wound stretching when compared to other laser incision instrumentation.

AX20001 [Femtosecond Dissecting Cannula](#)

Sold 10 per box.

AX20001-BULK [Femtosecond Dissecting Cannula](#)

Sold 100 per bag.

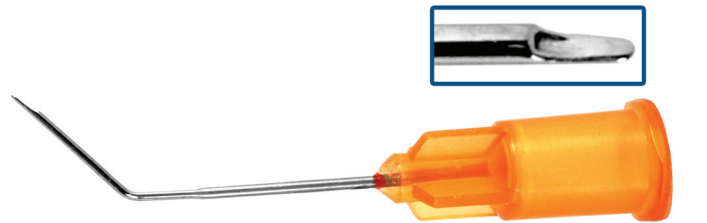

**AccuDrop Cannula**

AccuDrop is Accutome's dropleless therapy cannula. It was designed by Accutome for administration of dropleless cataract drug formulation. The AccuDrop Cannula is a blunt tip cannula that is designed to reduce zonular trauma. Sideport opening allows for gentle drug dispersion. Angled 90 degree shaft facilitates easier insertion into the anterior chamber to make a targeted drug delivery. Disposable, sold 10 per box.

AXI5581 [AccuDrop Cannula, 25g](#)

25 gauge.

AXI5630 [AccuDrop Cannula, 27g](#)

27 gauge.









REUSABLE CANNULAS & CYSTOTOMES



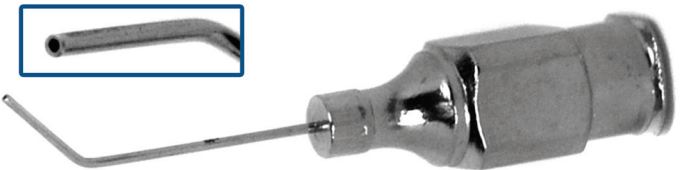



Item #	Description	Image
<b>Atkinson Retrobulbar Needle</b>		
Reusable Atkinson Retrobulbar Needles are available from 19 gauge to 27 gauge in size with straight shafts and sharp, beveled tips. Overall length: 35mm.		
AC0190 19	<b>Atkinson Retrobulbar Needle, 19g</b> 19 gauge.	
AC0190 20	<b>Atkinson Retrobulbar Needle, 20g</b> 20 gauge.	
AC0190 23	<b>Atkinson Retrobulbar Needle, 23g</b> 23 gauge.	
AC0190 25	<b>Atkinson Retrobulbar Needle, 25g</b> 25 gauge.	
AC0190 27	<b>Atkinson Retrobulbar Needle, 27g</b> 27 gauge.	

**Air Injection Cannula**

Reusable Air Injection Cannulas are available from 23 gauge to 30 gauge in size and have either an angled or straight shaft. Various tip types are available. Overall length: 19mm.

AC0125	<b>Air Injection Cannula, 23g</b> 23 gauge, angled shaft, 45-degree angle, 7mm from bend to tip, blunt tip.		
AC0145	<b>Air Injection Cannula, 25g</b> 25 gauge, angled shaft, 45-degree angle, 5mm from bend to tip, blunt tip.		
AC0110	<b>Air Injection Cannula, 27g</b> 27 gauge, angled shaft, 45-degree angle, 5mm bend to tip.		
AC0122	<b>Air Injection Cannula, 27g</b> 27 gauge, straight shaft.		
AC0105	<b>Air Injection Cannula, 27g</b> 27 gauge, angled shaft, 45-degree angle, 5mm from bend to tip, oval tip.		

REUSABLE CANNULAS & CYSTOTOMES

Item #	Description	Image
AC0120	<b>Air Injection Cannula, 27g</b> 27 gauge, angled shaft, 45-degree angle, 7mm bend to tip, blunt tip.	
AC0121	<b>Air Injection Cannula, 27g</b> 27 gauge, angled shaft, 8mm bend to tip.	
AC0130	<b>Air Injection Cannula, 30g</b> 30 gauge, angled shaft, 45-degree angle, 5mm bend to tip, blunt tip.	
AC0131	<b>Air Injection Cannula, 30g</b> 30 gauge, straight shaft, blunt tip.	
AC0140	<b>Air Injection Cannula, 30g</b> 30 gauge, angled shaft, 45-degree angle, 7mm bend to tip, blunt tip.	
AC0141	<b>Air Injection Cannula, 30g</b> 30 gauge, angled shaft, 45-degree angle, 8mm bend to tip, blunt tip.	

Gills-Welsh Aspirating Cannula

Reusable 25 gauge Gills-Welsh Aspirating Cannulas have 45-degree angled shafts with blunt, open tips. Various overall lengths and bend size.

AC0320 5	<b>Aspirating Cannula, 5mm Bend</b> 5mm from bend to tip. Overall length: 18mm.	
AC0320 7	<b>Aspirating Cannula, 7mm Bend</b> 7mm from bend to tip. Overall length: 21mm.	
AC0320 8	<b>Aspirating Cannula, 8mm Bend</b> 8mm from bend to tip. Overall length: 21mm.	
AC0320 10	<b>Aspirating Cannula, 10mm Bend</b> 10mm from bend to tip. Overall length: 21mm.	



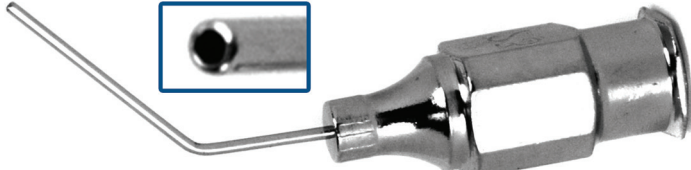
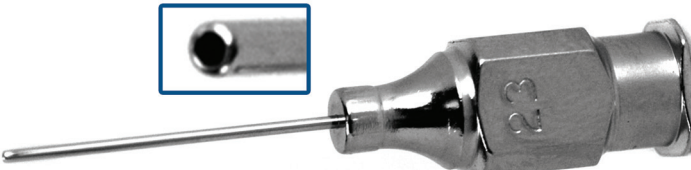
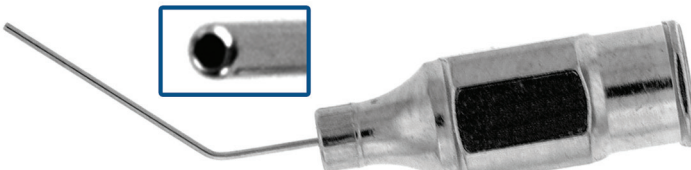
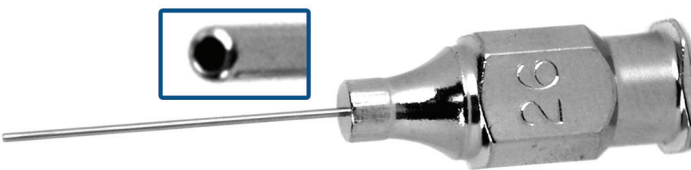
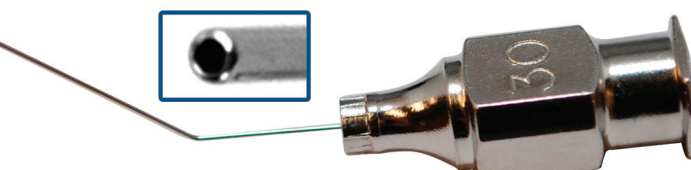
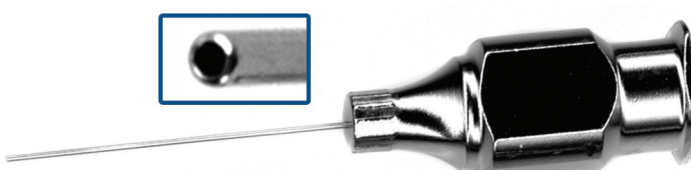

REUSABLE CANNULAS & CYSTOTOMES





Item #	Description	Image
<b>McIntyre Anterior Chamber Cannula</b>		
Reusable McIntyre Anterior Chamber Cannulas range from 23 gauge to 30 gauge and come in both angled and straight shaft patterns with blunt, open tips. Overall length: 18mm.		
AC0620	<p><b>McIntyre Cannula, 23g</b> 23 gauge, angled shaft, 45-degree angle, 12mm from bend to tip.</p>	 <p>The image shows a 23-gauge angled shaft cannula with a 45-degree bend. It includes a side view of the tip, a full view of the cannula, and a view of the handle with the number '23' engraved on it.</p>
AC0760	<p><b>McIntyre Cannula, 23g</b> 23 gauge, straight shaft.</p>	 <p>The image shows a 23-gauge straight shaft cannula. It includes a side view of the tip, a full view of the cannula, and a view of the handle with the number '23' engraved on it.</p>
AC0630	<p><b>McIntyre Cannula, 26g</b> 26 gauge, angled shaft, 45-degree angle, 12mm from bend to tip.</p>	 <p>The image shows a 26-gauge angled shaft cannula with a 45-degree bend. It includes a side view of the tip, a full view of the cannula, and a view of the handle with the number '26' engraved on it.</p>
AC0740	<p><b>McIntyre Cannula, 26g</b> 26 gauge, straight shaft.</p>	 <p>The image shows a 26-gauge straight shaft cannula. It includes a side view of the tip, a full view of the cannula, and a view of the handle with the number '26' engraved on it.</p>
AC0640	<p><b>McIntyre Cannula, 30g</b> 30 gauge, angled shaft, 45-degree angle, 12mm from bend to tip.</p>	 <p>The image shows a 30-gauge angled shaft cannula with a 45-degree bend. It includes a side view of the tip, a full view of the cannula, and a view of the handle with the number '30' engraved on it.</p>
AC0750	<p><b>McIntyre Cannula, 30g</b> 30 gauge, straight shaft.</p>	 <p>The image shows a 30-gauge straight shaft cannula. It includes a side view of the tip, a full view of the cannula, and a view of the handle with the number '30' engraved on it.</p>

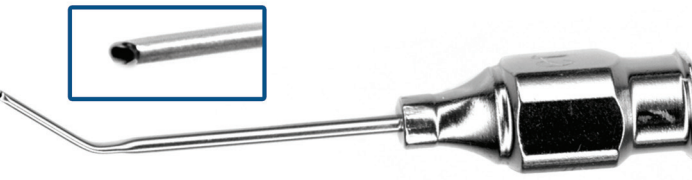
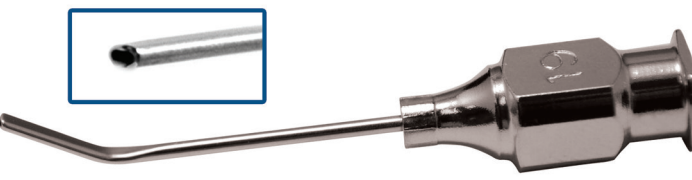
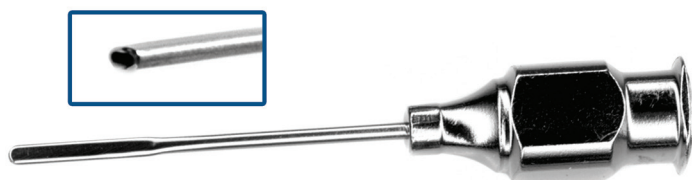
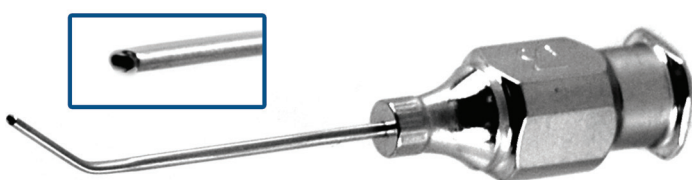

REUSABLE CANNULAS & CYSTOTOMES

Item #	Description	Image
<b>McIntyre-Binkhorst Irrigating Cannula</b>		
Reusable 26 gauge McIntyre-Binkhorst Irrigating Cannulas with angled or straight shafts. Tip is a 2.6mm wide J-shaped tip with a blunt front opening. Overall length: 18mm.		
AC0800	<b>McIntyre-Binkhorst Irrigating Cannula, Right</b> 26 gauge, angled right shaft, 13mm from bend to tip.	
AC0810	<b>McIntyre-Binkhorst Irrigating Cannula, Straight</b> 26 gauge, straight shaft.	
AC0820	<b>McIntyre-Binkhorst Irrigating Cannula, Left</b> 26 gauge, angled left shaft, 13mm from bend to tip.	
<b>Bishop-Harmon Irrigating Cannula</b>		
Reusable Bishop-Harmon Irrigating Cannulas are available from 18 gauge to 27 gauge in size and have angled or straight shafts. Tips are flattened and blunt. Overall length: 24mm.		
AC0230 18	<b>Bishop-Harmon Irrigating Cannula, 18g</b> 18 gauge, angled shaft, 35-degree angle, 7mm from bend to tip.	
AC0230 19	<b>Bishop-Harmon Irrigating Cannula, 19g</b> 19 gauge, angled shaft, 35-degree angle, 7mm from bend to tip.	
AC0231 19	<b>Bishop-Harmon Irrigating Cannula, 19g</b> 19 gauge, straight shaft.	
AC0230 21	<b>Bishop-Harmon Irrigating Cannula, 21g</b> 21 gauge, angled shaft, 35-degree angle, 7mm from bend to tip.	

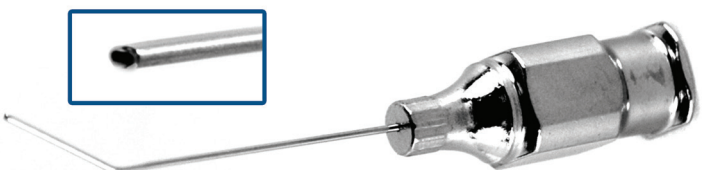
REUSABLE CANNULAS & CYSTOTOMES

Item #	Description	Image
AC0230 23	<b>Bishop-Harmon Irrigating Cannula, 23g</b> 23 gauge, angled shaft, 35-degree angle, 7mm from bend to tip.	
AC0230 25	<b>Bishop-Harmon Irrigating Cannula, 25g</b> 25 gauge, angled shaft, 35-degree angle, 7mm from bend to tip.	
AC0230 26	<b>Bishop-Harmon Irrigating Cannula, 26g</b> 26 gauge, angled shaft, 35-degree angle, 7mm from bend to tip.	
AC0230 27	<b>Bishop-Harmon Irrigating Cannula, 27g</b> 27 gauge, angled shaft, 35-degree angle, 7mm from bend to tip.	
AC0231 27	<b>Bishop-Harmon Irrigating Cannula, 27g</b> 27 gauge, straight shaft.	

**Bishop-Harmon Irrigating Cannula Bulb**

Bishop-Harmon Irrigating Cannula Bulb measures 25mm in diameter, translucent silicone. Overall length: 63mm.

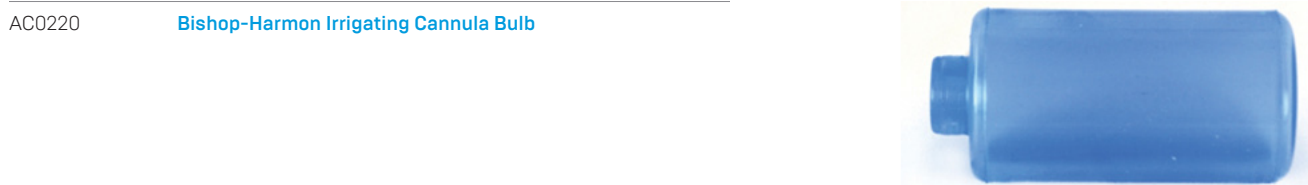

**Adapter for Irrigators**

Bishop-Harmon Adapter. Adapts to cannula hubs. Plastic, blue material. Overall length: 22mm.



REUSABLE CANNULAS & CYSTOTOMES

Item #	Description	Image
--------	-------------	-------

**Bishop-Harmon Irrigating Cannula Set**

Reusable Bishop-Harmon Irrigating Cannula Sets are available from 19 gauge to 25 gauge in size and have angled shafts. Each set includes 1 cannula, 1 adapter for irrigators (AC0230A), and 1 silicone bulb (AC0220).

AC0230 19 CS	<b>Bishop-Harmon Cannula Set, 19g</b> 19 gauge.
AC0230 23 CS	<b>Bishop-Harmon Cannula Set, 23g</b> 23 gauge.
AC0230 25 CS	<b>Bishop-Harmon Cannula Set, 25g</b> 25 gauge.



**Cystotome Cannula**

Reusable Cystotome Cannulas range from 25 gauge to 27 gauge with angled shafts that are 12mm from bend to tip. Cannulas have small cystotome sharp cutting edge tips and are irrigating. Overall length: 15mm.

AC4175	<b>Cystotome Cannula, 25g</b> 25 gauge.
AC4174	<b>Cystotome Cannula, 27g</b> 27 gauge.



**Lewicky Cystotome**

Angled shaft, 10mm from bend to tip, equilateral triangular tip, blunt base. Round handle. Overall length: 114mm.

AH0305	<b>Lewicky Cystotome</b>
--------	--------------------------



**Hydrodissection Cannula**

Hydrodissection cannulas ranging in gauge size from 23 gauge to 30 gauge with straight or angled shafts.

AC0460 23	<b>Hydrodissection Cannula, 23g</b> 23 gauge, angled shaft, 35 degree angle 8mm from bend to tip, flattened horizontal tip. Overall length: 22mm.
AC0460	<b>Hydrodissection Cannula, 25g</b> 25 gauge, angled shaft, 35 degree angle 8mm from bend to tip, flattened horizontal tip. Overall length: 22mm.
AC0465	<b>Hydrodissection Cannula, 25g</b> 25 gauge, straight shaft, 2.5mm J-shaped tip with 0.3mm flattened tip. Overall length: 18mm.

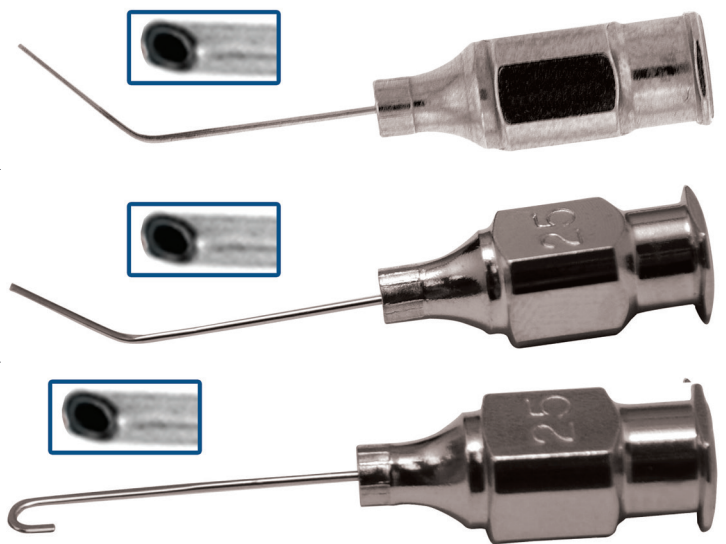

REUSABLE CANNULAS & CYSTOTOMES

Item #	Description	Image
AC0485	<p><b>Hydrodissection Cannula, 25g</b>                      25 gauge, straight shaft, 3mm wide U-shaped tip. Overall length: 25mm.</p>	
AC0459	<p><b>Hydrodissection Cannula, 25g</b>                      25 gauge, angled shaft, 11mm from bend to tip, flattened tip. Overall length: 22mm.</p>	
AC0462	<p><b>Hydrodissection Cannula, 25g</b>                      25 gauge, angled left shaft, 10mm from bend to tip, 3mm wide U-shaped tip. Overall length: 25mm.</p>	
AC0463	<p><b>Hydrodissection Cannula, 25g</b>                      25 gauge, angled right shaft, 10mm from bend to tip, 3mm wide U-shaped tip. Overall length: 25mm.</p>	
AC0457	<p><b>Hydrodissection Cannula, 27g</b>                      27 gauge, angled shaft, 11mm from bend to tip, flattened tip. Overall length: 22mm.</p>	
AC0467	<p><b>Hydrodissection Cannula, 27g</b>                      27 gauge, straight shaft, J-shaped tip. Overall length: 25mm.</p>	
AC0469	<p><b>Hydrodissection Cannula, 27g</b>                      27 gauge, angled left shaft, 10mm from bend to tip, 3mm wide U-shaped tip. Overall length: 25mm.</p>	
AC0461	<p><b>Hydrodissection Cannula, 27g</b>                      27 gauge, angled shaft, 35-degree angle 8mm from bend to tip, flattened horizontal tip. Overall length: 22mm.</p>	



REUSABLE CANNULAS & CYSTOTOMES

Item #	Description	Image
AC0473	<p><b>Hydrodissection Cannula, 27g</b></p> <p>27 gauge, angled right shaft, 10mm from bend to tip, 3mm wide U-shaped tip. Overall length: 25mm.</p>	
AC0458	<p><b>Hydrodissection Cannula, 30g</b></p> <p>30 gauge, angled shaft, 11mm from bend to tip, flattened tip. Overall length: 22mm.</p>	
AC0466	<p><b>Hydrodissection Cannula, 30g</b></p> <p>30 gauge, straight shaft, J-shaped tip. Overall length: 25mm.</p>	

**Akahoshi II Hydrodissection Cannula**

27 gauge, curved shaft, 1mm bend to tip, beveled tip. Overall length: 19mm.

AC0478	<p><b>Akahoshi II Hydrodissection Cannula</b></p>	
--------	---	--

**Chang Nucleus Hydrodissection Cannula**

Reusable Chang Nucleus Hydrodissection Cannulas come in 27 gauge with 90-degree angled shafts and flat tips with beveled openings. Overall length: 16mm.

AC0475	<p><b>1.5mm Chang Hydrodissection Cannula</b></p> <p>1.5mm flat standard tip.</p>	
AC0476	<p><b>3mm Chang Hydrodissection Cannula</b></p> <p>3.0mm flat long tip.</p>	

REUSABLE CANNULAS & CYSTOTOMES

Item #	Description	Image
--------	-------------	-------

**Simcoe Cortex Extractor Cannula**

Reusable 23 and 25 gauge Simcoe Cortex Extractor Cannulas with 13mm and 21mm curved shafts. Cannulas have closed rounded tips with a 0.3mm aspiration port that faces into the shaft. Overall length: 21mm.

ACI030 21	<b>Simcoe Cannula, 23g</b> 23 gauge, 21mm curved shaft.
ACI030 13	<b>Simcoe Cannula, 23g</b> 23 gauge, 13mm curved shaft.
ACI030 25	<b>Simcoe Cannula, 25g</b> 25 gauge, 21mm curved shaft.



**Infusion Cannula**

Infusion cannulas ranging from 20 gauge to 23 gauge, come with tubing and luer-adapter.

AC0665	<b>Infusion Cannula, 20g</b> 20 gauge, 6mm beveled tip luer-adapter, comes with 26cm tubing.
AC0666	<b>Infusion Cannula, 20g</b> 20 gauge, 4mm beveled tip luer-adapter, comes with 26cm tubing.
AC0675	<b>Infusion Cannula, 22g</b> 22 gauge, angled luer-adapter, 7mm from bend to tip, self-retaining beveled tip, comes with silicone tubing and luer-adapter.
AC2262	<b>Infusion Cannula, 23g</b> 23 gauge, 5mm beveled tip luer-adapter, comes with 26cm tubing.
AC2263	<b>Infusion Cannula, 23g</b> 23 gauge, 6mm beveled tip luer-adapter, comes with 26cm tubing.



**Anis Cortex Aspirating Cannula**

23 gauge, angled shaft, 35-degree angle, thin wall, 1.5mm from bend to tip, 0.4mm sideport opening, sandblasted tip. Reusable. Overall length: 26mm.

AC0160	<b>Anis Cortex Aspirating Cannula</b>
--------	---------------------------------------

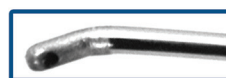

**Graether Collar Button Cannula**

23 gauge Graether Collar Button Cannulas with straight or curved shafts. Collar button tip with roughened posterior surface.

AC0390	<b>Collar Button Cannula, Straight</b> Straight shaft. Overall length: 25mm.
--------	---





REUSABLE CANNULAS & CYSTOTOMES

Item #	Description	Image
AC0400	<p><b>Collar Button Cannula, Angled</b></p> <p>Angled shaft, 45-degree angle, 10mm from bend to tip. Overall length: 22mm.</p>	

**Infusion Handle**

Reusable Infusion Handles that are made from stainless steel. Available with various connectors and overall lengths.

AC1300	<p><b>Male Infusion Handle</b></p> <p>Male to male connector. Overall length: 10cm.</p>	
--------	---	--

AC1305	<p><b>Female Infusion Handle</b></p> <p>Male to female luer lock connector. Overall length: 10cm.</p>	
--------	---	--

AC6540	<p><b>Tubing Infusion Handle</b></p> <p>Male to tubing connector. Overall length: 7.5cm.</p>	
--------	--	--

AC1301	<p><b>Tubing Infusion Handle</b></p> <p>Male to tubing connector. Overall length: 11.5cm.</p>	
--------	---	--

**Henderson MICS Capsule Polisher Cannula**

23 gauge, curved shaft, 0.3mm port facing down, lightly sandblasted 1.25mm saucer-shaped tip. Overall length: 21mm.

AC2155	<p><b>Henderson MICS Capsule Polisher Cannula</b></p>	
--------	---	--

REUSABLE CANNULAS & CYSTOTOMES

Item #	Description	Image
--------	-------------	-------

**Jensen Capsule Polisher**

Reusable Jensen Capsule Polishers are available in 23 gauge and 25 gauge with curved shafts. Whole capsule and posterior capsule polishers are available with carbide impregnated sandblasted tips. Overall length: 28mm.

AC2140	<b>Posterior Capsule Polisher, 23g</b> Posterior capsule polisher, 23 gauge.	
AC2130	<b>Posterior Capsule Polisher, 25g</b> Posterior capsule polisher, 25 gauge.	
AC2110	<b>Capsule Polisher, 23g</b> Whole capsule polisher, 23 gauge.	
AC2120	<b>Capsule Polisher, 25g</b> Whole capsule polisher, 25 gauge.	

**Gills-Welsh Olive Tip Cannula**

25 gauge, angled shaft, 45-degree angle, 10mm from bend to tip, 1mm stainless steel ball tip. Overall length: 26mm.

AC0350	<b>Gills-Welsh Olive Tip Cannula</b>	
--------	--------------------------------------	---

**Lacrimal Cannula**

Lacrimal cannulas ranging from 20 gauge to 27 gauge with various shafts and tips.

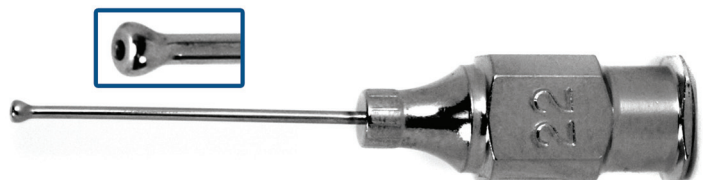
AC0584	<b>Lacrimal Cannula, 20g</b> 20 gauge, straight shaft, blunt closed tip with sideport opening. Overall length: 28mm.	
AC0590	<b>Lacrimal Cannula, 22g</b> 22 gauge, malleable straight shaft, blunt flared probe tip. Overall length: 19mm.	
AC0560	<b>Lacrimal Cannula, 23g</b> 23 gauge, curved 19 gauge reinforced shaft, 10mm tip, open blunt tip. Overall length: 31mm.	
AC0570	<b>Lacrimal Cannula, 23g</b> 23 gauge, straight 19 gauge reinforced shaft, 12mm blunt open tip. Overall length: 32mm.	

REUSABLE CANNULAS & CYSTOTOMES

Item #	Description	Image
AC0580	<b>Lacrimal Cannula, 23g</b> 23 gauge, straight shaft, blunt open tip. Overall length: 25mm.	
AC0583	<b>Lacrimal Cannula, 25g</b> 25 gauge, straight shaft, blunt open tip. Overall length: 25mm.	
AC0560 27	<b>Lacrimal Cannula, 27g</b> 27 gauge, curved 19 gauge reinforced shaft, 10mm tip, open blunt tip. Overall length: 32mm.	
AC0561	<b>Lacrimal Cannula, 27g</b> 27 gauge, straight 19 gauge reinforced shaft, 12mm tip, open blunt tip. Overall length: 32mm.	
AC0582	<b>Lacrimal Cannula, 27g</b> 27 gauge, straight shaft, blunt open tip. Overall length: 25mm.	

**Bailey Lacrimal Cannula**

Reusable reinforced Bailey Lacrimal Cannulas are available in 23 gauge or 27 gauge with straight, 19 gauge reinforced shafts. Tips are 6mm in size and have a blunt, open end. Overall length: 14mm.

AC0200	<b>Bailey Lacrimal Cannula, 23g</b> 23 gauge.	
AC0201	<b>Bailey Lacrimal Cannula, 27g</b> 27 gauge.	

**Fasanella Lacrimal Cannula**

Reusable Fasanella Lacrimal Cannulas ranging from 23 gauge to 27 gauge with gently curved reinforced shafts and 22mm open, blunt tips. Overall length: 42mm.

AC0565	<b>Lacrimal Cannula, 23g</b> 23 gauge, 19 gauge reinforced shaft.	
AC0566	<b>Lacrimal Cannula, 25g</b> 25 gauge, 20 gauge reinforced shaft.	
AC0567	<b>Lacrimal Cannula, 27g</b> 27 gauge, 21 gauge reinforced shaft.	

REUSABLE CANNULAS & CYSTOTOMES

Item #	Description	Image
--------	-------------	-------

**Simcoe I/A Cannula**

23 gauge, curved thin wall shaft, 0.3mm aspiration through top port, irrigation through side opening, comes with 10-inch tubing and luer-lock adapter. Overall length: 15mm.

AC1040	<a href="#">Simcoe I/A Cannula</a>	
--------	------------------------------------	--



**Slade LASIK Cannula**

26 gauge, angled shaft, 9mm from bend to tip, flattened spatulated tip with front port opening. Overall length: 16mm.





AC5400	<a href="#">Slade Cannula, 26g</a>	
--------	------------------------------------	--



# Capsule Polishers



## NON-IRRIGATING CAPSULE POLISHERS

Item #	Description	Image
<b>Accutome Capsule Polishing Sweeper and Curette</b>		
Double-ended, one angled shaft with sweeper tip, 10mm from bend to tip, rounded, teardrop shaped, flat tip, 0.8mm wide. One straight shaft with ring curette, 90 degree angled ring tip, 1.8mm in diameter. Round handle. Overall length: 147mm.		
AH0228	<a href="#">Accutome Capsule Polisher</a>	
<b>Gills-Welsh Capsule Polishing Curette</b>		
Angled shaft, 8mm from bend to tip, 2mm diameter cup tip. Flat handle. Overall length: 121mm.		
AH0130	<a href="#">Gills-Welsh Capsule Curette</a>	
<b>Holladay Posterior Capsule Polisher and Curette</b>		
Straight shaft, 0.5mm diameter tip, sandblasted side on reverse of curette. Round handle. Overall length: 127mm.		
AH0240	<a href="#">Holladay Posterior Capsule</a>	
<b>Nightingale Posterior Capsule Polishing Curette</b>		
Angled shaft, open ring tip, 1.75 diameter, semi-sharp edge. Round handle. Overall length: 124mm.		
AH0220	<a href="#">Nightingale Polishing Curette</a>	
<b>Shepherd Capsule Polishing Curette</b>		
Angled shaft, 10mm from bend to tip, 1.75mm diameter ring tip, semi-sharp top and bottom edges. Flat handle. Overall length: 121mm.		
AH0225	<a href="#">Shepherd Capsule Polisher</a>	



**NON-IRRIGATING CAPSULE POLISHERS**

Item #	Description	Image
--------	-------------	-------

**Singer Sweep Polisher**

Double-ended, angled shafts, angled left and right, 10mm from bend to tip, rounded paddle tips, 0.75mm wide tips. Round handle. Overall length: 148mm.

AH7210 [Singer Sweep Polisher](#)



**Whitman Sheperd Capsule Polisher**

Double-ended, angled shafts, angled left and right, 10mm from bend to tip, low profile ring tips, 1.75mm diameter rings, semi-sharp top and bottom edges of rings. Round handle. Overall length: 145mm.

AH0226 [Whitman Sheperd Polisher](#)



**Accutome 360-Degree Capsule Polishing Curette**

Angled shaft, 13mm from bend to tip, unique multi-bend tip, 1.60mm diameter ring tip with semi-sharp top and bottom edges. Round handle. Overall length: 121mm.









AH0222 [360-Degree Capsule Polisher](#)





# Chalazion Instruments

CURETTES

Item #	Description	Image
<b>Heath Chalazion Ring Curette</b>		
Straight shaft, ring height 1.5mm. Round handle. Overall length: 131mm.		
AH0140	<b>Heath Chalazion Curette, No. 1</b> 1mm diameter ring.	
AH0150	<b>Heath Chalazion Curette, No. 2</b> 2mm diameter ring.	
AH0160	<b>Heath Chalazion Curette, No. 3</b> 3mm diameter ring.	
<b>Meyerhoeffer Chalazion Curette</b>		
Straight 3mm shaft and various cup sizes. Flat handle.		
AH0170	<b>Chalazion Curette, Number 0 Cup</b> 1.5mm cup. Overall length: 125mm.	
AH0180	<b>Chalazion Curette, Number 1 Cup</b> 1.75mm cup. Overall length: 125mm.	
AH0190	<b>Chalazion Curette, Number 2 Cup</b> 2.0mm cup. Overall length: 124mm.	
AH0200	<b>Chalazion Curette, Number 3 Cup</b> 2.5mm cup. Overall length: 124mm.	
AH0210	<b>Chalazion Curette, Number 4 Cup</b> 3.5mm cup. Overall length: 125mm.	

# Lens Manipulators & Choppers

LENS MANIPULATORS

Item #	Description	Image
--------	-------------	-------

**Anis Ball Tip Nucleus Manipulator**

Angled shaft, 10mm from bend to tip, ball tip, 0.5mm diameter tip. Round handle. Overall length: 115mm.

AH4450	<a href="#">Anis Ball Tip Nucleus Manipulator</a>	
--------	---	--



**Barrett Duo Nucleus Rotator/Manipulator/Splitter**

Titanium, double-ended, angled shafts, 14mm from bend to tip, straight sharp inner/outer sides of splitter tip, cutting edge 90 degrees to axis, 10mm from bend to tip, 0.65mm mushroom tip manipulator. Round handle. Overall length: 121mm.

AH4282	<a href="#">Round Handle Nucleus Rotator</a>	
--------	--	--



**Bechert Lens Pusher**

Angled shaft, 7mm from bend to tip, Y-shaped tip, vertical rotator tip. Round handle. Overall length: 124mm.

AH1580	<a href="#">Bechert Lens Pusher</a>	
--------	-------------------------------------	--

**Bechert Nucleus Rotator**

Angled shaft, 7mm from bend to tip, Y-shaped tip. Round handle. Overall length: 120mm.

AH4100	<a href="#">Stainless Steel Rotator</a>	
	Stainless steel handle.	

AH4100T	<a href="#">Titanium Rotator</a>	
	Titanium handle.	

**Clayman Nucleus Rotator**







Angled shaft, 10mm from bend to tip, V-notched tip, 0.5mm wide flat spatula. Flat handle. Overall length: 121mm.

AH4110	<a href="#">Clayman Nucleus Rotator</a>	
--------	---	--



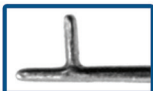
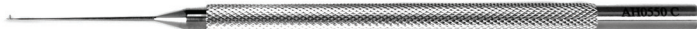

LENS MANIPULATORS

Item #	Description	Image
<b>Drysdale Nucleus Manipulator</b>		
Angled shaft, 10mm from bend to tip, flattened paddle tip. Round handle.		
AH4120	<b>Drysdale Nucleus Manipulator</b> Overall length: 110mm	
AH4125	<b>Drysdale Manipulator Anterior</b> Anterior capsule polisher. Overall length: 112mm.	
<b>Fenzel Lens Manipulating Hook</b>		
Angled and straight shaft, 0.15mm diameter tip. Round handle.		
AH0560	<b>Fenzl Lens Manipulating Hook, Angled</b> Angled shaft, 10mm from bend to tip. Overall length: 115mm.	
		
AH0550	<b>Fenzl Lens Manipulating Hook, Straight</b> Straight shaft, T-shaped tip. Overall length: 121mm.	
		
<b>Grayson Nucleus Manipulator</b>		
Angled shaft, 10mm from bend to tip, 0.8mm flat, olive-shaped tip, flattened with smooth, defined internal edge. Round handle. Overall length: 115mm.		
AH4121	<b>Grayson Nucleus Manipulator</b>	
<b>Grayson/Kuglen Double-Ended Manipulator</b>		
Double-ended, angled shafts, 10mm from bend to tip, 0.8mm flat olive shaped tip, 9mm from bend to tip, push/pull model, H-shaped. Round handle. Overall length: 140mm.		
AH4122	<b>Grayson-Kuglen Double-Ended Manipulator</b>	

LENS MANIPULATORS

Item #	Description	Image
--------	-------------	-------

**Hunkeler IOL Manipulator**

Angled shaft, 10mm from bend to tip, slightly curved, 0.3mm diameter hemi-ball tip. Round handle. Overall length: 115mm.

AH1510	<a href="#">Hunkeler IOL Manipulator</a>	



**Jaffe-Bechert Nucleus Rotator**

Angled shaft, 9mm from bend to tip, Y-shaped tip. Round handle. Overall length: 120mm.

AH4140	<a href="#">Stainless Steel Rotator</a>	
	Stainless steel handle.	

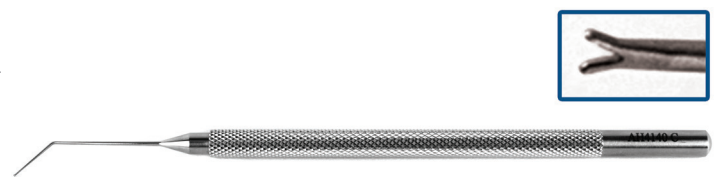
AH4140TI	<a href="#">Titanium Rotator</a>	
	Titanium handle.	



**Koch Phacoemulsification Manipulator**

Curved shaft, 0.8mm wide, duckbill shaped tip. Round handle. Overall length: 115mm.

AH5380	<a href="#">Koch Phaco Manipulator</a>	

**Koch Stop and Chop Manipulator**

Angled shaft, 10mm from bend to tip, 1.5mm long tip. Round handle. Overall length: 118mm.

AH5385	<a href="#">Koch Stop and Chop Manipulator</a>	









**Lester IOL Manipulator**

Hourglass/teardrop-shaped tip, 0.25mm tip. Round handle. Overall length: 115mm.

AH1520	<a href="#">Vaulted IOL Manipulator</a>	
	Vaulted shaft, 10mm from bend to tip.	



LENS MANIPULATORS

Item #	Description	Image
AHI530	<b>Angled IOL Manipulator</b> Angled shaft, 10mm from bend to tip.	 
AHI530T	<b>Angled IOL Manipulator</b> Titanium, angled shaft, 10mm from bend to tip.	 
AHI540	<b>Straight IOL Manipulator</b> Straight shaft.	 
AHI540T	<b>Straight IOL Manipulator</b> Titanium, straight shaft.	 



**Lewicky Lens Manipulator Hook**

Angled shaft, 9mm from bend to tip, slightly curved, 0.15mm tip. Flat handle. Overall length: 115mm.

AHI140	<b>Lewicky Lens Manipulator Hook</b>	
--------	--------------------------------------	--

**Lieberman Microfinger Nucleus Manipulator**

Angled shaft, 10mm from bend to tip, unique C-shaped microfinger tip. Round handle. Overall length: 115mm.

AH0860	<b>Right Microfinger Nucleus Manipulator</b> Right-hand use.	
AH0870 C	<b>Left Microfinger Nucleus Manipulator</b> Left-hand use.	

LENS MANIPULATORS

Item #	Description	Image
--------	-------------	-------

**Lindstrom STAR Manipulator**

Titanium, angled shaft, 12mm from bend to tip, multi-directional cross action star tip. Round handle. Overall length: 117mm.

AH0695T [Lindstrom STAR Manipulator](#)



**Mackool Double-Ended Chopper and Spatula**

Double-ended, angled shafts, 10mm from bend to tip. Micro 0.38mm ball-shaped blunt tip. Interior cutting edge, 11mm from bend to tip, cylindrical spatula, 0.4mm blade. Round handle. Overall length: 138mm.

AH7125 [Mackool Double-Ended Chopper and Spatula](#)



**Maloney No Hole IOL Manipulator**

Straight shaft, vaulted 7mm from tip, 0.25mm diameter teardrop shaped tip. Round handle. Overall length: 118mm.

AH1550 [Maloney No Hole IOL Manipulator](#)



**Maloney Nucleus Rotator**

Double-ended, angled shafts, 12mm from bend to tips, 0.5mm spatula tip, 0.6mm forked tip. Round handle. Overall length: 134mm.

AH4135 [Maloney Nucleus Rotator](#)







**Maltsman-Fenzel Lens Manipulating Hook**

Straight and angled shafts, V-shaped tip, 0.15mm tip. Round handle. Overall length: 118mm.



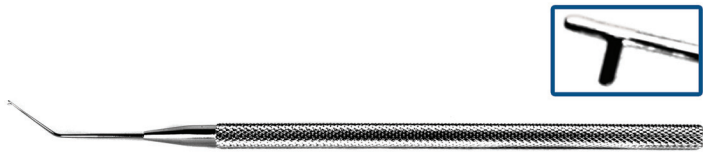

AH0680 [Maltzman-Fenzl Lens Hook, Straight](#)  
Straight shaft.



LENS MANIPULATORS







Item #	Description	Image
AH0690	<p><b>Maltzman-Fenzl Lens Hook, Angled</b>                      Angled shaft, 10mm from bend to tip.</p>	 <p>The image shows a long, thin, angled metal shaft with a fine, knurled texture. The tip is bent at an angle. An inset image in the top right corner provides a magnified view of the hook-shaped tip.</p>
<b>Hunkeler IOL Manipulator</b>		
<p>Angled shaft, hemi-ball tip, 0.3mm diameter tip. Round handle. Overall length: 105mm.</p>		
AH1560	<p><b>Hunkeler IOL Manipulator</b></p>	 <p>The image shows a long, thin, angled metal shaft with a fine, knurled texture. The tip is bent at an angle and has a small hemi-ball tip. The handle is round and smooth.</p>
<b>Masket Phaco Spatula</b>		
<p>Double-ended, angled shafts, 9mm from bend to tip, phaco splitter. 60-degree interior cutting edge, blunt tip, 12mm from bend to tip, cylindrical spatula, flat disc shaped tip. Round handle. Overall length: 136mm.</p>		
AH4300	<p><b>Masket Phaco Spatula</b></p>	 <p>The image shows a long, thin, double-ended metal shaft with a fine, knurled texture. Both ends are bent at an angle. The handle is round and smooth.</p>
<b>Nordan Capsule Elevator</b>		
<p>Angled shaft, used for placing IOL in the bag. Round handle.</p>		
AH1570	<p><b>Nordan Capsule Elevator</b></p>	 <p>The image shows a long, thin, angled metal shaft with a fine, knurled texture. The tip is bent at an angle and has a small, rounded, hook-like tip. An inset image in the top right corner provides a magnified view of the tip.</p>
<b>O'Gawa Lens Dialer</b>		
<p>Angled shaft, 10mm from bend to tip, collar button style tip. Round handle. Overall length: 118mm.</p>		
AH4220	<p><b>O'Gawa Lens Dialer</b></p>	 <p>The image shows a long, thin, angled metal shaft with a fine, knurled texture. The tip is bent at an angle and has a small, rounded, collar button style tip. An inset image in the top right corner provides a magnified view of the tip.</p>

LENS MANIPULATORS





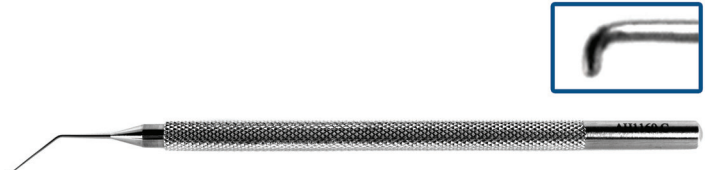









Item #	Description	Image
<b>Osher "Y" IOL Hook</b>		
Straight shaft, Y-shaped tip. Round handle. Overall length: 124mm.		
AH0710	<a href="#">Osher "Y" IOL Hook</a>	
<b>Osher Iris Retractor</b>		
Straight shaft, oval button tip. Round handle. Overall length: 121mm.		
AH2135	<a href="#">Osher Iris Retractor</a>	
<b>Osher Nucleus Manipulator</b>		
Straight shaft, blunt finger-like tip, 0.5mm two-prong, K-shaped tip. Round handle. Overall length: 114mm.		
AH0730	<a href="#">Osher Nucleus Manipulator</a>	
<b>Pisacano Nucleus Rotator</b>		
Angled shaft, 10.5mm from bend to tip, 1mm disc shaped tip. Round handle. Overall length: 115mm.		
AH4160	<a href="#">Horizontal Nucleus Rotator</a> Horizontal disc-shaped tip.	
AH4161	<a href="#">Vertical Nucleus Rotator</a> Vertical disc-shaped tip.	



LENS MANIPULATORS

Item #	Description	Image
<b>Rentsch Boat Hook Lens Manipulator</b>		
Straight shaft, split hook tip. Round handle. Overall length: 115mm.		
AH0740	<a href="#">Rentsch Boat Hook Lens Manipulator</a>	
<b>Siepser Endocapsular Controller</b>		
Angled shaft, 12mm from bend to tip, 0.7mm trumpet-shaped tip. Round handle. Overall length: 118mm.		
AH4190	<a href="#">Siepser Endocapsular Controller</a>	
<b>Sinskey C-Hook, Modified</b>		
Curved shaft, 10mm from tip to first bend, offset shaft, 0.2mm diameter tip, blunt. Flat handle. Overall length: 120mm.		
AH1150	<a href="#">Sinskey C-Hook, Modified</a>	
<b>Sinskey Lens Manipulating Hook</b>		
Straight and angled shafts with 0.2mm or 0.25mm diameter blunt tip.		
AH1155	<a href="#">Sinskey Hook, Angled</a> Angled shaft, 12mm from bend to tip, 0.2mm diameter blunt tip reversed. Round handle. Overall length: 115mm.	
AH1160	<a href="#">Sinskey Hook, Angled</a> Angled shaft, 10mm from bend to tip, 0.2mm diameter blunt tip. Round handle. Overall Length: 111mm.	
AH1165	<a href="#">Sinskey Hook, Straight</a> Straight shaft, 0.2mm diameter blunt tip. Round handle. Overall length: 115mm.	

LENS MANIPULATORS

Item #	Description	Image
AH1170	<b>Sinskey Hook, Angled</b> Angled shaft, 10mm from bend to tip, 0.2mm diameter blunt tip. Flat handle. Overall length: 115mm.	 
AH1175	<b>Sinskey Hook, Straight</b> Straight shaft, 0.2mm diameter blunt tip. Flat handle. Overall length: 120mm.	 
AH1210	<b>Sinskey Hook, Angled</b> Titanium. Angled shaft, 10mm from bend to tip, 0.2mm diameter blunt tip. Round handle. Overall length: 115mm.	 
AH1110	<b>Sinskey Hook, Angled</b> Angled shaft, 10mm from bend to tip, 0.25mm diameter blunt tip. Flat handle. Overall length: 115mm.	 
AH1200	<b>Sinskey Hook, Angled</b> Angled shaft, 10mm from bend to tip, 0.25mm diameter blunt tip. Round handle. Overall length: 115mm.	 
AH1190	<b>Sinskey Hook, Straight</b> Straight shaft, 0.25mm diameter blunt tip. Round handle. Overall length: 120mm.	 
AH1190TI	<b>Sinskey Hook, Straight</b> Titanium, straight shaft, 0.25mm diameter blunt tip. Round handle. Overall length: 120mm.	 

**Tennant Nucleus Manipulator**

Angled shaft, 10mm from bend to tip, 0.37mm ball shaped tip. Round handle. Overall length: 118mm.











AH4200	<b>Tennant Nucleus Manipulator</b>	
--------	------------------------------------	--

CHOPPERS

Item #	Description	Image
--------	-------------	-------

**Accutome Wand**

The Accutome Wands are made from titanium and stainless steel. They are available with straight and angled shafts and curved and angled tips with a 0.5mm diameter ball. Round handle. Overall length: 115mm.

AH7100T	<p><b>Straight Wand</b></p> <p>Titanium, straight shaft, curved tip.</p>	 
AH7101	<p><b>Curved Wand</b></p> <p>Stainless steel, curved shaft, curved tip.</p>	 
AH7105T	<p><b>Angled Wand</b></p> <p>Titanium, angled shaft, 10.0mm from bend to tip.</p>	 
AH7106T	<p><b>Angled Wand</b></p> <p>Titanium, angled shaft, 10mm from bend to tip, 90-degree angled tip.</p>	 
AH7107T	<p><b>Straight Wand</b></p> <p>Titanium, straight shaft, 90-degree angled tip.</p>	 

**Akahoshi Nucleus Sustainer**

Angled shaft, 10mm from bend to tip, paddle-shaped blade, right side dished out. Round handle. Overall length: 115mm.

AH7110	<p><b>Akahoshi Nucleus Sustainer</b></p>	
--------	--	--

CHOPPERS

Item #	Description	Image
--------	-------------	-------

**Ambidextrous Seibel Nucleus Chopper**

Angled shaft, 15mm from bend to tip, curved interior cutting edge, 0.5mm olive-shaped tip. Ambidextrous, round handle. Overall length: 117mm.

AH4173	<a href="#">Ambidextrous Seibel Nucleus Chopper</a>	
--------	---	---



**Castroviejo Dissector**

Angled shaft, 5mm from bend to tip, 1.5mm wide x 5mm flat angled blade. Flat handle. Overall length: 119mm.

AH6545	<a href="#">Castroviejo Dissector</a>	
--------	---------------------------------------	--



**Chang Microfinger Phaco Chopper and Quick Chopper**

Double-ended, angled shafts, 10mm from bend to tip, C-shaped blunt chopper tip, 1.0mm pointed sharp quick chop tip. Round handle. Overall length: 137mm.

AH4290	<a href="#">Left Chopper</a> Left-hand use.	
--------	--	--

AH4295	<a href="#">Right Chopper</a> Right-hand use.	
--------	--	---

AH4290T	<a href="#">Left Chopper</a> Titanium, left-hand use.	
---------	--	--



**Chang-Seibel Microfinger Chopper and Vertical Safety Chopper**

Double-ended, angled shafts, 10mm from bend to tips, unique C-shaped microfinger chopper with blunt tip, 0.5mm olive-shaped blade with 1.0mm bend. Round handle. Overall length: 138mm.

AH4289	<a href="#">Right Chopper</a> Right-hand use.	
--------	--	--

AH4288	<a href="#">Left Chopper</a> Left-hand use.	
--------	--	---



**Davidoff Ambidextrous Nucleus Chopper**

Angled shaft, 10mm from bend to tip, blunt tip, triangle-shaped cutting edge. Ambidextrous use, round handle. Overall length: 115mm.

AH4205	<a href="#">Stainless Steel Davidoff Nucleus Chopper</a> Stainless steel.	
--------	--	--

AH4205T	<a href="#">Titanium Davidoff Nucleus Chopper</a> Titanium.	
---------	--	--



CHOPPERS

Item #	Description	Image
--------	-------------	-------

**Dodick-Kammann Nucleus Chopper**

Angled shaft, 12mm from bend to tip, 2mm long interior cutting edge, blunt tip. Round handle. Overall length: 112mm.

AH4236 [Dodick-Kammann Nucleus Chopper](#)



**Escaf Nucleus Sustainer**

Angled shaft, 10mm from bend to tip, smooth ball tip. Round handle. Overall length: 115mm.

AH7130 [Escaf Nucleus Sustainer](#)



**Fukasaku Snapper Chopper**

Angled shaft, 10mm from bend to tip, blunt tip, wedge shaped interior cutting edge. Round handle. Overall length: 118mm.

AH4210 [Fukasaku Nucleus Chopper](#)



**Goldberg Sideport Splitter**

Angled shaft, 10mm from bend to tip, 0.8mm flat teardrop shaped tip, blunt. Round handle. Overall length: 113mm.

AH4115 [Goldberg Sideport Splitter](#)



**Haefliger Phaco Cleaver**

Angled shaft, 10mm from bend to tip, dull, curved cleaver tip. Round handle. Overall length: 115mm.

AH4216 [Haefliger Phaco Cleaver, Right](#)  
Right-hand use.

AH4215 [Haefliger Phaco Cleaver, Left](#)  
Left-hand use.



CHOPPERS

Item #	Description	Image
--------	-------------	-------

**He Hook Chopper**

Titanium, angled shaft, 10.5mm from bend to tip, interior cutting edge, hook shaped tip, blunt tip. Round handle. Overall length: 113mm.

AH4380	<b>Right Hook Chopper</b> Right-hand use.
--------	--

AH4381	<b>Left Hook Chopper</b> Left-hand use.
--------	--



**Keener Lens/Nucleus Divider**

One preformed snare wire loop. Round handle. Comes with three additional loops.

AH3215	<b>Nucleus Divider</b>
--------	------------------------



**Koch Spatula and Nagahara Chopper**

Double-ended, curved shaft, 0.8mm wide spatula duckbill-shaped tip, angled shaft, 10mm from bend to tip. 1.5mm, 60-degree chopper cutting edge. Round handle. Overall length: 126mm.

AH4195	<b>Koch Spatula and Nagahara Chopper</b>
--------	--



**Lieberman Microfinger and Spatula**

Double-ended, angled shafts, 10mm from bend to tip. C-shaped chopper, blunt tip, 0.5mm wide flat spatula. Round handle. Overall length: 142mm.

AH0880	<b>Right Microfinger/Spatula</b> Right-hand use.
--------	---

AH0890	<b>Left Microfinger/Spatula</b> Left-hand use.
--------	---



**Mackool Phaco Chopper**

Angled shaft, 10mm from bend to tip, micro ball shaped tip, blunt, interior cutting edge. Round handle. Overall length: 114mm.

AH4145	<b>Stainless Steel Chopper</b> Stainless steel.
--------	--

AH7115	<b>Titanium Chopper</b> Titanium.
--------	--------------------------------------











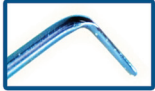

CHOPPERS

Item #	Description	Image
<b>Mackool Phaco Chopper and Nucleus Chopper</b>		
Double-ended. Round handle.		
AH4375	<b>Mackool Double-Ended Chopper, Right</b> Right-hand use.	
AH4376	<b>Mackool Double-Ended Chopper, Left</b> Left-hand use.	
<b>Maloney Quick-Chop</b>		
Titanium. Double-ended, angled shafts, 9mm from bend to tip, quick-chop tip, 10mm from bend to tip, micro sharp pick tip. Round handle. Overall length: 133mm.		
AH4385T	<b>Maloney Quick-Chop</b>	
<b>Nagahara Fine Chopper and Nichamin Quick Chopper</b>		
Double-ended, 10mm from bend to tips, wedge-shaped cutting edge, fine interior cutting edge, blunt tip. Left-hand use, round handle. Overall length: 140mm.		
AH4182	<b>Nagahara Fine Chopper-Nichamin</b>	
<b>Nagahara Phaco Chopper</b>		
Angled shaft, 45 degrees, 10mm from bend to tip, 1.5mm tip, flat interior cutting edge, 60 degrees. Round handle. Overall length: 114mm.		
AH4240	<b>Stainless Steel Chopper</b> Stainless steel, ambidextrous.	
AH4240TI	<b>Titanium Chopper</b> Titanium, ambidextrous.	
AH4242	<b>Stainless Steel Chopper</b> Stainless steel, right-hand use.	
AH4242T	<b>Titanium Chopper</b> Titanium, right-hand use.	
AH4243	<b>Stainless Steel Chopper</b> Stainless steel, left-hand use.	

CHOPPERS

Item #	Description	Image
<b>Nichamin Double-Ended Nucleus Chopper and Spatula</b>		
Double-ended, wedge-shaped chopper, 0.5mm spatula, blunt tip. Round handle. Overall length: 140mm.		
AH4400	<a href="#">Nichamin Double-Ended Nucleus Chopper and Spatula</a>	
<b>Nichamin Quick Chopper</b>		
Titanium, angled shaft, 10mm from bend to tip, wedge-shaped cutting edge. Round handle. Overall length: 115mm.		
AH4184T1	<a href="#">Nichamin Quick Chopper, Left</a> Left-hand use.	
AH4185T	<a href="#">Nichamin Quick Chopper, Right</a> Right-hand use.	
<b>Nichamin Quick Chopper II</b>		
Vaulted shaft, 10mm from bend to tip, eye-shaped wedged cutting edge, slightly angled tip. Right-hand use, round handle. Overall length: 114mm.		
AH4184	<a href="#">Nichamin II Quick Chopper, Right</a>	 
<b>Nichamin Triple Chopper</b>		
Angled shaft, 10mm from bend to tip, unique multi-directional cutting edge. Round handle. Overall length: 114mm.		
AH4265	<a href="#">Nichamin Triple Chopper</a>	
<b>Nucleus Chopper and Safety Quick Chopper</b>		
Double-ended, angled shafts. One end is angled 15mm from bend to tip with curved interior cutting edge and 0.5mm olive-shaped tip. One end is angled 10mm from bend to tip with 0.5mm olive-shaped blade and 1.0mm bend. Round handle. Overall length: 138mm.		
AH4171T	<a href="#">Titanium Chopper, Right</a> Titanium, right-hand use.	
AH4345	<a href="#">Stainless Steel Chopper, Right</a> Stainless steel, right-hand use.	
AH4172T	<a href="#">Titanium Chopper, Left</a> Titanium, left-hand use.	
AH4346	<a href="#">Stainless Steel Chopper, Left</a> Stainless steel, left-hand use.	

CHOPPERS

Item #	Description	Image
--------	-------------	-------

**Rosen Chopper**

Angled shaft, 9.0mm from bend to tip, blunt tip, interior cutting edge, wedge-shaped. Round handle. Overall length: 114mm.

AH4170	<b>Stainless Steel Chopper</b> Stainless steel, 45-degree interior cutting edge.
--------	---



AH4170TI	<b>Titanium Chopper</b> Titanium, 45-degree interior cutting edge.
----------	---

AH4180	<b>Stainless Steel Chopper</b> Stainless steel, 60-degree interior cutting edge.
--------	---



AH4180T	<b>Titanium Chopper</b> Titanium, 60-degree interior cutting edge.
---------	---

**Seibel Nucleus Chopper**

Angled shaft, 15mm from bend to tip, curved interior cutting edge, 0.5mm olive-shaped tip. Round handle. Overall length: 117mm.

AH4175	<b>Seibel Nucleus Chopper, Right</b> Right-hand use.
--------	---



AH4176	<b>Seibel Nucleus Chopper, Left</b> Left-hand use.
--------	---



**Seibel Nucleus Chopper and Safety Quick Chopper**

Double-ended, angled shafts, 10mm from bend to tips, 0.5mm olive-shaped tips, one quick-chop tip, one curved interior cutting edge tip. Round handle. Overall length: 140mm.

AH4177	<b>Double-Ended Chopper, Right</b> Right-hand use.
--------	---



AH4178	<b>Double-Ended Chopper, Left</b> Left-hand use.
--------	---



**Seibel Safety Quick Chopper**

Angled shaft, 10mm from bend to tip, 0.5mm olive shaped tip, 1.0mm bend at tip. Left-hand use, round handle. Overall length: 115mm.

AH4179	<b>Seibel Safety Quick Chopper, Left</b>
--------	--



CHOPPERS

Item #	Description	Image
--------	-------------	-------

**Steinert II Nucleus Claw Chopper**

Vaulted shaft, 10mm from bend to tip, J-shaped chopper, cutting edge. Ambidextrous, round handle. Overall length: 118mm.

AH4218	<a href="#">Steinert II Nucleus Claw Chopper</a>
--------	--



**Sweeney Manipulator Cracker**

Angled shaft, 10mm from bend to tip, flat paddle-shaped tip that is spooned out on left side. Round handle. Overall length: 113mm.

AH4126	<a href="#">Stainless Steel Manipulator Cracker</a> Stainless steel.
--------	---

AH4126T	<a href="#">Titanium Manipulator Cracker</a> Titanium.
---------	---



**Verges Phaco Chopper**







Angled shaft, 12mm from bend to tip, semi-curved centered interior cutting edge, 0.4mm olive-shaped tip. Ambidextrous, round handle. Overall length: 112mm.

AH4275	<a href="#">Verges Phaco Chopper</a>
--------	--------------------------------------



# Hooks & Retractors

## HOOKS

Item #	Description	Image
<b>Bonn Iris Hook</b>		
Straight shaft, curved 0.3mm hooked tip. Flat handle. Overall length: 123mm.		
AH2100	<a href="#">Bonn Iris Hook</a>	
<b>Clayman Micro Iris Hook</b>		
Angled shaft, 45-degree, 9mm shaft, 0.3mm hook. Flat handle. Overall length: 105mm.		
AH2110	<a href="#">Clayman Iris Hook</a>	
<b>Clayman-Jaffe Lens Manipulating Hook</b>		
Angled shaft, 10mm from bend to tip, 0.15mm diameter blunt tip. Flat handle. Overall length: 115mm.		
AH1100	<a href="#">Clayman-Jaffe Lens Manipulating Hook</a>	
		
<b>Crawford Retrieving Hook</b>		
Straight shaft, hooked tip. Round handle. Overall length: 143mm.		
AH0905	<a href="#">Crawford Retrieving Hook</a>	
<b>Crawford/Benger Probe Retrieving Hook</b>		
Angled shaft, 10mm from bend to tip, 65mm shaft, used for retrieving the Crawford/Benger intubation probes, flattened J-shaped tip. Round handle. Overall length: 130mm.		
AH7120	<a href="#">Crawford Hook</a>	



HOOKS

Item #	Description	Image
--------	-------------	-------

**Culler Rectus Muscle Hook**

Straight shaft, flattened hook tip, 7mm hook. Flat handle. Overall length: 125mm.

AH0605	<a href="#">Culler Rectus Muscle Hook</a>
--------	---



**Double Fixation Hook**

Straight shaft, double prong hooked tip, sharp tips. Flat handle. Overall length: 128mm.

AH0530	<a href="#">1.5mm Fixation Hook</a> 1.5mm spread between curved tips.
--------	--

AH0540	<a href="#">2mm Fixation Hook</a> 2mm spread between curved tips.
--------	--



**Fukasaku Snapper Hook**

Angled shaft, 10mm from bend to tip, wedge-shaped flat interior cutting edge, blunt tip, front notch for engaging iris. Round handle. Overall length: 114mm.

AH1600	<a href="#">Fukasaku Snapper Hook</a>
--------	---------------------------------------



**Gass Retinal Detachment Hook**

Straight shaft, Graefe hook tip, 13mm hook, 1.5mm oval hole. Flat handle. Overall length: 143mm.

AH0580	<a href="#">Gass Retinal Detachment Hook</a>
--------	--



**Graether Collar Button-Handle**

Straight and angled shafts. Iris retractor and capsule polisher with roughened posterior surface. Round handle. Overall length: 116mm.

AH2120	<a href="#">Graether Collar Button, Angled</a> Angled shaft, 10mm from bend to tip.
--------	--



HOOKS

Item #	Description	Image
AH2130	<b>Graether Collar Button, Straight</b> Straight shaft.	
		

**Hirschman Iris Hook**

Angled shaft, 45 degree, 9mm from bend to tip, H-shaped 0.75mm hook tip. Round handle. Overall length: 122mm.

AH2140	<b>Hirschman Iris Hook</b>	
		



**Iris Hook**

Straight shaft, blunt curved hook. Flat handle. Overall length: 125mm.

AH2150	<b>Iris Hook</b>	
		



**Jaffe Iris Hook**

Straight shaft, 1.2mm hooked tip, blunt. Flat handle. Overall length: 127mm.







AH2160	<b>Jaffe Iris Hook</b>	
		

**Jaffe Lens Manipulating Hook**





Straight shaft, blunt tip, 0.15mm diameter tip. Flat handle. Overall length: 121mm.

AH1130	<b>Jaffe Lens Manipulating Hook</b>	
		

HOOKS

Item #	Description	Image
<b>Jaffe-Maltzman Lens Manipulating Hook</b>		
Angled shaft, 10mm from bend to tip, 0.15mm V-shaped tip. Flat handle. Overall length: 118mm.		
AH0600	<a href="#">Jaffe-Maltzman Lens Hook</a>	
<b>Kirby Expressor Double-Ended Hook and Loop</b>		
Double-ended, straight shafts, curved 5mm x 10mm loop, smooth loop, 10mm wide muscle/expressor hook. Round handle. Overall length: 155mm.		
AH3160	<a href="#">Kirby Expressor Double-Ended Hook and Loop</a>	
<b>Kuglen Iris Hook Lens Manipulator</b>		
Straight and angled shafts with either K-hook or push-pull type tips. Round or flat handle options. Overall length: 115mm.		
AH0630	<a href="#">Iris Hook and Lens Manipulator, Angled</a> Angled shaft, push-pull tip, 10mm from bend to tip. Flat handle.	
AH0630TI	<a href="#">Iris Hook and Lens Manipulator, Angled</a> Titanium, angled shaft, 10mm from bend to tip, push-pull tip. Round handle.	
AH0630T	<a href="#">Iris Hook and Lens Manipulator, Angled</a> Titanium, angled shaft, 10mm from bend to tip, push-pull tip. Flat handle.	
AH0640	<a href="#">Iris Hook and Lens Manipulator, Straight</a> Straight shaft, push-pull tip. Flat handle.	

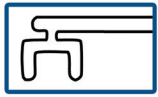
HOOKS

Item #	Description	Image
AH0650	<b>Iris Hook and Lens Manipulator, Straight</b> Straight shaft, push-pull tip. Round handle.	
AH0660	<b>Iris Hook and Lens Manipulator, Angled</b> Angled shaft, 10mm from bend to tip, push-pull tip. Round handle.	
AH0670	<b>Iris Hook and Lens Manipulator, Straight</b> Straight shaft, 0.5mm K-hook. Flat handle.	
AH0675T	<b>Iris Hook and Lens Manipulator, Angled</b> Titanium, angled shaft, 10mm from bend to tip, push-pull tip. Round handle.	

**Maumenee Iris Hook**

Straight shaft, curved hook tip. 1mm blunt tip. Flat handle. Overall length: 121mm.

AH2190	<b>Maumenee Iris Hook</b>	
--------	---------------------------	--

**Shepard Iris Hook**

Straight shaft, 1mm hooked tip, 1 blunt prong, small. Flat handle. Overall length: 127mm.

AH2230	<b>Shepard Iris Hook</b>	
--------	--------------------------	--

HOOKS

Item #	Description	Image
--------	-------------	-------

**Sinskey Iris and IOL Hook**

Straight shaft, 0.2mm hooked tip. Flat serrated handle. Overall length: 118mm.

AH1180	<a href="#">Sinskey Iris and IOL Hook</a>	



**Smith Expressor Hook**

Straight shaft, curved 11.5mm hooked tip. Flat handle. Overall length: 150mm.

AH6950	<a href="#">Smith Expressor Hook</a>	



**Stevens Tenotomy Hook**

Straight shaft, 6mm hook shaped tip, blunt. Flat handle. Overall length: 120mm.

AH0750	<a href="#">Stevens Tenotomy Hook</a>	



**Twist Fixation Hook**

Straight shaft, clockwise and counter-clockwise twist hooks. Round handle.

AH0760	<a href="#">Twist Fixation Hook, 0.3mm</a>	
	Small, 0.3mm, left, counter-clockwise twist hook. Overall length: 110mm.	
AH0770	<a href="#">Twist Fixation Hook, 0.3mm</a>	
	Small, 0.3mm, right, clockwise twist hook. Overall length: 110mm.	
AH0780	<a href="#">Twist Fixation Hook, 0.5mm</a>	





AH0770	<a href="#">Twist Fixation Hook, 0.3mm</a>
	Small, 0.3mm, right, clockwise twist hook. Overall length: 110mm.



AH0780	<a href="#">Twist Fixation Hook, 0.5mm</a>
	Large, 0.5mm, left, counter-clockwise twist hook. Overall length: 127mm.



AH0790	<a href="#">Twist Fixation Hook, 0.5mm</a>
	Large, 0.5mm, right, clockwise twist hook. Overall length: 127mm.

## HOOKS



Item #	Description	Image
<b>Tyrell Iris Hook</b>		
Straight shaft, 2mm hooked tip, 1 sharp prong. Flat handle. Overall length: 127mm.		
AH2240	<a href="#">Tyrell Iris Hook</a>	
<b>University of Kansas Spatula and Hook</b>		
Double-ended, 2mm wide x 24mm long spatula tip, malleable, 3mm wide hooked tip, 90 degree angle. Flat handle. Overall length: 124mm.		
AH5360	<a href="#">University of Kansas Spatula and Hook</a>	
<b>Green Strabismus Hook</b>		
Straight shaft, 7mm wide tip, flat-ended hook tip. Flat handle. Overall length: 130mm.		
AH0590	<a href="#">Green Strabismus Hook</a>	
<b>Jameson Muscle Hook</b>		
Straight shaft, 6mm flat hook with bulbous tip. Flat handle. Overall length: 133mm.		
AH0610	<a href="#">2mm Muscle Hook</a> 2mm bulbous tip.	
AH0620	<a href="#">1.5mm Muscle Hook</a> 1.5mm bulbous tip.	
<b>Von Graefe Strabismus Hook</b>		
Straight shaft, flattened hook tip. Flat handle.		
AH0800	<a href="#">Von Graefe Strabismus Hook, Size 1</a> 8mm from hook bend to tip. Overall length: 140mm.	



HOOKS

Item #	Description	Image
AH0810	<p><b>Von Graefe Strabismus Hook, Size 2</b></p> <p>9mm from hook bend to tip. Overall length: 140mm.</p>	
AH0820	<p><b>Von Graefe Strabismus Hook, Size 3</b></p> <p>10mm from hook bend to tip. Overall length: 143mm.</p>	

RETRACTORS

Item #	Description	Image
<p><b>Berke-Jaeger Lid Plate</b></p> <p>Double-ended stainless steel lid plate, flat with rounded ends, 20mm and 23mm wide blades. Overall length: 109mm.</p>		
AL2110	<p><b>Berke-Jaeger Lid Plate</b></p>	
<p><b>Conway Lid Retractor</b></p> <p>7.5mm wide blade, flat handle. Overall length: 142mm.</p>		
AL2155	<p><b>Conway Lid Retractor</b></p>	
<p><b>Desmarres Lid Retractor</b></p> <p>Wide retractor blade. Flat, serrated handle with polished finish.</p>		
AL2120	<p><b>Desmarres Lid Retractor, Size 0</b></p> <p>11mm wide retractor blade. Overall length: 140mm.</p>	
AL2130	<p><b>Desmarres Lid Retractor, Size 1</b></p> <p>13mm wide retractor blade. Overall length: 137mm.</p>	
AL2140	<p><b>Desmarres Lid Retractor, Size 2</b></p> <p>15mm wide retractor blade. Overall length: 143mm.</p>	
AL2150	<p><b>Desmarres Lid Retractor, Size 3</b></p> <p>17mm wide retractor blade. Overall length: 145mm.</p>	

RETRACTORS

Item #	Description	Image
--------	-------------	-------

**Knapp Lacrimal Sac Retractor**

Blunt 4mm x 8mm wide 4-prong tip. Flat serrated handle with polished finish. Overall length: 135mm.

AL2180 [Knapp Lacrimal Retractor](#)

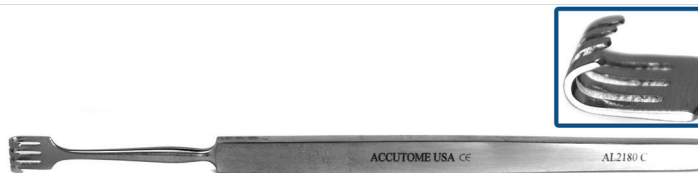

**Pupil Iris Retractor**

4-prong, intraocular handle, curved.

AL3300 [Pupil Iris Retractor](#)



**Rizzuti Expressor and Iris Retractor**

Double-ended, small retractor blade, 2.5mm wide, muscle hook/lens expressor tip. Round handle. Overall length: 147mm.

AH2210 [Rizzuti Expressor and Iris Retractor](#)



**Schepens Orbital Retractor**

Smooth 14mm x 56mm blade with 4.5mm wide notch in blade. Flat serrated handle. Overall length: 148mm.

AL2210 [Schepens Orbital Retractor](#)



# DSEK Instruments

## DSEK

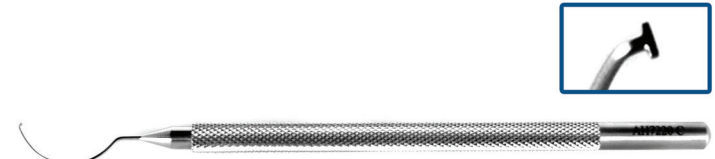
Item #	Description	Image
<b>Carlson DSEK Smoother</b>		
Angled shaft, 7.5mm from bend to tip, 2.5mm ball tip. Round handle. Overall length: 115mm.		
AH7200	<a href="#">DSEK Smoother</a>	
<b>Descemet's DSEK/DSAEK Stripper</b>		
Strongly curved shaft, 15mm from bend to tip, T-shaped tip, 0.75mm in diameter. Round handle. Overall length: 114mm.		
AH7220	<a href="#">DSEK/DSAEK Stripper</a>	
<b>Rosenwasser Endothelial Stripper</b>		
The Rosenwasser Endothelial Stripper, also known as Melles DSAEK PLK Scraper Style 2, has an angled shaft, 11mm from bend to tip, angled 45 degrees and 90-degree angled sandblasted tip. Round handle. Overall length: 125mm.		
AH7202	<a href="#">Rosenwasser Endothelial Stripper</a>	

# Fixation Rings & Picks

FIXATION RINGS

Item #	Description	Image
<b>Fine-Thornton Fixation Ring</b>		
Swivel style, open ring, with various degree markings on top of ring. Round, knurled handle. Overall length: 133mm.		
AR0190	<b>13mm Fixation Ring</b> 13mm diameter ring with 10-degree markings on top.	
AR0190TI	<b>13mm Fixation Ring</b> Titanium. 13mm diameter ring with 10-degree markings on top.	
AR0191	<b>13mm Fixation Ring</b> 13mm diameter ring with 15-degree markings on top.	
AR0197	<b>14mm Fixation Ring</b> 14mm diameter ring with 10-degree markings on top.	
AR0200	<b>16mm Fixation Ring</b> 16mm diameter ring with 10-degree markings on top.	

**Flieringa Scleral Fixation Ring**

Flieringa Scleral Fixation Rings are stainless steel with a polished finish. Various sizes ranging from 12mm to 23mm. Sets are available.

AM0330 12	<b>12mm Scleral Fixation Ring</b> Stainless steel scleral fixation ring set. 12mm in diameter.	
AM0330 13	<b>13mm Scleral Fixation Ring</b> Stainless steel scleral fixation ring set. 13mm in diameter.	
AM0330 14	<b>14mm Scleral Fixation Ring</b> Stainless steel scleral fixation ring set. 14mm in diameter.	
AM0330 15	<b>15mm Scleral Fixation Ring</b> Stainless steel scleral fixation ring set. 15mm in diameter.	
AM0330 16	<b>16mm Scleral Fixation Ring</b> Stainless steel scleral fixation ring set. 16mm in diameter.	
AM0330 17	<b>17mm Scleral Fixation Ring</b> Stainless steel scleral fixation ring set. 17mm in diameter.	
AM0330 18	<b>18mm Scleral Fixation Ring</b> Stainless steel scleral fixation ring set. 18mm in diameter.	
AM0330 19	<b>19mm Scleral Fixation Ring</b> Stainless steel scleral fixation ring set. 19mm in diameter.	
AM0330 20	<b>20mm Scleral Fixation Ring</b> Stainless steel scleral fixation ring set. 20mm in diameter.	
AM0330 21	<b>21mm Scleral Fixation Ring</b> Stainless steel scleral fixation ring set. 21mm in diameter.	
AM0330 22	<b>22mm Scleral Fixation Ring</b> Stainless steel scleral fixation ring set. 22mm in diameter.	
AM0330 23	<b>23mm Scleral Fixation Ring</b> Stainless steel scleral fixation ring set. 23mm in diameter.	
AM0330	<b>Set of 8 Scleral Fixation Rings</b> Stainless steel scleral fixation ring set. This set includes 8 different sized rings that increase in 1.0mm increments. Diameter sizes include: 16mm, 17mm, 18mm, 19mm, 20mm, 21mm, 22mm, and 23mm.	



FIXATION RINGS

Item #	Description	Image
AM0330 SET	<p><b>Set of 12 Scleral Fixation Rings</b></p> <p>Stainless steel scleral fixation ring set. This set includes 12 different sized rings that increase in 1.0mm increments. Diameter sizes include: 12mm, 13mm, 14mm, 15mm 16mm, 17mm, 18mm, 19mm, 20mm, 21mm, 22mm, and 23mm.</p>	

**Globe Fixation Ring**

Fixed style, open ring. 16mm diameter. Concentric grooves on the bottom of ring for fixation of globe. Round handle. Overall length: 133mm.

AR0395	<b>Globe Fixation Ring</b>	
--------	----------------------------	--

**Thornton Fixation Ring**



Fixed style. Overall length: 133mm.

AR0430	<p><b>Thornton Fixation Ring, Open</b></p> <p>Open ring. 13mm diameter with 7mm opening. Flat handle.</p>	
--------	---	---



AR0420	<p><b>Thornton Fixation Ring, Closed</b></p> <p>Closed ring. 16mm diameter. Round handle.</p>	
--------	---	--

FIXATION PICKS

Item #	Description	Image
<p><b>Anis Scleral Twist Fixation Cone</b></p> <p>Straight shaft, cone with 2.5mm diameter. Round handle.</p>		

AH0510	<b>Anis Scleral Twist Fixation Cone</b>	 
--------	---	--

## FIXATION PICKS

Item #	Description	Image
<b>Burch Fixation Pick</b>	Straight shaft, dual pronged tips, sharp tipped, 3.0mm apart. Flat handle. Overall length: 131mm.	
AH0520	<a href="#">Burch Fixation Pick</a>	

# Forceps & Clamps

CAPSULE FORCEPS

Item #	Description	Image
--------	-------------	-------

**Arruga Capsule Forceps**

Vaulted shafts, narrow cup jaws. Flat handle. Overall length: 101mm.

AF0215	<a href="#">Arruga Capsule Forceps, Curved</a> 2.0mm cup jaws.
--------	---

AF0210	<a href="#">Arruga Capsule Forceps, Curved</a> 2.5mm cup jaws.
--------	---



**Castroviejo Capsule Forceps**

Vaulted, cross-action shafts with 2.5mm cup jaws. Flat handle. Overall length: 105mm.

AF0230	<a href="#">Castroviejo Capsule Forceps</a>
--------	---



**Gaskin Fragment Forceps**

Angled shafts, 11mm from bend to tip, smooth jaws. Flat handle. Overall length: 108mm.

AF6395	<a href="#">Gaskin Fragment Forceps</a>
--------	---



**Kraff Capsule Tag Forceps**

Angled shafts, 11mm long jaws with 1.5mm smooth platform. Flat, 3-hole handle. Overall length: 108mm.

AF0250	<a href="#">Kraff Capsule Tag Forceps</a>
--------	---



**CAPSULORHEXIS FORCEPS**

Item #	Description	Image
--------	-------------	-------

**Devgan MICS Capsulorhexis Forceps**

Vaulted cross-action shafts. Marks on top of shafts at 2.5mm and 5mm. Very fine Utrata style tips. Round handle. Overall length: 119mm.

AF0365T [Devgan MICS Capsulorhexis Forceps](#)



**Gianetti MICS Capsulorhexis Forceps**

Vaulted thin shafts, 1.5mm maximum tip spread, extremely small delicate tips. Round handle. Overall length: 101mm.

AF0292 [Gianetti MICS Capsulorhexis Forceps](#)



**Gimbel Capsulorhexis Forceps**

Angled shafts, 12mm from bend to tip. Fine, serrated grasping tips, jaws set to open only 3mm. Light tension. Flat handle. Overall length: 80mm.

AF0295 [Gimbel Capsulorhexis Forceps](#)



**Kellan Capsulorhexis Forceps**

Angled shafts, 11mm from bend to tip at 45 Degrees with Arruga style tips. Round knurled handle with guide pin. Overall length: 100mm.

AF0288 [Kellan Capsulorhexis Forceps](#)









**Lehner-Utrata Capsulorhexis Forceps**

Vaulted shafts, 12mm from bend to tip, delicate grasping tips. Flat handle. Overall length: 82mm.

AF0300 C [Lehner-Utrata Capsulorhexis Forceps](#)

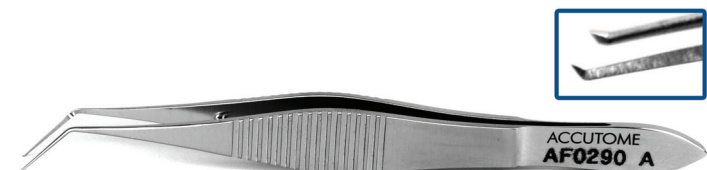

CAPSULORHEXIS FORCEPS



Item #	Description	Image
<b>Masket Capsulorhexis Forceps</b>		
Vaulted 11mm shafts, very delicate triangular tips for grasping capsule. Flat handle. Overall length: 101mm.		
AF0340	<a href="#">Masket Capsulorhexis Forceps</a>	
<b>Nevyas Capsulorhexis Forceps</b>		
Angled shafts, 12mm from bend to tip. Cystotome shaped tip for puncturing capsule. Flat handle. Overall length: 104mm.		
AF0530	<a href="#">Nevyas Capsulorhexis Forceps</a>	
<b>O'Gawa-Utrata Capsulorhexis Forceps</b>		
Angled shafts, 12mm from bend to tip. Fine, serrated tips for grasping capsule. Round handle. Overall length: 98mm.		
AF0355	<a href="#">O'Gawa-Utrata Capsulorhexis Forceps</a>	
<b>Utrata Capsulorhexis Forceps</b>		
Angled and vaulted shafts, serrated and triangular tips for grasping capsule.		
AF0290	<a href="#">Utrata Capsulorhexis Forceps, Angled</a> Angled shafts, 12mm bend from tip. Fine, serrated tips for grasping capsule. Flat handle. Overall length: 82mm.	
AF0290 A	<a href="#">Utrata Capsulorhexis Forceps, Angled</a> Angled shafts, 12mm bend from tip. Fine, serrated tips for grasping capsule. Flat handle. Overall length: 80mm.	
AF0290K	<a href="#">Utrata Capsulorhexis Forceps, Angled</a> Angled shafts, 12mm bend from tip. Fine, serrated tips for grasping capsule. Flat, 3-hole handle. Overall length: 82mm.	





CAPSULORHEXIS FORCEPS

Item #	Description	Image
AF0290TI	<p><b>Utrata Capsulorhexis Forceps, Angled</b></p> <p>Titanium. Angled shafts, 11mm bend from tip. Fine, serrated tips for grasping capsule. Flat handle. Overall length: 82mm.</p>	 <p>The image shows a pair of blue titanium forceps with angled shafts and serrated tips. A small inset shows a close-up of the tips. The handle is flat and has the model number AF0290TI CE printed on it.</p>
AF0299	<p><b>Utrata Capsulorhexis Forceps, Angled</b></p> <p>Angled shafts, 12mm bend from tip. Fine, sharp serrated tips for grasping capsule. Flat handle. Overall length 82mm.</p>	 <p>The image shows a pair of silver forceps with angled shafts and serrated tips. A small inset shows a close-up of the tips. The handle is flat and has the model number AF0299 CE printed on it.</p>
AF0300	<p><b>Utrata Capsulorhexis Forceps, Angled</b></p> <p>Angled shafts, 12mm bend from tip. Fine, serrated tips for grasping capsule. Round handle. Overall length: 98mm.</p>	 <p>The image shows a pair of silver forceps with angled shafts and serrated tips. A small inset shows a close-up of the tips. The handle is round and has the model number AF0300 CE printed on it.</p>
AF0300TI	<p><b>Utrata Capsulorhexis Forceps, Angled</b></p> <p>Titanium. Angled shafts, 12mm bend from tip. Fine, serrated tips for grasping capsule. Round handle. Overall length: 98mm.</p>	 <p>The image shows a pair of blue titanium forceps with angled shafts and serrated tips. A small inset shows a close-up of the tips. The handle is round and has the model number AF0300TI CE printed on it.</p>
AF0310	<p><b>Utrata Capsulorhexis Forceps, Vaulted</b></p> <p>Vaulted shafts. Fine, serrated tips for grasping capsule. Round handle. Overall length: 98mm.</p>	 <p>The image shows a pair of silver forceps with vaulted shafts and serrated tips. A small inset shows a close-up of the tips. The handle is round and has the text ACCUTOME USA CE printed on it.</p>
AF0310TI	<p><b>Utrata Capsulorhexis Forceps, Vaulted</b></p> <p>Titanium. Vaulted shafts. Fine, serrated tips for grasping capsule. Round handle. Overall length: 98mm.</p>	 <p>The image shows a pair of blue titanium forceps with vaulted shafts and serrated tips. A small inset shows a close-up of the tips. The handle is round and has the model number AF0310TI CE printed on it.</p>
AF0350	<p><b>Utrata Capsulorhexis Forceps, Vaulted</b></p> <p>Vaulted shafts, 12mm bend from tip. Fine, serrated tips for grasping capsule. Cross-action handle. Overall length: 116mm.</p>	 <p>The image shows a pair of silver forceps with vaulted shafts and serrated tips. A small inset shows a close-up of the tips. The handle is a cross-action design and has the model number AF0350 CE printed on it.</p>
AF0290K T	<p><b>Utrata Capsulorhexis Forceps, Angled</b></p> <p>Titanium. Angled shafts, 12mm bend from tip. Fine, serrated tips for grasping capsule. Flat, 3-hole handle. Overall length: 101mm.</p>	 <p>The image shows a pair of blue titanium forceps with angled shafts and serrated tips. A small inset shows a close-up of the tips. The handle is flat and has three circular holes. The model number AF0290K T CE is printed on the handle.</p>

CAPSULORHEXIS FORCEPS

Item #	Description	Image
AF0290L	<p><b>Utrata Capsulorhexis Forceps, Angled</b></p> <p>Angled shafts, 12mm from bend to tip, delicate, triangular tips, laser marks on shaft at 2.5mm and 5.0mm. Short, flat 3-hole handle. Overall length: 89mm.</p>	
<p><b>Utrata MICS Capsulorhexis Forceps</b></p> <p>Angled shafts, 12mm from bend to tip. Fine, serrated tips for grasping capsule. 1.8mm maximum blade spread. Flat handle. Overall length: 81mm.</p>		
AF0290M	<p><b>Stainless Steel Capsulorhexis Forceps</b></p> <p>Stainless steel.</p>	
AF0290M T	<p><b>Titanium Capsulorhexis Forceps</b></p> <p>Titanium.</p>	

CHALAZION FORCEPS

Item #	Description	Image
<p><b>Baird Chalazion Forceps</b></p> <p>Oval 13mm solid lower plate, 12mm x 8mm open upper plate, locking thumb screw. Flat handle. Overall length: 97mm.</p>		
AF0400	<p><b>Baird Chalazion Forceps</b></p>	
<p><b>Desmarres Chalazion Forceps</b></p> <p>Solid lower plate with open upper plate, locking thumb screw. Flat handle. Overall length: 89mm.</p>		
AF0410	<p><b>Desmarres Chalazion Forceps, 24mm</b></p> <p>24mm solid lower plate, 12mm x 17mm open upper plate.</p>	
AF0411	<p><b>Desmarres Chalazion Forceps, 30mm</b></p> <p>30mm solid lower plate, 12mm x 20mm open upper plate.</p>	
<p><b>Francis Chalazion Forceps</b></p> <p>17mm lower plate, 12mm x 14mm upper plate, cross-action flat handle. Overall length: 98mm.</p>		
AF0430	<p><b>Francis Chalazion Forceps</b></p>	

CHALAZION FORCEPS

Item #	Description	Image
--------	-------------	-------

**Heath Chalazion Forceps**

Solid oval lower plate, 12mm x 14mm open upper plate, locking thumb screw. Flat handle. Overall length: 98mm.

AF0440	<a href="#">Heath Chalazion Forceps</a>	
--------	---	--



**Hunt Chalazion Forceps**

Solid round lower plate, 12mm open upper plate, locking thumb screw, flat handle. Overall length: 98mm.

AF0450	<a href="#">Hunt Chalazion Forceps</a>	
--------	--	--



**Lambert Chalazion Forceps**

Solid round lower plate, open upper plate, locking thumb screw. Flat handle. Overall length: 92mm.

AF0460	<a href="#">Lambert Chalazion Forceps, Large</a>	
	Large, solid round lower plate, 15mm open upper plate.	



AF0470	<a href="#">Lambert Chalazion Forceps, Small</a>	
	Small, solid round lower plate, 8.0mm open upper plate.	



**Wies Chalazion Forceps**

15mm solid lower plate with 9mm x 12mm open serrated upper plate, locking thumb screw, flat handle.

AF0520	<a href="#">Wies Chalazion Forceps</a>	
--------	--	--



CILIA FORCEPS

Item #	Description	Image
--------	-------------	-------

**Barraquer Cilia Forceps**

Slightly angled shafts, 6mm smooth platform tips. Overall length: 111mm.

AF0800	<b>Flat Handle Forceps</b> Flat handle.
--------	--



AF0801	<b>3-Hole Handle Forceps</b> Flat, 3-hole handle.
--------	--



**Cilia Forceps**

Straight shafts, 1.0mm x 3.0mm smooth platform tips. Flat handle. Overall length: 75mm.

AF0810	<b>Cilia Forceps</b>
--------	----------------------



**Drews Cilia Forceps**

Straight, narrow shafts with 7mm long smooth platform. Flat handle. Overall length: 105mm.

AF0820	<b>Drews Cilia Forceps</b>
--------	----------------------------



**Gradle Cilia Forceps**

Straight shafts, 2mm fine tips. Flat, cross-action handle. Overall length: 95mm.



AF0830	<b>Gradle Cilia Forceps</b>
--------	-----------------------------



CILIA FORCEPS

Item #	Description	Image
<b>Swiss Cilia and Suture Forceps</b>		
Straight shafts, 45-degree 3mm wide jaws. Flat handle. Overall length: 95mm.		
AF0840	<b>Swiss Cilia and Suture Forceps</b>	

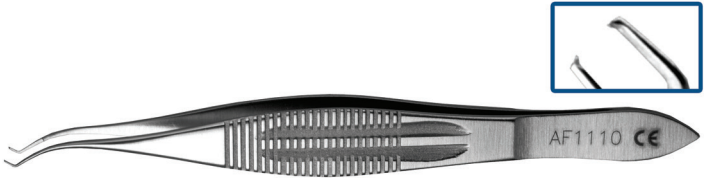
CORNEAL FORCEPS

Item #	Description	Image
<b>Castroviejo Colibri Corneal Forceps</b>		
Curved shafts, 0.12mm 1 x 2 teeth set at 45 degrees, 6mm tying platform. Flat, wide handle. Overall length: 108mm.		
AF1110	<b>Stainless Steel Forceps</b> Stainless steel.	
AF1110T	<b>Titanium Forceps</b> Titanium.	

Girard Corneoscleral Forceps

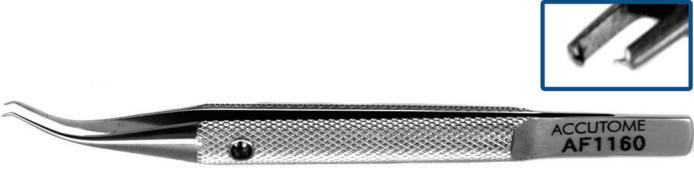
Curved shafts, 1 x 2 teeth set at 90 degrees, 6mm tying platform. Round handle. Overall length: 108mm.		
AF1150	<b>Scleral Forceps, Right</b> Right-hand use, 0.12mm tip.	
AF1160	<b>Scleral Forceps, Left</b> Left-hand use, 0.12mm tip.	
AF1170	<b>Scleral Forceps, Left</b> Left-hand use, 0.3mm tip.	



CORNEAL FORCEPS

Item #	Description	Image
--------	-------------	-------

**Hyde Corneal Forceps**

Curved shafts, 0.12mm 2 x 2 teeth set at 45 degrees, 6mm tying platform. Flat handle. Overall length: 108mm.

AF1190 [Hyde Corneal Forceps](#)



**Katzin-Barraquer Colibri Corneal Utility Forceps**

Colibri style. 0.4mm 1 x 2 teeth set at 90 degrees, with 6mm tying platform. Overall length: 73mm.

AF1185 [Corneal Utility Forceps](#)

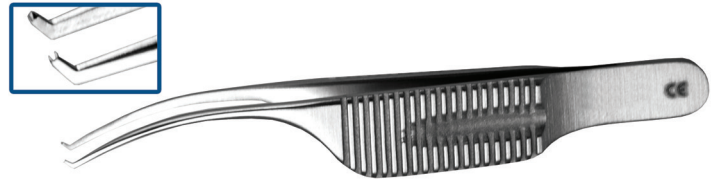

**Pierse Colibri Corneal Forceps**

Very delicate 0.11mm 1 x 1 Pierse-type teeth, flat handle. Overall length: 76mm.

AF1240 [Pierse Colibri Corneal Forceps](#)



**Polack Colibri Corneal Forceps**

Colibri style. Double 0.12mm 1 x 2 teeth separated by 1.0mm and 2.75mm long. Overall length: 70mm.

AF1250 [Polack Colibri Corneal Forceps](#)



**Thorpe Corneal Forceps**

Straight shafts, 0.12mm 2 x 3 teeth set at 45 degrees, with 5mm tying platform. Flat handle. Overall length: 94mm.

AF1270 [Thorpe Corneal Forceps](#)





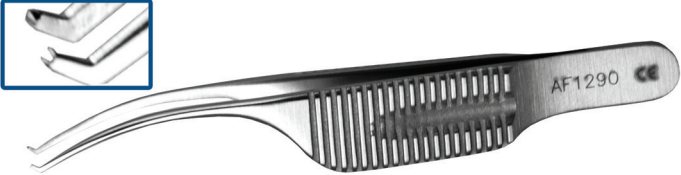

**CORNEAL FORCEPS**

Item #	Description	Image
<b>Troutman-Barraquer Colibri Corneal Forceps</b>		
Colibri style corneal forceps that are available in both stainless steel and titanium options. Forceps have curved shafts and various tip sizes with 1 x 2 teeth sets. Flat handle. Overall length: 76mm.		
AFI295	<b>0.3mm Corneal Forceps</b> 0.3mm teeth set at 90 degrees, 6mm tying platform.	
AFI280	<b>0.5mm Corneal Forceps</b> 0.5mm teeth set at 45 degrees.	
AFI180	<b>0.12mm Corneal Forceps</b> 0.12mm teeth set at 45 degrees, 4.5mm tying platform.	
AFI180TI	<b>0.12mm Titanium Corneal Forceps</b> Titanium, 0.12mm teeth set at 45 degrees, 4.5mm tying platform.	
AFI290	<b>0.12mm Corneal Forceps</b> 0.12mm set at 90 degrees.	
AFI290TI	<b>0.12mm Titanium Corneal Forceps</b> Titanium. 0.12mm teeth set at 90 degrees.	

**DSEK FORCEPS**

Item #	Description	Image
<b>Charlie II Donor Forceps</b>		
Titanium. Very delicate, angled shafts, extremely thin semi-pointed tips. When tips are closed, there is a 150 micron (0.15mm) gap to keep from cell damage. Round knurled handle with guide pin. Overall length: 105mm.		
AF0285T	<b>Charlie Donor Forceps</b>	
<b>Rossenwasser Donor Lamella Forceps</b>		
Angled/vaulted shafts, 12mm from bend to tip with 2mm thin semi-pointed tips. When tips are closed there is a 150 micron (0.15mm) gap to keep from cell damage. Flat, 3-hole handle. Overall length: 102mm.		
AF0286	<b>Rossenwasser Donor Lamella</b>	





DSEK FORCEPS

Item #	Description	Image
<b>Snyder Stripping Forceps</b>		
Angled shafts, 12mm from bend to tip. Tips pointed upward for grasping of Descemet's Membrane. Flat handle. Overall length: 83mm.		
AF0291	<b>Stripping Forceps</b>	

DRESSING FORCEPS

Item #	Description	Image
<b>Bishop-Harmon Dressing Forceps</b>		
Straight shafts, 0.6mm cross-serrated tips. Flat, 3-hole handle. Overall length: 82mm.		
AF2100	<b>Bishop-Harmon Dressing Forceps</b>	

Dressing Forceps

Straight and curved shafts, 11mm serrated tips. Flat handle. Overall length: 98mm.		
AF2110	<b>Dressing Forceps, Curved</b> Heavy, slightly curved shafts.	
AF2120	<b>Dressing Forceps, Curved</b> Delicate, strong curved shafts.	
AF2140	<b>Dressing Forceps, Straight</b> Delicate, straight shafts.	
AF2130	<b>Dressing Forceps, Curved</b> Delicate, slightly curved shafts.	

**DRESSING FORCEPS**

Item #	Description	Image
AF2150	<b>Dressing Forceps, Straight</b> Heavy, straight shafts.	

**FEMTOSECOND FORCEPS**

Item #	Description	Image
<b>Femto LRI Enhancement Forceps</b>		
Cross-action handle with 1.0mm paddles designed to open femtosecond cataract incisions.		
AF6178	<b>Femto LRI Enhancement Forceps</b>	

**FIXATION FORCEPS**

Item #	Description	Image
<b>Castroviejo Fixation Forceps</b>		
Straight shafts, 0.3mm 1 x 2 teeth, without platforms, wide serrated flat handle. Overall length: 111mm.		
AF2320	<b>Castroviejo Fixation Forceps</b>	

<b>Fechtner Conjunctiva Forceps</b>		
Straight shafts, delicate ring tips with tying platform. Flat, 3-hole handle. Overall length: 101mm.		
AF1115	<b>Fechtner Conjunctiva Forceps</b>	

FIXATION FORCEPS

Item #	Description	Image
--------	-------------	-------

**Graefe Fixation Forceps**

Straight shafts, jaws with fine teeth. Flat handle. Overall length: 111mm.

AF2360	<b>4.5mm Graefe Fixation Forceps</b> 4.5mm wide jaws.
--------	--

AF2370	<b>3.5mm Graefe Fixation Forceps</b> 3.5mm wide jaws.
--------	--

AF2380	<b>4.5mm Graefe Fixation Forceps</b> 4.5mm wide jaws, fine teeth with lock.
--------	--



**Green Fixation Forceps**

Straight shafts, 10mm wide jaws with teeth. Flat handle. Overall length: 98mm.

AF2395	<b>Green Fixation Forceps</b>
--------	-------------------------------



**Kremer Corneal Fixation Forceps**

Angled shafts, U-shaped double 0.12mm 1 x 2 teeth, separated 13.0mm, with lock. Flat handle. Overall length: 105mm.

AF2400	<b>Kremer Corneal Fixation Forceps</b>
--------	--



**Lester Fixation Forceps**

Straight shafts, fine 2 x 3 teeth set at 90 degrees, flat handle. Overall length: 95mm.

AF2440	<b>Lester Fixation Forceps</b>
--------	--------------------------------



**McGregor Conjunctiva Forceps**

Straight shafts, 6mm tying platform. Flat handle: Overall length: 108mm.

AF6950	<b>McGregor Conjunctiva Forceps</b>
--------	-------------------------------------



**FIXATION FORCEPS**

Item #	Description	Image
<b>Moody Fixation Forceps</b>		
Curved, 0.5mm 1 x 2 teeth, with lock. Flat handle. Overall length: 86mm.		
AF2450	<b>Fixation Forceps, Left</b> Curved left.	
AF2451	<b>Fixation Forceps, Right</b> Curved right.	



<b>Osher Fixation Forceps</b>		
0.12mm Elschmig 1 x 2 teeth, delicate tying platform, wide serrated flat handle. Overall length: 105mm.		
AF0600	<b>Osher Fixation Forceps</b>	

<b>Thorpe Conjunctiva Forceps</b>		
Straight shafts, 2 x 3 teeth set at 90 degrees and tying platform. Flat handle: Overall length: 94mm.		
AF2540	<b>Thorpe Conjunctiva Forceps</b>	

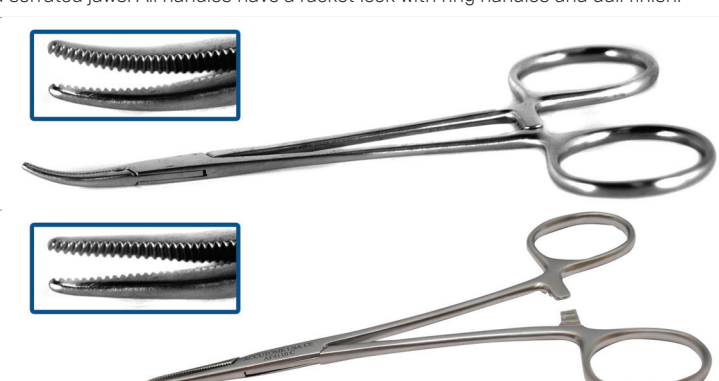
**HEMOSTATIC FORCEPS**

Item #	Description	Image
<b>Hemostatic Forceps</b>		
Stainless steel hemostatic forceps that are available with both straight and curved serrated jaws. All handles have a ratchet lock with ring handles and dull finish.		
AF4100	<b>Curved Hemostatic Forceps</b> Curved, 22mm serrated jaws. Overall length: 99mm.	
AF4110	<b>Straight Hemostatic Forceps</b> Straight, 22mm serrated jaws. Overall length: 127mm.	

HEMOSTATIC FORCEPS

Item #	Description	Image
AF4120	<b>Curved Hemostatic Forceps</b> Curved, 20mm serrated jaws. Overall length: 99mm.	
AF4130	<b>Straight Hemostatic Forceps</b> Straight, 20mm serrated jaws. Overall length: 99mm.	

**Kelly Hemostatic Forceps**

Straight and curved shafts with serrated jaws. Ring handle. Overall length: 140mm.

AF0700	<b>Kelly Forceps, Straight</b> Straight shafts.	
--------	--	---

AF0750	<b>Kelly Forceps, Curved</b> Curved shafts.	
--------	--	--

**Sponge Forceps**

Straight shafts, serrated jaws. Ring handle. Overall length: 178mm.

AF9075	<b>Sponge Forceps</b>	
--------	-----------------------	--



IOL FORCEPS

Item #	Description	Image
--------	-------------	-------

**Accutome Folding Forceps**

Angled, cross-action shafts. Cradle jaws. Flat handle. Overall length: 97mm.

AF2405 [Accutome Folding Forceps](#)



**Faulkner Lens Holding Forceps**

Angled shafts, round smooth polished jaws. Flat, 3-hole handle. Overall length: 114mm.

AF3150 [Faulkner Lens Holding Forceps](#)



**Haberle-McPherson Lens Holding Forceps**

Angled shafts, 7.5mm smooth jaws with diagonal groove in tip. Flat, 3-hole handle.

AF3480 [Haberle-McPherson Lens Holding Forceps](#)



**Implant Removal Forceps**

Angled, cross-action, thin shafts. Tooth in top jaw with grooves in bottom jaw. Designed to grasp the lens optic or lens segment to efficiently remove from the anterior chamber. Overall length: 120mm.

AF3305 [Implant Removal Forceps](#)



**IOL Lens Loading Forceps**

Designed for loading AcrySoft IOL into Monarch II and III Cartridges.

AF8000 [IOL Lens Loading Forceps](#)



IOL FORCEPS

Item #	Description	Image
--------	-------------	-------

**Accutome IOL Lens Loading Forceps**

Straight shafts, with smooth, flat jaws. Flat handle.

AF3345	<a href="#">Accutome IOL Lens Loading Forceps</a>
--------	---



**Livernois IOL Folding Forceps**

Angled shafts, concave jaw surface. Flat, 3-hole handle.

AF3225	<a href="#">Livernois IOL Folding Forceps</a>
--------	---



**Livernois IOL Holding Forceps**

Livernois IOL Holding Forceps are available in both angled and straight shafts. Rounded jaws that are to be used on soft IOLs. Flat, 3-hole handle. Overall length: 108mm.

AF3230	<a href="#">IOL Forceps, Angled</a> Angled shafts.
--------	---



AF3240	<a href="#">IOL Forceps, Straight</a> Straight shafts.
--------	---



**Steinert Folding Forceps**

Angled shafts. Flat handle. Overall length: 108mm.

AF3390	<a href="#">Steinert Folding Forceps</a>
--------	--



IOL FORCEPS

Item #	Description	Image
--------	-------------	-------

**Universal II IOL Insertion Forceps**

Titanium. Cross-action shafts for small incision insertion of second generation foldable IOLs, petite tips, with lock. For thin silicone IOLs.

AF3360 [Universal II IOL Insertion Forceps](#)



**Universal III IOL Insertion Forceps**

Titanium. Cross-action shafts for small incision insertion of third generation foldable IOLs, petite tips, with lock. For thin acrylic IOLs.

AF3370 [Universal III IOL Insertion Forceps](#)



JEWELER FORCEPS

Item #	Description	Image
--------	-------------	-------

**Jeweler Forceps**

Straight, angled, and curved shafts with fine pointed tips. Smooth handle with dull finish.

AF3700 [Jewelers Type Forceps #1](#)  
Straight shafts with fine pointed tips. Overall length: 120mm.



AF3705 [Jewelers Type Forceps #2](#)  
Straight shafts with strong, fine pointed tips. Overall length: 120mm.











AF3710 [Jewelers Type Forceps #3](#)  
Straight shafts with extra fine pointed tips. Overall length: 120mm.



AF3720 [Jewelers Type Forceps #3-C](#)  
Straight shafts with extra fine pointed tips. Overall length: 110mm.



JEWELER FORCEPS

Item #	Description	Image
AF3730	<p><b>Jewelers Type Forceps #4</b></p> <p>Straight and narrow shafts with extra fine pointed tips. Overall length: 110mm.</p>	 
AF3740	<p><b>Jewelers Type Forceps #5/45</b></p> <p>Angled shafts with extra fine pointed tips. Overall length: 120mm.</p>	 
AF3750	<p><b>Jewelers Type Forceps #5</b></p> <p>Straight, narrow shafts with extra fine pointed tips. Overall length: 120mm.</p>	 
AF3760	<p><b>Jewelers Type Forceps #7</b></p> <p>Curved shafts with extra fine pointed tips. Overall length: 111mm.</p>	 

**Suture Removal Forceps**

Slightly angled shafts, very fine pointed tips with textured jaws. Smooth, flat handle with dull finish. For wet suture removal. Overall length: 120mm.



AF3775	<p><b>Suture Removal Forceps</b></p>	
--------	--------------------------------------	--

**Jeweler's Type Utility and Splinter Forceps**



Short pointed jaws, flat handle. Overall length: 92mm.

AF3765	<p><b>Utility and Splinter Forceps</b></p>	
--------	--	--

LASIK FORCEPS

Item #	Description	Image
<b>Buratto LASIK Flap Forceps</b>		
Angled and curved shafts with various tip styles.		
AF3355TI	<p><b>Titanium Buratto LASIK Flap Forceps</b></p> <p>Titanium. Angled shafts, curved inward tips, 8mm from bend to tip, 0.5mm blunt round tips. Flat handle. Overall length: 104mm.</p>	
AF3600	<p><b>Stainless Steel Buratto LASIK Flap Forceps</b></p> <p>Curved shafts, 0.8mm very delicate disc-shaped tip with serrated jaws. Flat, 3-hole handle. Overall length: 102mm.</p>	

MUSCLE FORCEPS

Item #	Description	Image
<b>Berke Ptosis Forceps</b>		
Berke Ptosis Forceps have a curved tip with straight, longitudinal serrated blades. Flat, serrated handle with slide lock. Available in 20mm or 27mm jaw length.		
AF4320	<p><b>Ptosis Forceps, 20mm</b></p> <p>20mm jaw length. Overall length: 98mm.</p>	
AF4310	<p><b>Ptosis Forceps, 27mm</b></p> <p>27mm jaw length. Overall length: 104mm.</p>	
<b>Putterman Muscle Forceps</b>		
Titanium. Three pins and holes on each 22mm paddle. Overall length: 95mm.		
AF9050TI	<p><b>Putterman Muscle Forceps</b></p>	
<b>Troutman Superior Rectus Forceps</b>		
Angled shafts bent 10mm from tip. 1 x 2 teeth. Wide serrated handle. Overall length: 108mm.		
AF4400	<p><b>Troutman Superior Rectus Forceps</b></p>	

PRE-CHOPPER FORCEPS

Item #	Description	Image
--------	-------------	-------

**Akahoshi PreChop Forceps**

Akahoshi PreChop forceps with straight and angled shafts used for nucleus fragmentation. Cross-action jaws open 3mm wide, extra-pointed tip. Round handle. Overall length: 120mm.

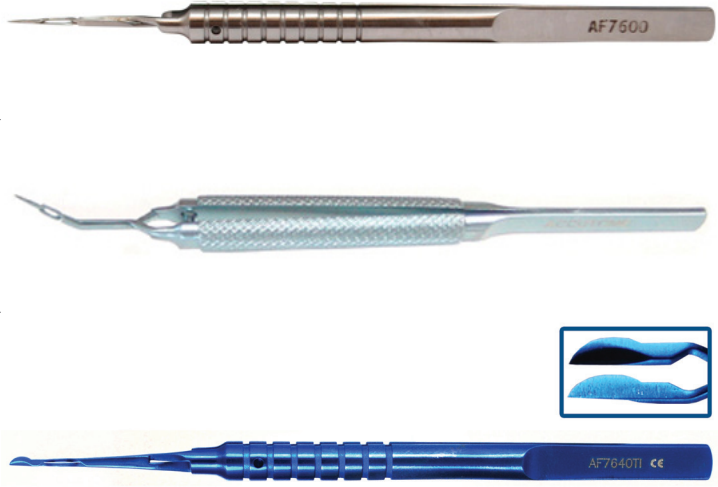
AF7600	<b>PreChop Forceps, Straight</b> Straight shafts.	
--------	--	--

AF7610	<b>PreChop Forceps, Angled</b> Angled shafts.
--------	--

AF7640TI	<b>PreChop Forceps, Straight</b> Titanium. Straight shafts.
----------	--

**D&K Salvitti Akahoshi PreChopping Forceps**

Straight shafts, reverse cross action. Fits through a 1.7mm incision and spreads 2.5mm wide. Round handle. Overall length: 124mm.

AF7635	<b>Salvitti Akahoshi Forceps</b>	
--------	----------------------------------	--

**Dodick Nucleus Cracker**

Curved shafts, serrated paddles for cracking nucleus through 3mm incision. Flat, 3-hole, cross-action handle. Overall length: 108mm.

AF3175	<b>Dodick Nucleus Cracker</b>	
--------	-------------------------------	--

**Ernest Nucleus Cracker**

Angled, cross-action shafts, serrated paddle-shaped jaws. For use through a sub 2mm incision. Flat handle. Overall length: 108mm.

AF3145TI	<b>Ernest Nucleus Cracker</b>	
----------	-------------------------------	--





PRE-CHOPPER FORCEPS

Item #	Description	Image
<b>Salz Nucleus Splitter</b>		
Titanium. Vaulted shafts. Flat handle. Overall length: 76mm.		
AF3177TI	<a href="#">Salz Nucleus Splitter</a>	

















RETINAL FORCEPS

Item #	Description	Image
<b>Scleral Plug Forceps</b>		
Curved shafts, cross-action handle. Designed for insertion and removal of plugs. Overall length: 104mm.		
AF5300	<a href="#">Scleral Plug Forceps</a>	







SUTURING FORCEPS

Item #	Description	Image
<b>Bonn Suturing Forceps</b>		
Straight shafts, 0.12mm l x 2 teeth set at 90 degrees, 5mm tying platforms. Narrow, flat handle.		
AF5100	<a href="#">Short Suturing Forceps</a> Short flat handle. Overall length: 74mm.	
AF5110	<a href="#">Long Suturing Forceps</a> Long flat handle. Overall length: 95mm.	
AF5110TI	<a href="#">Long Suturing Forceps</a> Titanium. Long flat handle. Overall length: 95mm.	

SUTURING FORCEPS

Item #	Description	Image
<b>Castroviejo Suturing Forceps</b>		
Castroviejo Suturing Forceps are available in both titanium and stainless steel options with the choice of either straight or angled shafts. Tips have 1 x 2 teeth and vary in tip size and tying platform size. Overall length: 108mm.		
AF5200	<p><b>Suturing Forceps, 0.3mm</b></p> <p>Straight shafts, 0.3mm 1 x 2 teeth, 5.5mm tying platform. Wide serrated handle.</p>	 
AF5200TI	<p><b>Titanium Suturing Forceps, 0.3mm</b></p> <p>Titanium. Straight shafts, 0.3mm 1 x 2 teeth, 5.5mm tying platform. Wide serrated handle.</p>	 
AF5170	<p><b>Suturing Forceps, 0.5mm</b></p> <p>Straight shafts, 0.5mm 1 x 2 teeth, 5.5mm tying platform. Wide serrated handle.</p>	 
AF5140	<p><b>Suturing Forceps, 0.5mm</b></p> <p>Angled shafts, 0.5mm 1 x 2 teeth, 6mm tying platform. Wide serrated handle.</p>	 
AF5170TI	<p><b>Titanium Suturing Forceps, 0.5mm</b></p> <p>Titanium. Straight shafts, 0.5mm 1 x 2 teeth, 5.5mm tying platform. Wide serrated handle.</p>	 
AF5160	<p><b>Suturing Forceps, 0.9mm</b></p> <p>Straight shafts, 0.9mm 1 x 2 teeth, 5.5mm tying platform. Wide serrated handle.</p>	 
AF5150	<p><b>Suturing Forceps, 0.12mm</b></p> <p>Straight shafts, 0.12mm 1 x 2 teeth, 5mm tying platform. Wide serrated handle.</p>	 
AF5180	<p><b>Suturing Forceps, 0.12mm</b></p> <p>Straight shafts, 0.12mm 1 x 2 teeth, 5.5mm tying platform. Wide serrated handle.</p>	 

SUTURING FORCEPS

Item #	Description	Image
AF5180K	<p><b>Suturing Forceps, 0.12mm</b></p> <p>Straight shafts, 0.12mm 1 x 2 teeth, 5.5mm tying platform. Wide, 3-hole handle.</p>	 
AF5180TI	<p><b>Titanium Suturing Forceps, 0.12mm</b></p> <p>Titanium. Straight shafts, 0.12mm 1 x 2 teeth, 5.5mm tying platform. Wide serrated handle.</p>	 
AF5190	<p><b>Suturing Forceps, 1.5mm</b></p> <p>Straight shafts, 1.5mm 1 x 2 teeth, 5.5mm tying platform. Wide serrated handle.</p>	 

**Fine-Castroviejo Suturing Forceps**

Straight shafts, 0.22mm 1 x 2 teeth, 6mm tying platform, narrow flat handle. Overall length: 111mm.

AF5210	<p><b>Fine-Castroviejo Suturing Forceps</b></p>	
--------	---	--

**Kelman-McPherson Suturing Forceps**

45-degree angled shafts, 1 x 2 teeth. Flat handle. Overall length: 86mm.

AF5225	<p><b>5mm Kelman-McPherson Forceps</b></p> <p>5mm tying platform.</p>	 
AF5220	<p><b>8mm Kelman-McPherson Forceps</b></p> <p>8mm tying platform.</p>	 

SUTURING FORCEPS

Item #	Description	Image
--------	-------------	-------

**Manhattan Eye and Ear Suturing Forceps**

Straight shafts, 1 x 2 teeth with 6mm tying platform. Flat handle. Overall length: 86mm.

AF5240	<b>Manhattan Eye and Ear Suturing Forceps</b>
--------	---



**O'Gawa Suture Fixation Forceps**

O'Gawa Suture Fixation Forceps have straight shafts, round handles, and are available in stainless steel. Tips are available in various sizes and have 1 x 2 teeth with a 5.5mm tying platform.

AF2520	<b>0.13mm Fixation Forceps</b> 0.13mm 1 x 2 teeth. Overall length: 86mm.
--------	---



AF2510	<b>0.3mm Fixation Forceps</b> 0.3mm 1 x 2 teeth. Overall length: 111mm.
--------	--



**Paufique Suturing Forceps**

Straight shafts, 1 x 2 teeth, 6mm tying platform, wide serrated handle. Overall length: 86mm.

AF5270	<b>Paufique Suturing Forceps</b>
--------	----------------------------------



**Stern-Castroviejo Suturing Forceps**

Straight shafts, 0.5mm 1 x 2 teeth, 6mm tying platform, wide flat handle with lock. Overall length: 111mm.

AF5290	<b>Stern-Castroviejo Suturing Forceps</b>
--------	---



TISSUE FORCEPS

Item #	Description	Image
--------	-------------	-------

**Adson Tissue Forceps**

Straight shafts, delicate teeth. Flat handle.

AF6135 **0.5mm Adson Tissue Forceps**  
Extra delicate, 1 x 2, 0.5mm teeth. Overall length: 120mm.



AF6137 **0.5mm Adson Tissue Forceps**  
Delicate, 2 x 3, 0.5mm teeth. Overall length: 125mm.



AF6136 **1.5mm Adson Tissue Forceps**  
Delicate, 1 x 2, 1.5mm teeth. Overall length: 120mm.



**Bishop-Harmon Tissue Forceps**

Straight shafts with teeth or serrated tips. Flat, 3-hole handle. Overall length: 89mm.

AF6100 **0.3mm Bishop-Harmon Forceps**  
0.3mm 1 x 2 teeth.

AF6101 **0.5mm Bishop-Harmon Forceps**  
0.5mm 1 x 2 teeth.

AF2105 **0.8mm Bishop-Harmon Forceps**  
0.8mm cross serrated tips.

AF6110 **0.8mm Bishop-Harmon Forceps**  
0.8mm 1 x 2 teeth.



**Hoskins Tissue Forceps**

Straight shafts, micro-groove tips. Flat, fenestrated handle. Overall length: 83mm.

AFI400 **Hoskins Forceps #19**  
Micro-groove tips.

AFI403 **Hoskins Forceps #28**  
Delicate micro-groove tips.







TISSUE FORCEPS

Item #	Description	Image
<b>Tissue Forceps</b>		
Straight shafts, 1 x 2 teeth. Flat handle. Overall length: 98mm.		
AF6130	<b>Delicate Tissue Forceps</b> Delicate 1 x 2 teeth.	
AF6140	<b>Heavy Tissue Forceps</b> Heavy 1 x 2 teeth.	

TYING FORCEPS

Item #	Description	Image
<b>Bechert-McPherson Angled Tying Forceps</b>		
Angled shafts, 10mm tying platform. Narrow serrated handle. Overall length: 86mm.		
AF6300	<b>Stainless Steel Tying Forceps</b> Stainless steel.	
AF6300TI	<b>Titanium Tying Forceps</b> Titanium.	

<b>Castroviejo Tying Forceps</b>		
Straight shafts, 5mm tying platform. Flat, wide handle. Overall length: 109mm.		
AF6455	<b>Castroviejo Tying Forceps</b>	

<b>Fine Tying Forceps</b>		
Curved shafts and tips, smooth, delicate jaws, tying platform tips. Wide serrated handle. Overall length: 108mm.		
AF6330	<b>Curved Fine Tying Forceps</b>	



TYING FORCEPS

Item #	Description	Image
--------	-------------	-------

**Gerl Tying Forceps**

Curved shafts with smooth jaws and 6mm tying platform. Flat handle. Overall length: 86mm.

AF6580 [Gerl Tying Forceps](#)



**Girard Fine Tying Forceps**

Straight shafts, ultra-fine 0.5mm tying platform. Round handle. Overall length: 100mm.

AF6351 [Girard Fine Tying Forceps](#)



**Harms-Tuebingen Tying Forceps**

Straight and curved shafts, smooth jaws. Narrow, flat handle. Overall length: 101mm.

AF6370 [Harms-Tuebingen Tying Forceps, Straight](#)  
Straight shafts, 6mm tying platform.



AF6360 [Harms-Tuebingen Tying Forceps, Curved](#)  
Curved shafts, 7mm tying platform.

















**Jaffe Tying Forceps**

Very delicate, curved, smooth jaws, 6.0mm tying platform. Flat, 3-hole handle. Overall length: 101mm.





AF6380 [Jaffe Tying Forceps](#)



TYING FORCEPS

Item #	Description	Image
<b>Kelman-McPherson Tying Forceps</b>		
Angled shafts. Flat handle. Overall length: 86mm.		
AF6400 S	<b>5mm Tying Forceps</b> 5mm bend from tip, 5mm tying platform. Flat handle.	 
AF6400	<b>7.5mm Tying Forceps</b> 8mm bend from tip, 7.5mm tying platform. Flat, 3-hole handle.	 
AF6404	<b>7.5mm Tying Forceps</b> 8mm bend from tip, 7.5mm tying platform. Narrow, flat handle.	 
AF6400TI	<b>7.5mm Tying Forceps</b> Titanium. 8mm bend from tip, 7.5mm tying platform. Narrow, flat handle.	 
<b>McPherson Tying Forceps</b>		
Straight and angled shafts. Flat handle.		
AF6410	<b>McPherson Tying Forceps, Angled</b> Angled shafts, 5mm bend from tip, 5mm tying platform. Flat, 3-hole handle. Overall length: 98mm.	 
AF6410S	<b>McPherson Tying Forceps, Angled</b> Angled shafts, 5mm bend from tip, 5mm tying platform. Flat serrated handle. Overall length: 98mm.	 
AF6410TI	<b>McPherson Tying Forceps, Angled</b> Titanium. Angled shafts, 5mm bend from tip, 5mm tying platform. Flat serrated handle. Overall length: 98mm.	 

TYING FORCEPS

Item #	Description	Image
AF6420	<p><b>McPherson Tying Forceps, Straight</b></p> <p>Straight shafts, 5mm tying platform. Flat, 3-hole handle. Overall length: 101mm.</p>	
AF6420TI	<p><b>McPherson Tying Forceps, Straight</b></p> <p>Titanium. 4mm tying platform. Flat handle. Overall length: 86mm.</p>	
AF6424	<p><b>McPherson Tying Forceps, Straight</b></p> <p>Straight shafts, 5mm tying platform. Flat serrated handle. Overall length: 101mm.</p>	
AF6421	<p><b>McPherson Tying Forceps, Straight</b></p> <p>Straight shafts, 5mm tying platform. Flat, narrow, serrated handle. Overall length: 86mm.</p>	

**O’Gawa Tying Forceps**

Curved shafts, 5.5mm tying platform, 0.3mm gap at platform heel. Round, knurled handle. Overall length: 108mm.





AF6430	<p><b>Curved Tying Forceps</b></p>	
--------	------------------------------------	--

**O’Gawa-Castroviejo Tying Forceps**

Straight shafts, 6mm tying platform tips. Wide serrated handle. Overall length: 111mm.

AF6450	<p><b>Straight Tying Forceps</b></p>	
--------	--------------------------------------	--

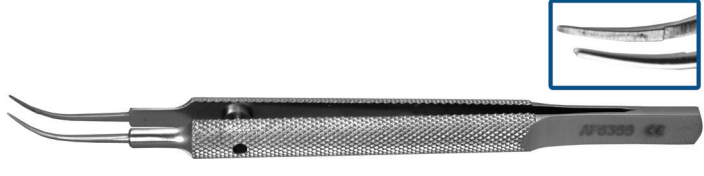
TYING FORCEPS

Item #	Description	Image
<b>Sheets-McPherson Tying Forceps</b>		
45-degree angled shafts, 10.5mm tying platform. Serrated criss-cross tips. Flat handle. Overall length: 86mm.		
AF6470	<a href="#">Sheets-McPherson Tying Forceps</a>	
<b>Tennant Tying Forceps</b>		
Tennant Tying Forceps with both straight and curved shafts. Delicate and extra delicate tips with 6mm tying platform. Round handle with guide pin.		
AF6350	<a href="#">Tennant Tying Forceps, Straight</a> Straight shafts, extra delicate. Overall length: 101mm.	
AF6350TI	<a href="#">Tennant Tying Forceps, Straight</a> Titanium. Straight shafts, extra delicate. Overall length: 101mm.	
AF6355	<a href="#">Tennant Tying Forceps, Curved</a> Curved shafts, delicate. Overall length: 98mm.	
AF6355T	<a href="#">Tennant Tying Forceps, Curved</a> Titanium. Curved shafts, delicate. Overall length: 110mm.	
AF6530	<a href="#">Tennant Tying Forceps, Curved</a> Curved shafts, extra delicate. Overall length: 98mm.	

UTILITY FORCEPS

Item #	Description	Image
--------	-------------	-------

**Alabama University Utility Forceps**

Straight shafts, fitted V-groove jaws. Flat handle. Overall length: 92mm.

AF6700	<a href="#">Alabama University Utility Forceps</a>
--------	--



**Bonaccolto Utility Forceps**

Straight shafts, with serrated tips. Flat, narrow handle. Overall length: 111mm.

AF6720	<a href="#">1.2 Utility Forceps</a> 1.2 x 16mm jaws.
--------	---

AF6710	<a href="#">1.7 Utility Forceps</a> 1.7 x 17mm jaws.
--------	---

AF6730	<a href="#">2.4 Utility Forceps</a> 2.4 x 16mm jaws.
--------	---

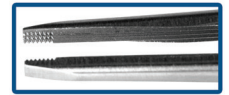

**Gill Iris Forceps**

Curved shafts, delicate, cross-serrated jaws, flat handle. Overall length: 70mm.

AF3540	<a href="#">Gill Iris Forceps</a>
--------	-----------------------------------



**Kennerdell Bayonet Forceps**

Bayonet shafts with 17mm serrated tips, 83mm bend from tip. No teeth. Overall length: 160mm.

AF6930	<a href="#">Kennerdell Bayonet Forceps</a>
--------	--



**Nugent Utility Forceps**

Nugent stainless steel utility forceps have angled shafts with 45-degree angled jaws. Jaws are available in both serrated and smooth and are 10mm long. Flat, narrow handle. Overall length: 108mm.

AF6760	<a href="#">Serrated Utility Forceps</a> Serrated tips.
--------	--





UTILITY FORCEPS





Item #	Description	Image
AF6770	<b>Smooth Utility Forceps</b> Smooth tips.	

**Wills Hospital Utility Forceps**

Straight shafts with 13mm long criss-cross serrated tips, narrow handle. Overall length: 111mm.

AF6780	<b>Wills Hospital Utility Forceps</b>	
--------	---------------------------------------	--









CLAMPS

Item #	Description	Image
<b>Clamp</b>		
Various brands of towel clamps with different types of tips and handles.		
AF6900	<b>Baby Jones Towel Clamp</b> Curved shafts, sharp pointed tips. 2 1/2" cross-action flat handle. Overall length: 55mm.	
AF6910	<b>Long Towel Clamp Forceps</b> Curved shafts, sharp pointed tips. Ring handle. Overall length: 133mm.	
AM0560	<b>Serrefine Clamp</b> Straight shafts, stainless steel, 10mm serrated jaws. Flat handle. Overall length: 36mm.	
AF6920	<b>Short Towel Clamp Forceps</b> Curved shafts, sharp pointed tips. Ring handle. Overall length: 89mm.	







# I/A & Bimanual Handpieces



DISPOSABLE I/A INSTRUMENTS

Item #	Description	Image
<b>Bimanual I/A System</b>		
Single-use bimanual I/A systems are a solution for preventing infection. These products are guaranteed to be sterile and safe from contaminants. Comes two handpieces per pack, one irrigating, one aspirating. Aspiration-handpiece 0.8 mm [21g] with curved cannula, aspiration port 0.35 mm, textured tip for capsule polishing AEROPLANE nose shape. Irrigation-handpiece 0.8 mm [21G] with curved cannula. Sold 10 per box.		
AB-9105B	<b>Single Port I/A System</b> Open ended irrigation port 0.50 mm for active rinsing.	 <p>AB-9105B</p>
AB-9110B	<b>Dual Port I/A System</b> Two irrigation ports 0.45 mm.	 <p>AB-9110B</p> 
<b>Mono-Manual I/A System</b>		
This range of coaxial I/A systems features straight and angled versions at 30 degrees, 45 degrees, and 65 degrees. All models are available as 19g, 20g, 21g, and 23g versions for incisions of 2.8mm to 1.8 mm. The textured aspiration tips can be used for selective polishing of the posterior capsule. Sold 10 per box.		
AB-9170P	<b>I/A Handpiece, 1.8mm</b> Aspiration cannula angled 45 degrees, for incisions of 1.8mm, polished aspiration head.	
AB-9175P	<b>I/A Handpiece, 1.8mm</b> Aspiration cannula curved, for incisions of 1.8mm, polished aspiration head.	
AB-9155P	<b>I/A Handpiece, 2.2mm</b> Aspiration cannula angled 45 degrees, for incisions of 2.2mm, polished aspiration head.	
AB-9160P	<b>I/A Handpiece, 2.2mm</b> Aspiration cannula curved, for incisions of 2.2mm, polished aspiration head.	
AB-9115	<b>I/A Handpiece, 2.5mm</b> Aspiration cannula straight, for incisions of 2.5mm, textured aspiration head.	
AB-9125P	<b>I/A Handpiece, 2.5mm</b> Aspiration cannula angled 45 degrees, for incisions of 2.5mm, polished aspiration head.	

DISPOSABLE I/A INSTRUMENTS

Item #	Description	Image
AB-9135	<b>I/A Handpiece, 2.5mm</b> Aspiration cannula angled 65 degrees, for incisions of 2.5mm, textured aspiration head.	
AB-9110	<b>I/A Handpiece, 2.8mm</b> Aspiration cannula straight, for incisions of 2.8mm, textured aspiration head.	
AB-9120	<b>I/A Handpiece, 2.8mm</b> Aspiration cannula angled 45 degrees, for incisions of 2.8mm, textured aspiration head.	
AB-9130	<b>I/A Handpiece, 2.8mm</b> Aspiration cannula angled 65 degrees, for incisions of 2.8mm, textured aspiration head.	

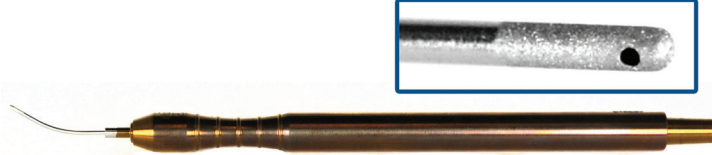
REUSABLE I/A INSTRUMENTS

Item #	Description	Image
<b>Bimanual Aspirating Unit</b>		
Reusable Bimanual Aspirating Units come in 21 gauge or 23 gauge cannula tips size options. Each cannula tip has a curved shaft with a single 0.3mm port and closed round tip. Aspirating handle is titanium. Overall length: 111mm.		
AC7032	<b>Bimanual Aspirating Unit, 21g</b> 21 gauge, smooth cannula tip.	
AC7030	<b>Bimanual Aspirating Unit, 21g</b> 21 gauge, sandblasted capsule polisher tip.	
AC7100	<b>Bimanual Aspirating Unit, 23g</b> 23 gauge, smooth cannula tip.	

REUSABLE I/A INSTRUMENTS

Item #	Description	Image
AC7110	<b>Bimanual Aspirating Unit, 23g</b> 23 gauge, sandblasted capsule polisher tip.	

**Bimanual Aspiration Cannula Tip**

Reusable Bimanual Aspiration Cannula Tips come in 21 gauge or 23 gauge with a curved shaft. This is only the tip not the whole unit. Each tip has a sandblasted capsule polisher tip with a single 0.3mm sideport. Overall length: 21mm.

AC7430	<b>Bimanual Aspiration Tip, 21g</b> 21 gauge.	
AC7431	<b>Bimanual Aspiration Tip, 23g</b> 23 gauge.	

**Bimanual Irrigating Unit**

Reusable Bimanual Irrigating Units come in 21 gauge or 23 gauge cannula tips size options. Each cannula tip has a straight or curved shaft and various tip types. Irrigating handle is titanium. Overall length: 111mm.

AC7000	<b>Bimanual Irrigating Unit, 21g</b> 21 gauge cannula tip, straight shaft, open ended.	
AC7010	<b>Bimanual Irrigating Unit, 21g</b> 21 gauge cannula tip, curved shaft, open ended.	
AC7040	<b>Bimanual Irrigating Unit, 21g</b> 21 gauge cannula tip, straight shaft, 0.5mm dual ports, closed rounded tip.	
AC7050	<b>Bimanual Irrigating Unit, 21g</b> 21 gauge cannula tip, curved shaft, 0.5mm dual ports, closed rounded tip.	
AC7130	<b>Bimanual Irrigating Unit, 23g</b> 23 gauge cannula tip, thin wall, curved shaft, 0.4mm dual ports, closed rounded tip.	



REUSABLE I/A INSTRUMENTS

Item #	Description	Image
AC7120	<p><b>Bimanual Irrigating Unit, 23g</b></p> <p>23 gauge cannula tip, thin wall, straight shaft, 0.4mm dual ports, closed rounded tip.</p>	

**Bimanual Irrigation Cannula Tip**

Reusable Bimanual Irrigation Cannula Tips come in 21 gauge or 23 gauge with a curved shaft. This is only the tip not the whole unit. Various tip types are available. Overall length: 21mm.

AC7450	<p><b>Bimanual Irrigation Tip, 21g</b></p> <p>21 gauge, 0.5mm dual ports, closed rounded tip.</p>	
--------	---	--

AC7451	<p><b>Bimanual Irrigation Tip, 23g</b></p> <p>23 gauge, thin wall, 0.4mm dual ports, closed rounded tip.</p>	
--------	--	---

AC7530	<p><b>Bimanual Irrigation Tip, 23g</b></p> <p>23 gauge, thin wall, 0.4mm dual oval ports, closed rounded tip.</p>	
--------	---	--

**Donnenfeld Irrigating Hook**

Designed in conjunction with Eric D. Donnenfeld, M.D., specifically for the placement of Toric IOLs. The stainless steel Donnenfeld Irrigating Hook is 23 gauge and has two irrigating ports that are positioned at the tip of the instrument, which open the capsular bag allowing the surgeon to rotate the Toric IOL. The hook on the bottom of the instrument gently grabs the haptic for rotation.









AC8000	<p><b>Donnenfeld Irrigating Hook</b></p>	
--------	--	--

**I/A Handpiece**

Please note that titanium handles are only interchangeable with titanium tips and stainless handles are only interchangeable with stainless tips. Replacement O-ring sets are also available for both stainless and titanium products. Please note that silicone sleeves are not included with tips.









AC5120	<p><b>Stainless Steel I/A Handpiece</b></p> <p>Male aspiration connector in stainless steel.</p>	
--------	--	--

## REUSABLE I/A INSTRUMENTS





Item #	Description	Image
AC5120T	<b>Titanium I/A Handpiece</b> Male aspiration connector in titanium.	
<b>I/A Tip</b>		
Please note that titanium handles are only interchangeable with titanium tips and stainless handles are only interchangeable with stainless tips. Replacement O-ring sets are also available for both stainless and titanium products. Please note that silicone sleeves are not included with tips.		
AC5215	<b>Coaxial I/A Tip, Straight</b> Coaxial I/A tip with straight shaft and tip. 0.5mm dual sideport aspiration and 16g irrigation sleeve.	
AC5141T	<b>Coaxial I/A Tip, Straight</b> Titanium, coaxial I/A tip with straight shaft and tip. 0.5mm dual sideport aspiration and 16g irrigation sleeve.	
AC5235T	<b>Coaxial I/A Tip, Straight</b> Titanium, 21g, coaxial I/A tip with straight shaft and tip. 0.3mm dual sideport aspiration. Made for use with silicone irrigation sleeve (sold separately).	
AC5235	<b>Coaxial I/A Tip, Straight</b> 21g, coaxial I/A tip with straight shaft and tip. 0.3mm dual sideport aspiration. Made for use with silicone irrigation sleeve (sold separately).	
AC5140	<b>Coaxial I/A Tip, Curved</b> Coaxial I/A tip with straight shaft and tip. 0.3mm dual sideport aspiration and 16g irrigation sleeve.	
AC5140T	<b>Coaxial I/A Tip, Curved</b> Titanium, coaxial I/A tip with straight shaft and tip. 0.3mm dual sideport aspiration and 16g irrigation sleeve.	
AC5150	<b>Coaxial I/A Tip, Curved</b> Coaxial I/A tip with curved shaft and straight tip. 0.3mm dual sideport aspiration and 16g irrigation sleeve.	



REUSABLE I/A INSTRUMENTS



Item #	Description	Image
AC5150T	<p><b>Coaxial I/A Tip, Curved</b></p> <p>Titanium, coaxial I/A tip with curved shaft and straight tip. 0.3mm dual sideport aspiration and 16g irrigation sleeve.</p>	
AC5151	<p><b>Coaxial I/A Tip, Curved</b></p> <p>Coaxial I/A tip with curved shaft and straight tip. 0.5mm dual sideport aspiration and 16g irrigation sleeve.</p>	
AC5151T	<p><b>Coaxial I/A Tip, Curved</b></p> <p>Titanium, coaxial I/A tip with curved shaft and straight tip. 0.5mm dual sideport aspiration and 16g irrigation sleeve.</p>	
AC5245	<p><b>Coaxial I/A Tip, Curved</b></p> <p>2lg coaxial I/A tip with curved shaft and tip. 0.3mm dual sideport aspiration. Made for use with silicone irrigation sleeve (sold separately).</p>	
AC5245T	<p><b>Coaxial I/A Tip, Curved</b></p> <p>Titanium, 2lg, coaxial I/A tip with curved shaft and tip. 0.3mm dual sideport aspiration. Made for use with silicone irrigation sleeve (sold separately).</p>	
AC5160	<p><b>Coaxial I/A Tip, 45 degrees</b></p> <p>Coaxial I/A tip with straight shaft and 45-degree angled tip. 0.3mm dual sideport aspiration and 16g irrigation sleeve.</p>	
AC5160T	<p><b>Coaxial I/A Tip, 45 degrees</b></p> <p>Titanium, coaxial I/A tip with straight shaft and 45-degree angled tip. 0.3mm dual sideport aspiration and 16g irrigation sleeve.</p>	
AC5220	<p><b>Coaxial I/A Tip, 45 degrees</b></p> <p>2lg, coaxial I/A tip with straight shaft and 45-degree angled tip. 0.3mm dual sideport aspiration. Made for use with silicone irrigation sleeve (sold separately).</p>	

## REUSABLE I/A INSTRUMENTS

Item #	Description	Image
AC5220T	<p><b>Coaxial I/A Tip, 45 degrees</b></p> <p>Titanium, 2lg, coaxial I/A tip with straight shaft and 45-degree angled tip. 0.3mm dual sideport aspiration. Made for use with silicone irrigation sleeve (sold separately).</p>	
AC5170	<p><b>Coaxial I/A Tip, 90 degrees</b></p> <p>Coaxial I/A tip with straight shaft and 90-degree curved tip. 0.3mm dual sideport aspiration and 16g irrigation sleeve.</p>	
AC5170T	<p><b>Coaxial I/A Tip, 90 degrees</b></p> <p>Titanium, coaxial I/A tip with straight shaft and 90-degree curved tip. 0.3mm dual sideport aspiration and 16g irrigation sleeve.</p>	
AC5180	<p><b>Coaxial I/A Tip, 150 degrees</b></p> <p>Coaxial I/A tip with straight shaft and 150-degree curved tip. 0.3mm dual sideport aspiration and 16g irrigation sleeve.</p>	
AC5180T	<p><b>Coaxial I/A Tip, 150 degrees</b></p> <p>Titanium, coaxial I/A tip with straight shaft and 150-degree curved tip. 0.3mm dual sideport aspiration and 16g irrigation sleeve.</p>	

# Knife Handles

**BARD-PARKER KNIFE HANDLES**

Item #	Description	Image
<b>Bard-Parker Knife Handle</b>		
Knife handle compatible with 10, 11, 12, and 15 style blades. Flat handle.		
AH2505	<b>Bard-Parker Knife, #3 Handle</b> Ruler markings. Overall length: 124mm.	
AH2506	<b>Bard-Parker Knife, #7 Handle</b> Overall length: 165mm.	
AH2510	<b>Bard-Parker Knife, #9 Handle</b> Overall length: 116mm.	



**BEAVER CHUCK KNIFE HANDLES**

Item #	Description	Image
<b>Beaver Chuck Knife Handle</b>		
Collet tip, compatible with 50, 60, and 70 series blades. Round handle. Overall length: 102mm.		
AH2515	<b>Beaver Chuck Knife, #3 Handle</b>	

# Reusable Knives









## REUSABLE KNIVES

Item #	Description	Image
<b>Gill Corneal Knife</b>		
Straight shaft, 3mm x 18mm smooth blade. Flat handle. Overall length: 119mm.		
AH2540	<a href="#">Gill Corneal Knife</a>	
<b>Martinez Double-Ended Corneal Dissector Knife</b>		
Double-ended, angled shafts, 11mm from bend to tip, 3mm wide sharp blades. Flat handle. Overall length: 127mm.		
AH2595	<a href="#">Martinez Double-Ended Corneal Knife</a>	
<b>Tooke Corneal Knife</b>		
Straight shaft, 3mm x 18mm smooth blade. Flat handle. Overall length: 119mm.		
AH2580	<a href="#">Tooke Corneal Knife</a>	

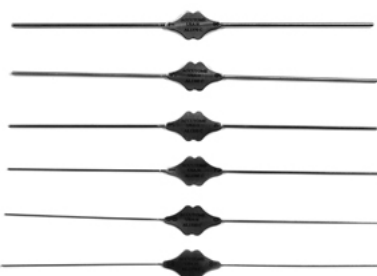

# Lacrimal Instruments

## LACRIMAL PROBES

Item #	Description	Image
<b>Bowman Lacrimal Probe Set</b>		
Set of six stainless steel probes. Double-ended. Overall length: 149mm.		
AL1375	<a href="#">Bowman Lacrimal Probe Set</a>	
<b>Bowman Lacrimal Probe</b>		
Variety of sizes. Sterling silver. Overall length: 149mm.		
AL1330	<a href="#">Bowman Lacrimal Probe Sizes 0000 and 000</a> Sizes: 0000 and 000.	
AL1320	<a href="#">Bowman Lacrimal Probe Sizes 00 and 0</a> Sizes: 00 and 0.	
AL1340	<a href="#">Bowman Lacrimal Probe Sizes 1 and 2</a> Sizes: 1 and 2.	
AL1350	<a href="#">Bowman Lacrimal Probe Sizes 3 and 4</a> Sizes: 3 and 4.	
AL1360	<a href="#">Bowman Lacrimal Probe Sizes 5 and 6</a> Sizes: 5 and 6.	

LACRIMAL PROBES

Item #	Description	Image
ALI370	<b>Bowman Lacrimal Probe Sizes 7 and 8</b> Sizes: 7 and 8.	

**Catalano Intubation Probe Set**

Set of two, 0.7mm diameter probes attached to 30.5cm long silicone tubing, 0.012" I.D., 0.025" O.D.

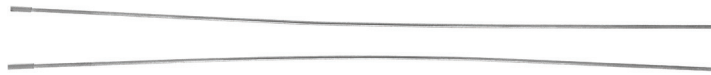
ALI530	<b>Catalano Intubation Set</b>	
--------	--------------------------------	--

**Pigtail Probe**

Stainless steel, double-ended, straight shafts with pigtail curved probes on both ends, 8mm blunt probe tips with suture eye holes. Round handle. Overall length: 143mm.

ALI420	<b>Pigtail Probe</b>	
--------	----------------------	---

**Jackson Lacrimal Intubation Set**







2 blunt 0.9mm diameter probes, attached to 30.5cm long silicone tubing, 0.012" I.D., 0.025" O.D.

ALI400	<b>Jackson Lacrimal Intubation Set</b>	
--------	--	--

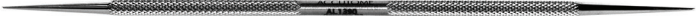
LACRIMAL DILATORS

Item #	Description	Image
	<b>Castroviejo Double-Ended Lacrimal Dilator</b>	
	One needle-point end and one medium-taper end, round, knurled handle. Overall length: 140mm.	
ALI380	<b>Castroviejo Lacrimal Dilator</b>	

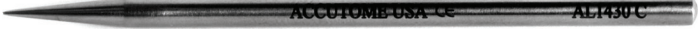
## LACRIMAL DILATORS

Item #	Description	Image
<b>Hosford Double-Ended Lacrimal Dilator</b>		
2.0mm tapered end, gradually tapered other end, rounded handle. Overall length 140mm.		
AL1390	<a href="#">Hosford Double-Ended Lacrimal Dilator</a>	 
<b>Infant Lacrimal Dilator</b>		
Very fine, blunt tip. Round handle. Overall length: 79mm.		
AL1280	<a href="#">Infant Lacrimal Dilator</a>	
<b>Muldoon Lacrimal Dilator</b>		
Medium 27mm taper, distal end is straight to act as a guide for the tapered dilator that follows. Round, knurled handle. Overall length: 98mm.		
AL1410	<a href="#">Muldoon Lacrimal Dilator</a>	
<b>Ruedemann Lacrimal Dilator</b>		
Short 12mm taper, needle type. Round handle. Overall length: 73mm.		
AL1430	<a href="#">Ruedemann Lacrimal Dilator</a>	 
<b>Wilder Lacrimal Dilator</b>		
Long, medium, and short taper, blunt tip, round handle. Overall length: 98mm.		
AL1440	<a href="#">Wilder Lacrimal Dilator, Long</a> Long 32mm taper.	
AL1450	<a href="#">Wilder Lacrimal Dilator, Medium</a> Medium 23mm taper.	
AL1460	<a href="#">Wilder Lacrimal Dilator, Short</a> Short 19mm taper.	

# LASEK Instruments

LASEK INSTRUMENTS

Item #	Description	Image
--------	-------------	-------

**Camellin LASEK Trephine**

Doubled-ended. Flat handle. Overall length: 114mm.

AR0580	<p><b>8mm Camellin LASEK Trephine</b> 8mm LASEK trephine with 8.5mm alcohol well.</p>
--------	---

AR0585	<p><b>9mm Camellin LASEK Trephine</b> 9mm LASEK trephine with 9.5mm alcohol well</p>
--------	--



**LASEK Alcohol Well**

7.5mm to 9.5mm diameter. Round handle.

AR0603	<p><b>7.5mm LASEK Alcohol Well</b> 7.5mm diameter.</p>
--------	--

AR0600	<p><b>8.5mm LASEK Alcohol Well</b> 8.5mm diameter</p>
--------	---

AR0602	<p><b>9.0mm LASEK Alcohol Well</b> 9.0mm diameter.</p>
--------	--

AR0605	<p><b>9.5mm LASEK Alcohol Well</b> 9.5mm diameter.</p>
--------	--



**LASEK Epithelial Trephine**

8.0mm and 9.5mm diameter. Round handle.

AR0610	<p><b>8.0mm LASEK Epithelial Trephine</b> 8.0mm diameter.</p>
--------	---





AR0616	<p><b>9.5mm LASEK Epithelial Trephine</b> 9.5mm diameter.</p>
--------	---





# Lens Loops

## LENS LOOPS

Item #	Description	Image
<b>Gills-Welsh Lens Loop</b>		
Slightly curved loop tip, ultra thin and smooth loop. Flat handle.		
AH3110	<b>Gills-Welsh Lens Loop</b> Straight shaft, 6mm wide x 7mm long loop. Overall length: 135mm.	
<b>Double-Ended Gills-Welsh Lens Loop</b>		
Double-ended. One side has a straight shaft with 5mm wide x 7mm long loop. One side has a curved shaft with olive-shaped tip. Overall length: 121mm.		
AH3200		
<b>Kansas Lens Loop</b>		
Curved shaft, 3.0mm wide-looped tip, serrated. Flat handle. Overall length: 137mm.		
AH3130	<b>Kansas Lens Loop</b>	
<b>Keener-Alt Lens Loop</b>		
Straight shaft, curved loop tip, serrated loop, 3mm wide loop. Flat handle. Overall length: 137mm.		
AH3150	<b>Keener-Alt Lens Loop</b>	
<b>Kirby Intra-Capsular Lens Loop</b>		
Straight shaft, 5mm x 10mm, curved, smooth loop tip. Round handle. Overall length: 138mm.		
AH3170	<b>Kirby Intra-Capsular Lens Loop</b>	

LENS LOOPS

Item #	Description	Image
--------	-------------	-------

**Lewis Lens Loop**

Straight shaft, curved tear-drop-shaped loop. Flat handle. Overall length: 134mm.

AH3180	<b>Lewis Lens Loop, Large</b> Large 5mm x 7mm loop.
--------	--

AH3190	<b>Lewis Lens Loop, Small</b> Small 4mm x 6mm loop.
--------	--



**New Orleans Eye and Ear Lens Loop**

Straight shaft, curved loop tip, 5mm wide x 10mm long smooth oval loop. Flat handle. Overall length: 142mm.

AH3210	<b>New Orleans Eye and Ear Lens Loop</b>
--------	--



**Simcoe Double-Ended Nucleus Loop**

Double-ended, both ends angled loops, 4mm wide x 20mm long loops, serrations on tops of loops. Round handle. Overall length: 140mm.

AH3220	<b>Simcoe Double-Ended Nucleus Loop</b>
--------	---



**Wilder Lens Loop**

Straight shaft, curved tip, long tear-drop-shaped loop, serrated 4mm x 14mm loop. Flat handle. Overall length: 136mm.

AH3230	<b>Wilder Lens Loop</b>
--------	-------------------------















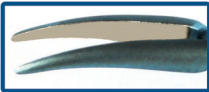

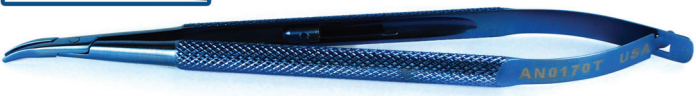

# Needle Holders

## LOCKING NEEDLE HOLDERS





Item #	Description	Image
<b>Anis Needle Holder, Locking</b>		
Stainless steel Anis Needle Holders with locking mechanisms come with either a straight or curved extra delicate 8mm jaw pattern. Overall length: 127mm.		
AN0120	<b>Anis Needle Holder, Curved</b> Curved shaft.	
AN0140	<b>Anis Needle Holder, Straight</b> Straight shaft.	
<b>Barraquer Needle Holder, Locking</b>		
Straight and curved jaws, with various jaw sizes and styles. Comes with a locking mechanism.		
AN0210	<b>Barraquer Needle Holder, Straight</b> Straight, 9mm delicate jaws with lock. Overall length: 130mm.	
AN0210T1	<b>Barraquer Needle Holder, Straight</b> Titanium. Straight, 9mm delicate jaws with lock. Overall length: 130mm.	
AN0150	<b>Barraquer Needle Holder, Curved</b> Curved, 9mm delicate jaws with lock. Overall length: 130mm.	
AN0510	<b>Barraquer Needle Holder, Curved</b> Curved, 9mm medium jaws with lock. Overall length: 130mm.	
AN0150T1	<b>Barraquer Needle Holder, Curved</b> Titanium, curved, 9mm delicate jaws with lock. Overall length: 133mm.	
AN0160	<b>Barraquer Needle Holder, Curved</b> Curved, 9mm standard jaws with lock. Overall length: 130mm.	
		



LOCKING NEEDLE HOLDERS

Item #	Description	Image
AN0160TI	<b>Barraquer Needle Holder, Curved</b> Titanium, curved, 9mm medium jaws with lock. Overall length: 130mm.	 
AN0170T	<b>Barraquer Needle Holder, Curved</b> Titanium, curved, 10mm fine jaws with lock. Overall length: 136mm.	 
<b>Castroviejo Needle Holder, Locking</b>		
Straight and curved jaws, with various jaw sizes and styles. Comes with a locking mechanism.		
AN0310	<b>Castroviejo Needle Holder, Straight</b> Straight, 9mm fine jaws with lock. Overall length: 139mm.	 
AN0270	<b>Castroviejo Needle Holder, Straight</b> Straight, 9mm medium jaws with lock. Overall length: 140mm.	 
AN0300	<b>Castroviejo Needle Holder, Straight</b> Straight, 10mm medium jaws with lock. Overall length: 136mm.	 
AN0300TI	<b>Castroviejo Needle Holder, Straight</b> Titanium. Straight, 10mm medium jaws with lock. Overall length: 136mm.	 
AN0290	<b>Castroviejo Needle Holder, Straight</b> Straight, 12mm heavy jaws with lock. Overall length: 136mm.	 
AN0280	<b>Castroviejo Needle Holder, Straight</b> Straight, 16mm heavy jaws with lock. Overall length: 149mm.	 

## LOCKING NEEDLE HOLDERS

Item #	Description	Image
AN0230	<b>Castroviejo Needle Holder, Curved</b> Curved, 9mm fine jaws with lock. Overall length: 139mm.	 A pair of curved needle holders with fine serrated jaws. The handle is silver with a locking mechanism. A close-up inset shows the fine serrations on the jaws.
AN0240	<b>Castroviejo Needle Holder, Curved</b> Curved, 11mm medium jaws with lock. Overall Length: 135mm.	 A pair of curved needle holders with medium serrated jaws. The handle is silver with a locking mechanism. A close-up inset shows the medium serrations on the jaws.
AN0240TI	<b>Castroviejo Needle Holder, Curved</b> Titanium, curved, 11mm medium jaws with lock. Overall length: 136mm.	 A pair of curved needle holders with medium serrated jaws, made of titanium. The handle is blue with a locking mechanism. A close-up inset shows the medium serrations on the jaws.
AN0250	<b>Castroviejo Needle Holder, Curved</b> Curved, 12mm standard jaws with lock. Overall length: 136mm.	 A pair of curved needle holders with standard serrated jaws. The handle is silver with a locking mechanism. A close-up inset shows the standard serrations on the jaws.

**Jaffe Needle Holder**

Straight, delicate jaws with lock. Flat, 3-hole handle.







AN0400	<b>Jaffe Needle Holder</b>	 A pair of straight needle holders with delicate jaws. The handle is silver with a locking mechanism and three finger loops. A close-up inset shows the delicate jaws.
--------	----------------------------	--

**Kalt Needle Holder**













Kalt Needle Holders with straight jaws. Available in standard, medium, or heavy jaws with or without serration. Flat, cross-action handle. Overall length: 143mm.

AN0410	<b>Heavy Needle Holder</b> Straight, heavy 12mm serrated jaws with lock.	 A pair of straight needle holders with heavy serrated jaws. The handle is silver with a locking mechanism and a cross-action design.
AN0430	<b>Medium Needle Holder</b> Straight, medium 10mm finely serrated jaws with lock.	
AN0440	<b>Standard Needle Holder</b> Straight, standard 10mm jaws with lock.	

## LOCKING NEEDLE HOLDERS

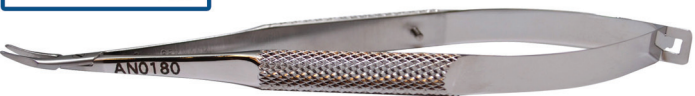
Item #	Description	Image
<b>McPherson Needle Holder</b>		
McPherson Needle Holders are available in both straight and curved, very delicate 11mm jaw options. Comes with locking mechanism. Flat, cross-action handle. Overall length: 107mm.		
AN0460	<b>Needle Holder, Curved</b> Strongly curved jaws.	
AN0480	<b>Needle Holder, Straight</b> Straight jaws.	
<b>Needle Holder, Locking</b>		
Various stainless steel or titanium needle holders with curved or straight shafts. Different jaw sizes and styles are available. Comes with locking mechanism.		
AN0500	<b>Needle Holder, Curved</b> Curved, 6mm extra delicate jaws with lock. Overall length: 120mm.	
AN0620	<b>Needle Holder, Curved</b> Titanium, curved, 9mm delicate jaws with lock. Overall length: 130mm.	
AN0540	<b>Needle Holder, Straight</b> Straight, 6mm extra delicate jaws with lock. Overall length: 120mm.	
<b>Troutman Needle Holder</b>		
Gently curved, medium 9mm smooth jaws with lock. Round handle with longitudinal serrations. Overall length: 120mm.		
AN0600	<b>Troutman Needle Holder</b>	

## NON-LOCKING NEEDLE HOLDERS

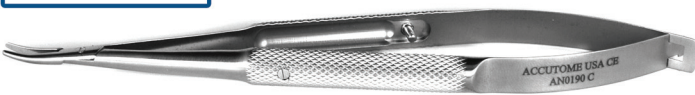
Item #	Description	Image
<b>Anis Needle Holder, Non-Locking</b>		
Anis Needle Holders without locks come with either straight or curved 8mm delicate jaws. Various jaw styles are available. Overall length: 127mm.		
AN0110	<b>Anis Needle Holder, Curved</b> Curved jaws.	 
AN0110TI	<b>Anis Needle Holder, Curved</b> Titanium. Curved jaws.	 
AN0130	<b>Anis Needle Holder, Straight</b> Straight jaws.	 
<b>Barraquer Needle Holder, Non-Locking</b>		
Straight and curved jaws, with various jaw sizes and styles. No locking mechanisms.		
AN0220	<b>Barraquer Needle Holder, Straight</b> Straight, 9mm jaws. Overall length: 133mm.	 
AN0180	<b>Barraquer Needle Holder, Curved</b> Curved, 9mm jaws. Overall length: 130mm.	 
AN0180TI	<b>Barraquer Needle Holder, Curved</b> Titanium. Curved, 9mm jaws. Overall length: 130mm.	 
AN0190	<b>Barraquer Needle Holder, Curved</b> Curved, 9mm jaws. Overall length: 130mm.	 





NON-LOCKING NEEDLE HOLDERS

Item #	Description	Image
AN0200	<b>Barraquer Needle Holder, Curved</b> Curved, 10mm jaws. Overall length: 130mm.	
AN0200TI	<b>Barraquer Needle Holder, Curved</b> Titanium. Curved, 10mm jaws. Overall length: 136mm.	
AN0170	<b>Barraquer Needle Holder, Curved</b> Curved, 11mm jaws. Overall length: 130mm.	
AN0145	<b>Barraquer Needle Holder, Curved</b> Curved, 9mm jaws. Overall length: 95mm.	

**Castroviejo Needle Holder, Non-Locking**

Straight and curved medium 10mm jaws. No locking mechanism. Overall length: 136mm.

AN0260	<b>Castroviejo Needle Holder, Curved</b> Curved jaws.	
AN0320	<b>Castroviejo Needle Holder, Straight</b> Straight jaws.	

**Cohan Needle Holder**

Titanium, curved, 7.5mm fine jaws. No locking mechanism. Overall length: 104mm

AN0350TI	<b>Cohan Needle Holder</b>	
----------	----------------------------	--

## NON-LOCKING NEEDLE HOLDERS

Item #	Description	Image
<b>McPherson Needle Holder</b>		
McPherson Needle Holders are available in both straight and curved 11mm jaw options. No locking mechanism. Flat, squeeze handle. Overall length: 107mm.		
AN0470	<b>Needle Holder, Curved</b> Strongly curved, very delicate 11mm jaws.	
AN0490	<b>Needle Holder, Straight</b> Straight, very delicate 11mm jaws.	
<b>Needle Holder, Non-Locking</b>		
Various stainless steel or titanium needle holders with curved or straight shafts. Different jaw sizes and styles are available. No locking mechanism. Flat, squeeze handle.		
AN0560	<b>Needle Holder, Straight</b> Straight, 6mm extra delicate jaws. Overall length: 120mm.	
AN0520	<b>Needle Holder, Curved</b> Curved, 9mm extra delicate jaws. Overall length: 120mm.	
AN0625	<b>Needle Holder, Curved</b> Titanium, curved, 9mm medium jaws. Overall length: 109mm.	
<b>O'Gawa Needle Holder</b>		
Curved, 8mm delicate jaws. No locking mechanism. Flat, squeeze handle. Overall length: 130mm.		
AN0525	<b>O'Gawa Needle Holder</b>	



## NON-LOCKING NEEDLE HOLDERS

Item #	Description	Image
<b>Osher Needle Holder</b>		
Curved, 9mm delicate jaws. No locking mechanism. Flat, squeeze handle. Overall length: 110mm.		
AN0700	<a href="#">Osher Needle Holder</a>	The image shows an Osher Needle Holder (AN0700). It features curved, 9mm delicate jaws. The handle is flat and has a textured grip. The overall length is 110mm. A blue box highlights the tip of the jaws. The item number AN0700 is visible on the handle.
<b>Troutman Needle Holder</b>		
Gently curved, medium 9mm smooth jaws. No locking mechanism. Round, squeeze handle with longitudinal serrations. Overall length: 120mm.		
AN0610	<a href="#">Troutman Needle Holder</a>	The image shows a Troutman Needle Holder (AN0610). It features gently curved, medium 9mm smooth jaws. The handle is round and has longitudinal serrations. The overall length is 120mm. The item number AN0610 is visible on the handle.



# Office Instruments

## OPHTHALMIC BURRS

Item #	Description	Image
--------	-------------	-------

**Aaron Burr 2**

The Bovie Aaron Burr 2 is ideal for neurological procedures. Aaron Burr 2 includes one disposable 1mm burr tip (AXI3070) for corneal rust ring removal. An AA alkaline battery is included, and it also comes with a foam-lined case.

AXI3929 **Aaron Burr 2**

**Aaron Burr 2 Accessories**

The Bovie Aaron Burr 2 is ideal for neurological procedures. Aaron Burr 2 has various burr accessories that range in tip size.

AXI4029 **0.5mm Burr Tip**  
0.5mm disposable burr tip for use with Bovie AB03, AB04, or equivalent. Sold 10 per box. Overall length: 43mm.

AXI3070 **1mm Burr Tip**  
1.0mm disposable burr tip for use with Aaron Burr 2 (AXI3929) or equivalent. For corneal rust ring removal. Sold 10 per box. Overall length: 39mm.

AXI4533 **2.5mm Burr Tip**  
2.5mm reusable burr tip for use with Aaron Burr 2 (AXI3929) or equivalent. Sold 1 per box. Overall length: 105mm.

AXI3930 **5mm Burr Tip**  
5mm reusable diamond burr tip for use with Aaron Burr 2 (AXI3929) or equivalent. Sold 1 per box. Overall length: 127mm.

**Algerbrush II**

The Algerbrush II has a very low torque motor powered by a single AA battery. The burr in this rotary instrument is used as a "brush" rather than as a drill and the rust ring is thus "brushed" from the cornea or sclera leaving a smooth surface, which heals much faster than with other instruments used for this purpose. Algerbrush II foreign body rust ring remover. Single speed, motorized, AA battery operated handpiece. Comes with tip cover, chuck, and 0.5mm burr. Overall Length: 105mm.

AM0100 **Algerbrush II Corneal Rust Remover**

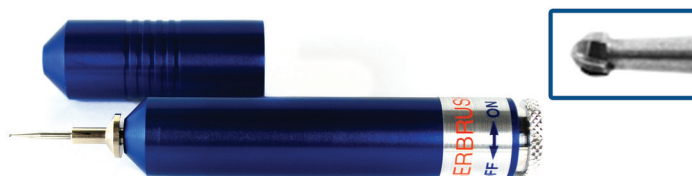
**Algerbrush II Accessories**

Accessories for the Algerbrush II foreign body rust ring remover. This includes various types and sizes of burrs as well as chucks.

AM0105 **Algerbrush Chuck**  
Algerbrush II replacement chuck.

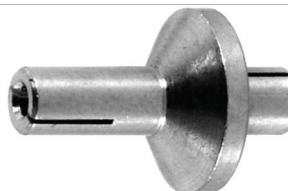





OPHTHALMIC BURRS

Item #	Description	Image
AM0110	<p><b>Algerbrush 0.5mm Burr</b></p> <p>Algerbrush II 0.5mm replacement burr, burr only. Overall length: 22mm.</p>	
AM0120	<p><b>Algerbrush 1.0mm Burr</b></p> <p>Algerbrush II 1.0mm replacement burr, burr only. Overall length: 22mm.</p>	
AM0125	<p><b>Algerbrush 2.5mm Ball</b></p> <p>Algerbrush II 2.5mm replacement round, fine grit, diamond ball, tip only. Overall length: 30mm.</p>	
AM0126	<p><b>Algerbrush 3.5mm Ball</b></p> <p>Algerbrush II 3.5mm replacement round, medium grit, diamond ball, tip only. Overall length: 22mm.</p>	
AM0128	<p><b>Algerbrush 4.0mm Wheel</b></p> <p>Algerbrush II 4.0mm replacement fine grit, diamond wheel, tip only. Overall length: 44mm.</p>	
AM0127	<p><b>Algerbrush 5.0mm Wheel</b></p> <p>Algerbrush II 5.0mm replacement medium grit, diamond wheel, tip only. Overall length: 44mm.</p>	

FOREIGN BODY INSTRUMENTS

Item #	Description	Image
<p><b>Ellis Foreign Body Spud</b></p> <p>Straight shaft, curved tip, 1mm rounded blade. Flat handle. Overall length: 117mm.</p>		
AH6500	<p><b>Ellis Foreign Body Spud</b></p>	

## FOREIGN BODY INSTRUMENTS

Item #	Description	Image
<b>Foreign Body Curette</b>		
Straight shaft, 3mm shaft, 1mm cup tip. Flat handle. Overall length: 127mm.		
AH0260	<a href="#">Foreign Body Curette</a>	 <p>The image shows a Foreign Body Curette (AH0260) with a long, thin shaft and a small cup-shaped tip. A magnified inset shows the cup tip. The handle is flat and has 'ACCUTOME CE' and '127mm' printed on it.</p>
<b>Foreign Body Spud</b>		
Straight shaft, lance-shaped tip, gently curved, 2mm tip. Flat handle. Overall length: 120mm.		
AH6510	<a href="#">Foreign Body Spud</a>	 <p>The image shows a Foreign Body Spud (AH6510) with a long, thin shaft and a lance-shaped tip. A magnified inset shows the tip. The handle is flat and has 'ACCUTOME AH6510' and '120mm' printed on it.</p>
<b>Francis Spud</b>		
Straight shaft, flag-shaped tip with sharp edge. Flat handle. Overall length: 120mm.		
AH6520	<a href="#">Francis Spud</a>	 <p>The image shows a Francis Spud (AH6520) with a long, thin shaft and a flag-shaped tip. A magnified inset shows the tip. The handle is flat and has 'ACCUTOME' and 'AH6520' printed on it.</p>
<b>Golf Club Spud</b>		
Straight shaft, golf-club-shaped with sharp edge. Flat serrated handle. Overall length: 119mm.		
AH6530	<a href="#">Golf Club Spud</a>	 <p>The image shows a Golf Club Spud (AH6530) with a long, thin shaft and a golf-club-shaped tip. The handle is flat and serrated, with 'ACCUTOME AH6530' printed on it.</p>



## SCLERAL DEPRESSORS

Item #	Description	Image
--------	-------------	-------

**Flynn Scleral Depressor**

Pediatric size. Straight shaft, lens loop style tip. Flat serrated handle. Overall length: 80mm.

AH0300	<a href="#">Flynn Scleral Depressor</a>	
--------	---	--

**Schepens Scleral Depressor**

Large, medium, and small Schepens Scleral Depressors are thimble shaped with 8mm wide depressor tips. Stainless steel with dull finish. Overall length: 43mm.

AL1120	<a href="#">Small Scleral Depressor</a> Size 8 small thimble.	
--------	--	--

AL1100	<a href="#">Medium Scleral Depressor</a> Size 10 medium thimble.	
--------	---	--

AL1110	<a href="#">Large Scleral Depressor</a> Size 12 large thimble.	
--------	---	--

**Schocket Double-Ended Scleral Depressor**

Stainless steel. Slightly angled shafts, 16mm from bend to tip. T-shaped hammerhead tip on one side and ball-shaped tip on the other. Flat handle, comes with pocket clip. Overall length: 137mm.

AL1130	<a href="#">Schocket Double-Ended Scleral Depressor</a>	
--------	---	--





# Punches



PUNCHES

Item #	Description	Image
<b>Kelly Descemet's Membrane Punch</b>		
Stainless steel Kelly Descemet's Membrane Punch produces round punches without tissue tags. Punches have serrated squeeze action handles. Overall length: 130mm.		
AM0410	<p data-bbox="256 447 503 478"><b>0.75mm Membrane Punch</b></p> <p data-bbox="256 478 609 510">Produces an exact 0.75mm round hole.</p>	
AM0410 1.00	<p data-bbox="256 520 487 552"><b>1.0mm Membrane Punch</b></p> <p data-bbox="256 552 592 583">Produces an exact 1.0mm round hole.</p>	

# Retinal Picks

RETINAL PICKS

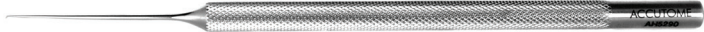
Item #	Description	Image
<b>Olk Angled Retinal Pick</b>		
Straight shaft, 0.5mm angled tip, squared. Round handle. Overall length: 125mm.		
AH5290	<b>110-Degree Retinal Pick</b> 110-degree tip angle.	
AH5310	<b>150-Degree Retinal Pick</b> 150-degree tip angle.	



# Scissors

CORNEAL SCISSORS

Item # Description Image

Aebli Corneal Scissors

Angled and straight blades and universal standard pattern with blunt tips.

AS0120 Aebli Corneal Scissors, Straight Straight 19mm blades. Ring handle. Overall length: 92mm.



AS0110 Aebli Corneal Scissors, Straight Straight 21mm blades. Ribbon handle. Overall length: 99mm.



AS0100 Aebli Corneal Scissors, Angled Angled 21mm blades. Ribbon handle. Overall length: 99mm.



Aebli Corneal Section Scissors

Angled left and right 18mm blades, blunt tips. Flat, squeeze handle. Overall length: 120mm.

AS0310 Aebli Corneal Scissors, Angled Right Angled right blades.



**CORNEAL SCISSORS**

Item #	Description	Image
AS0320	<b>Aebli Corneal Scissors, Angled Left</b> Angled left blades.	

**Manson-Aebli Corneal Scissors**

Angled left and right 19mm blades, lower blade 1.5mm longer than upper blade, blunt tips. Flat squeeze handle. Overall length: 120mm.

AS1115	<b>Corneal Scissors, Angled Right</b> Angled right blades.	
AS1105	<b>Corneal Scissors, Angled Left</b> Angled left blades.	

**Azar Corneal Scissors**

Curved 16mm blades, universal medium model, blunt tips, calibration marks at 1mm to 6mm. Flat handle. Overall length: 115mm.

AS0130	<b>Azar Corneal Scissors</b>	
--------	------------------------------	---



**Barraquer Corneal Section Scissors**

Angled left and right 19 mm blades, 45-degree angle, blunt tips. Flat squeeze handle, locking handle.





AS1110	<b>Left Section Scissors</b> Angled left blades.	
AS1120	<b>Right Section Scissors</b> Angled right blades.	

**Castroviejo Corneal Scissors**

Curved and angled blades with blunt tips and flat squeeze handle.



AS0150	<b>Castroviejo Corneal Scissors, Miniature</b> Curved 11mm blades, universal miniature model, fine tips. Overall length: 106mm.	
AS0180	<b>Castroviejo Corneal Scissors, Miniature</b> Curved left 11mm blades, miniature model. Overall length: 106mm.	

CORNEAL SCISSORS

Item #	Description	Image
AS0190	<b>Castroviejo Corneal Scissors, Miniature</b> Curved right 11mm blades, miniature model. Overall length: 106mm.	
AS0140	<b>Castroviejo Corneal Scissors, Miniature</b> Straight 19mm blades, universal miniature model. Overall length: 106mm.	
AS0200	<b>Castroviejo Corneal Scissors, Medium</b> Strong curved 16mm blades, universal medium model. Overall length: 115mm.	
AS0170	<b>Castroviejo Corneal Scissors, Medium</b> Medium curved 16mm blades, universal medium model. Overall length: 115mm.	
AS0160	<b>Castroviejo Corneal Scissors, Medium</b> Medium curved 16mm blades, universal medium model. 3-hole handle. Overall length: 115mm.	











Castroviejo Corneal Section Scissors

Curved and angled blades with flat squeeze handle.

AS1150	<b>Castroviejo Corneal Scissors, Left</b> Curved left 9mm blades, lower blade 0.5mm longer than upper blade, sub-miniature model, blunt tips. Overall length: 103mm.	
AS1200	<b>Castroviejo Corneal Scissors, Right</b> Curved right 9mm blades, lower blade 0.5mm longer than upper blade, sub-miniature model, blunt tips. Overall length: 103mm.	
AS1160	<b>Castroviejo Corneal Scissors, Left</b> Curved left 13mm blades, lower blade 0.5mm longer than upper blade, mid-miniature model, blunt tips. Overall length: 106mm.	



**CORNEAL SCISSORS**

Item #	Description	Image
ASI210	<p><b>Castroviejo Corneal Scissors, Right</b></p> <p>Curved right 13mm blades, mid-miniature model, lower blade 0.5mm longer than upper blade, blunt tips. Overall length: 106mm.</p>	 
ASI170	<p><b>Castroviejo Corneal Scissors, Left</b></p> <p>Angled left 14mm blades, blunt tips, lower blade 0.5mm longer than upper blade. Overall length: 106mm.</p>	 
ASI220	<p><b>Castroviejo Corneal Scissors, Right</b></p> <p>Angled right 14mm blades, blunt tips, lower blade 0.5mm longer than upper blade. Overall length: 106mm.</p>	 
ASI140	<p><b>Castroviejo Corneal Scissors, Left</b></p> <p>Angled left 18mm blades, curved to conform to the curve of the limbus, lower blade 1mm longer than upper blade, blunt tips. Overall length: 112mm.</p>	 
ASI190	<p><b>Castroviejo Corneal Scissors, Right</b></p> <p>Angled right 18mm blades, curved to conform to the curve of the limbus, lower blade 1mm longer than upper blade, blunt tips. Overall length: 112mm.</p>	 



**Castroviejo Keratoplasty Scissors**

Angled to side 16mm blades, universal model, medium, lower blade 1mm longer than upper blade, blunt tips. Flat handle. Overall length: 110mm.



AS0210	<p><b>Castroviejo Keratoplasty Scissors</b></p>	 
--------	---	--

**Hoffer-Stern Scissors**



Angled forward 10mm blades, extra thin, blunt tips. Flat, serrated handle. Overall length: 112mm.

AS5560	<p><b>Hoffer-Stern Curved Scissors</b></p>	 
--------	--	--

## CORNEAL SCISSORS

Item #	Description	Image
<b>Katzin Corneal Transplant Scissors</b>		
Curved left and right blades, lower blade 12mm, upper blade 11mm, miniature model, blunt tips. Flat 3-hole, squeeze handle. Overall length: 108mm.		
AS0220	<b>Katzin Curved Corneal Scissors, Right</b> Strongly curved right blades.	
AS0230	<b>Katzin Curved Corneal Scissors, Left</b> Strongly curved left blades.	
<b>Troutman-Castroviejo Corneal Section Scissors</b>		
Curved left and right 13mm blades, miniature model, blunt tips. Flat handle, locking handle.		
AS1270	<b>Troutman-Castroviejo Scissors, Left</b> Curved left blades. Overall length: 116mm.	
AS1290	<b>Troutman-Castroviejo Scissors, Right</b> Curved right blades. Overall length: 105mm.	
<b>Troutman-Katzin Corneal Transplant Scissors</b>		
Strongly curved left blades, small, blunt tips. Flat, 3-hole, locking handle. Overall length: 105mm.		
AS0290	<b>Troutman-Katzin Corneal Scissors</b>	

## ENUCLEATION SCISSORS

Item #	Description	Image
<b>Enucleation Scissors</b>		
Curved blades, heavy, blunt, rounded tips. Ring handle. Overall length: 131mm.		
AS2120	<b>Enucleation Scissors, Strong Curve</b> Strongly curved 40mm blades.	
AS2110	<b>Enucleation Scissors, Medium Curve</b> Medium curved 44mm blades.	
		





ENUCLEATION SCISSORS

Item #	Description	Image
AS2100	<p><b>Enucleation Scissors, Light Curve</b>                      Lightly curved 44mm blades.</p>	



EYE SCISSORS

Item #	Description	Image
<b>Eye Scissors</b>		
Straight and curved blades, 29mm and 30mm blades.		
AS5130	<p><b>Eye Scissors, Curved</b>                      Curved 29mm blades, blunt tips. Ribbon handle. Overall length: 107mm.</p>	
AS5120	<p><b>Eye Scissors, Straight</b>                      Straight 29mm blades, sharp, pointed tips. Ribbon handle. Overall length: 109mm.</p>	
AS5160	<p><b>Eye Scissors, Straight</b>                      Straight 29mm blades, round, blunt tips. Ribbon handle. Overall length: 107mm.</p>	



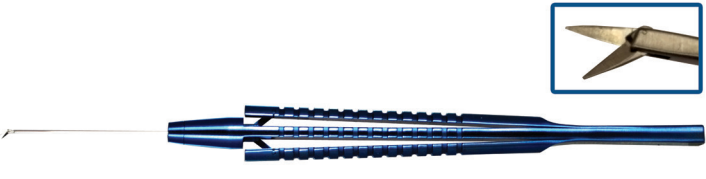

EYE SCISSORS

Item #	Description	Image
AS5140	<p><b>Eye Scissors, Curved</b></p> <p>Curved 30mm blades, sharp tips. Ring handle. Overall length: 109mm.</p>	
AS5170	<p><b>Eye Scissors, Straight</b></p> <p>Straight 30mm blades, sharp tips. Ring handle. Overall length: 109mm.</p>	

INTRAOCULAR SCISSORS

Item #	Description	Image
<b>Intraocular Scissors</b>		
Microscissors with straight tubular shafts available with straight or curved 2mm blades. All scissors have titanium, squeeze-action handles.		
AS2310	<p><b>Intraocular Scissors, Curved</b></p> <p>Curved blades. Overall length: 146mm.</p>	
AS2320	<p><b>Intraocular Scissors, Angled</b></p> <p>Angled blades. Overall length: 146mm.</p>	
AS2390	<p><b>Intraocular Scissors, Straight</b></p> <p>Straight blades. Overall length: 146mm.</p>	



**INTRAOCULAR SCISSORS**

Item #	Description	Image
AS0940	<p><b>Intraocular Scissors, Angled</b></p> <p>23g shaft, angled 45 degree blades. For cutting parallel to the retina. Overall length: 134mm.</p>	 
AS0900	<p><b>Intraocular Scissors, Straight</b></p> <p>23g shaft, straight blades. Overall length: 142mm.</p>	 







**IOL REMOVAL SCISSORS**

Item #	Description	Image
<p><b>Accutome IOL Cutter</b></p> <p>Accutome cutter for the explanting, or removal, of an IOL. Angled left 7mm blades, rounded, blunt tips. Flat handle. Overall length: 92mm.</p>		
AS0301	<p><b>Accutome IOL Cutter</b></p>	







**IRIS SCISSORS**

Item #	Description	Image
<p><b>Barraquer Iris Scissors</b></p> <p>Angled 7.5mm blades, delicate, blunt tips. Flat, squeeze-action handle. Overall length: 54mm.</p>		
AS3100	<p><b>Barraquer Iris Scissors</b></p>	
<p><b>Cohan-Vannas Curved Iris Scissors</b></p> <p>Straight 12mm blades, sharp, pointed tips. Flat, squeeze handle. Overall length: 57mm.</p>		
AS3110	<p><b>Cohan-Vannas Curved Iris Scissors</b></p>	 

IRIS SCISSORS

Item #	Description	Image
<b>DeWecker Iris Scissors</b>		
Angled 12mm blades. Flat, squeeze handle. Overall length: 114mm.		
AS3120	<b>Blunt Iris Scissors</b> Blunt tip blades.	 <p>Image showing a pair of blunt tip iris scissors with a flat, squeeze handle. An inset image shows a close-up of the blunt tips.</p>
AS3130	<b>Sharp Iris Scissors</b> Sharp and blunt tip blades.	 <p>Image showing a pair of sharp tip iris scissors with a flat, squeeze handle. An inset image shows a close-up of the sharp and blunt tips.</p>
<b>Iris Scissors</b>		
Straight and curved blades with sharp, pointed tips.		
AS3185	<b>Iris Scissors, Straight</b> Straight 10mm blades. Flat, 3-hole, squeeze handle. Overall length: 108mm.	 <p>Image showing a pair of straight iris scissors with a flat, 3-hole, squeeze handle.</p>
AS3190	<b>Iris Scissors, Straight</b> Straight 18mm blades. Ribbon handle. Overall length: 99mm.	 <p>Image showing a pair of straight iris scissors with a ribbon handle. An inset image shows a close-up of the sharp tips.</p>
AS3160	<b>Iris Scissors, Curved</b> Curved 18mm blades. Ribbon handle. Overall length: 99mm.	 <p>Image showing a pair of curved iris scissors with a ribbon handle. An inset image shows a close-up of the sharp tips.</p>
AS4110	<b>Iris Scissors, Curved</b> Curved 21mm blades. Flat, squeeze handle. Overall length: 121mm.	 <p>Image showing a pair of curved iris scissors with a flat, squeeze handle. An inset image shows a close-up of the sharp tips. The handle has "ACCUHOME USA CB" printed on it.</p>
AS4100	<b>Iris Scissors, Straight</b> Straight 21mm blades. Flat, squeeze handle. Overall length: 121mm.	 <p>Image showing a pair of straight iris scissors with a flat, squeeze handle. The handle has "AS4100" and "M2" printed on it.</p>

IRIS SCISSORS

Item #	Description	Image
AS5180	<b>Iris Scissors, Straight</b> Straight 25mm blades, light standard pattern. Ring handle. Overall length: 98mm.	
AS5150	<b>Iris Scissors, Curved</b> Curved 25mm blades, light standard pattern. Ring handle. Overall length: 98mm.	
AS3140	<b>Iris Scissors, Curved</b> Curved 25mm blades. Large ring handle. Overall length: 102mm.	
AS3170	<b>Iris Scissors, Straight</b> Straight 28mm blades. Large ring handle. Overall length: 100mm.	
AS3210	<b>Iris Scissors, Straight</b> Straight 29mm blades. Ribbon handle. Overall length: 105mm.	
AS3220	<b>Iris Scissors, Curved</b> Curved 29mm blades. Ribbon handle. Overall length: 105mm.	
AS5110	<b>Iris Scissors, Curved</b> Curved 30mm blades. Ring handle. Overall length: 108mm.	

**McPherson-Vannas Iris Scissors**

Curved 11mm blades, delicate, sharp tips. Flat, squeeze handle. Overall length: 83mm.

AS3200	<b>McPherson-Vannas Iris Scissors</b>	
--------	---------------------------------------	--

## MISCELLANEOUS SCISSORS

Item #	Description	Image
--------	-------------	-------

**Mayo Dissecting Scissors**

Straight 58mm blades, beveled, blunt tips. Ring handle. Overall length: 171mm.

AS5235	<a href="#">Mayo Dissecting Scissors</a>	
--------	--	--

**Troutman Conjunctival Scissors**

Curved 17mm blades, blunt tips. Flat, locking handle. Overall length: 107mm.

AS5910	<a href="#">Troutman Conjunctival Scissors</a>	
--------	--	--

**Westcott Conjunctival Scissors**

Lightly curved 16mm blades, blunt tips. Flat, wide, squeeze handle. Overall length: 132mm.

AS4580	<a href="#">Westcott Conjunctival Scissors</a>	
--------	--	--



## STITCH SCISSORS

Item #	Description	Image
--------	-------------	-------

**Castroviejo Mini Keratoplasty-Utility-Stitch Scissors**

Curved 13mm blades, miniature model, small, sharp, pointed tips. Flat handle, wide. Overall length: 131mm.

AS5100	<a href="#">Castroviejo Mini Keratoplasty Scissors</a>	
--------	--	--





## STITCH SCISSORS

Item #	Description	Image
--------	-------------	-------

**Fine Stitch Scissors**

Straight 17mm blades, delicate, sharp, pointed tips. Flat handle. Overall length: 112mm.

AS4120	<a href="#">Fine Stitch Scissors</a>	
--------	--------------------------------------	--

**Jaffe Stitch Scissors**

Curved blades, medium, sharp tips. Flat, 3-hole handle. Overall length: 108mm.

AS4140	<a href="#">Jaffe Stitch Scissors</a>	
--------	---------------------------------------	--

**McPherson-Westcott Stitch Scissors**

Curved, small blades, sharp, pointed tips. Flat, 3-hole handle. Overall length: 105mm.

AS4150	<a href="#">McPherson-Westcott Stitch Scissors</a>	
--------	--	--



**Stitch Scissors**

Slightly curved 13mm blades, sharp, pointed tips. Ribbon handle. Overall length: 102mm.



AS4160	<a href="#">Stitch Scissors</a>	
--------	---------------------------------	--



STITCH SCISSORS

Item #	Description	Image
<b>Westcott Type Stitch Scissors</b>		
Curved blades with sharp, pointed tips. Flat, serrated squeeze handle.		
AS4190	<b>Curved Stitch Scissors</b> Curved 21mm blades. Overall length: 116mm.	
AS4200	<b>Lightly Curved Stitch Scissors</b> Lightly curved 22mm blades. Overall length: 140mm.	

STRABISMUS SCISSORS

Item #	Description	Image
<b>Knapp Strabismus Scissors</b>		
Straight and curved blades, 25mm blades, rounded, blunt tips. Ring handle. Overall length: 118mm.		
AS3500	<b>Knapp Strabismus Scissors, Curved</b> Lightly curved blades.	
AS3510	<b>Knapp Strabismus Scissors, Curved</b> Strongly curved blades.	

**STRABISMUS SCISSORS**

Item #	Description	Image
--------	-------------	-------

AS3520 **Knapp Strabismus Scissors, Straight**  
Straight blades.



**Strabismus Scissors**

Curved and straight blades, rounded, blunt tips. Ribbon handle. Overall length: 109mm.

AS3550 **Strabismus Scissors, Straight**  
Straight 29mm blades.



AS3530 **Strabismus Scissors, Curved**  
Curved 29mm blades.



AS3540 **Strabismus Scissors, Curved**  
Strongly curved 27mm blades.



**SUTURE SCISSORS**

Item #	Description	Image
--------	-------------	-------



**Littler Suture/Dissecting Scissors**

Curved 27mm blades, holes in blades, round blunt tips. Ring handle. Overall length: 121mm.



AS5900 **Littler Dissecting Scissors**







SUTURE SCISSORS

Item #	Description	Image
<b>Stitch Removal Scissors</b>		
Straight blades with sharp tips.		
AS4170	<b>Stitch Removal Scissors, Straight</b> Straight blades, sharp tips, delicate. Ribbon handle. Overall length: 99mm.	
AS4130	<b>Stitch Removal Scissors, Straight</b> Straight 16mm blades, sharp, pointed tips. Flat, wide, squeeze handle. Overall length: 132mm.	

TENOTOMY SCISSORS

Item #	Description	Image
<b>McPherson-Westcott Tenotomy Scissors</b>		
Curved right 9mm blades, sub-miniature model, rounded, blunt tips. Flat, squeeze handle. Overall length: 88mm.		
AS0240	<b>McPherson-Westcott Tenotomy Scissors</b>	
<b>Shepard-Westcott Tenotomy Scissors</b>		
Curved right 21mm blades, blunt tips, upper blade serrated. Flat, squeeze handle. Overall length: 123mm.		
AS4510	<b>Shepard-Westcott Tenotomy Scissors</b>	

TENOTOMY SCISSORS







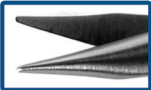

Item #	Description	Image
<b>Stevens Tenotomy Scissors</b>		
Straight and curved blades with blunt tips.		
AS4550	<p data-bbox="259 430 597 457"><b>Stevens Tenotomy Scissors, Straight</b></p> <p data-bbox="259 464 779 512">Straight 19mm blades, heavy model, blunt tips. Ring handle. Overall length: 98mm.</p>	
AS4560	<p data-bbox="259 814 597 842"><b>Stevens Tenotomy Scissors, Straight</b></p> <p data-bbox="259 848 787 896">Straight 19mm blades, light model, blunt tips. Ribbon handle. Overall length: 98mm.</p>	
AS4520	<p data-bbox="259 1199 586 1226"><b>Stevens Tenotomy Scissors, Curved</b></p> <p data-bbox="259 1232 787 1281">Curved 19mm blades, heavy model, blunt, round tips. Ribbon handle. Overall length: 98mm.</p>	
AS4530	<p data-bbox="259 1583 586 1610"><b>Stevens Tenotomy Scissors, Curved</b></p> <p data-bbox="259 1617 779 1665">Curved 19mm blades, light model, blunt tips. Ribbon handle. Overall length: 98mm.</p>	

TENOTOMY SCISSORS





Item #	Description	Image
AS4575	<p><b>Stevens Tenotomy Scissors, Curved</b></p> <p>Curved 33mm blades, blunt tips. Ring handle. Overall length: 143mm.</p>	A pair of curved tenotomy scissors with blunt tips and a ring handle. An inset image shows a close-up of the blade tips.
AS4576	<p><b>Stevens Tenotomy Scissors, Curved</b></p> <p>Curved 36mm blades, blunt tips. Ring handle. Overall length: 159mm.</p>	A pair of curved tenotomy scissors with blunt tips and a ring handle. An inset image shows a close-up of the blade tips.
AS4570	<p><b>Stevens Tenotomy Scissors, Straight</b></p> <p>Straight, standard blades 30mm from mid-screw to tips, blunt tips. Ring handle. Overall length: 112mm.</p>	A pair of straight tenotomy scissors with blunt tips and a ring handle. An inset image shows a close-up of the blade tips.
AS4540	<p><b>Stevens Tenotomy Scissors, Curved</b></p> <p>Curved, standard blades, 30mm from mid-screw to tip, blunt tips. Ring handle. Overall length: 112mm.</p>	A pair of curved tenotomy scissors with blunt tips and a ring handle. An inset image shows a close-up of the blade tips.



TENOTOMY SCISSORS

Item #	Description	Image
<b>Westcott Tenotomy Scissors</b>		
Curved left and right blades, blunt tips. Flat, squeeze handle.		
AS4590	<b>Westcott Tenotomy Scissors, Curved</b> Curved 15mm blades, medium, blunt tips. 3-hole handle. Overall length: 118mm.	 
AS4600	<b>Westcott Tenotomy Scissors, Curved Left</b> Curved left 19mm blades, rounded, blunt tips. Overall length: 115mm.	 
AS4610	<b>Westcott Tenotomy Scissors, Curved Right</b> Curved right 19mm blades, blunt tips. Overall length: 115mm.	 
AS4620	<b>Westcott Tenotomy Scissors, Curved Right</b> Curved right 23mm blades, round, blunt tips. Wide handle. Overall length: 143mm.	 

UTILITY SCISSORS

Item #	Description	Image
<b>Lister Bandage Scissors</b>		
Angled blades, probe point tip. Ring handle.		
AS6515	<b>50mm Bandage Scissors</b> 50mm blade from mid-screw to tip. Overall length: 119mm.	 
AS6516	<b>67mm Bandage Scissors</b> 67mm blade from mid-screw to tip. Overall length: 181mm.	 

UTILITY SCISSORS

Item # Description Image

Operating Scissors

Straight blades with ring handle. Overall length: 147mm.

AS5240 53mm Operating Scissors 53mm blade from mid-screw to tip, one sharp tip/blade, one blunt tip/blade.



AS6510 56mm Operating Scissors 56mm blade from mid-screw to tip, sharp tips.



Utility Scissors

25mm blades and blunt tips.

AS5190 Utility Scissors, Curved Slightly curved 18mm blades, blunt. Ribbon handle. Overall length: 99mm.



AS5220 Utility Scissors, Curved Curved 18mm blades, blunt tips. Ribbon handle. Overall length: 94mm.



AS5200 Utility Scissors, Curved Curved 25mm blades, blunt tips. Ribbon handle. Overall length: 103mm.



UTILITY SCISSORS



Item #	Description	Image
AS5250	<p><b>Utility Scissors, Angled</b></p> <p>Angled 26mm blades, probe points, blunt tips. Ring handle. Overall length: 116mm.</p>	

Westcott Type Utility Scissors

Curved 25mm blades, rounded tips, sharp. Flat handle. Overall length: 131mm.

AS5210	<p><b>Westcott Type Utility Scissors</b></p>	
--------	--	--

VANNAS SCISSORS

Item #	Description	Image
<p><b>Gills-Vannas Capsulotomy Scissors</b></p>		
<p>7mm blades, sharp, pointed tips. Flat, squeeze handle. Overall length: 89mm.</p>		
AS5510	<p><b>Gills-Vannas Capsulotomy Scissors, Angled</b></p> <p>Angled forward blades. 3-hole handle.</p>	
AS5530	<p><b>Gills-Vannas Capsulotomy Scissors, Straight</b></p> <p>Straight blades.</p>	
AS5520	<p><b>Gills-Vannas Capsulotomy Scissors, Curved</b></p> <p>Curved blades.</p>	

VANNAS SCISSORS

Item # Description Image

Gills-Welsh-Vannas Micro Scissors

Angled blades, sharp, pointed tips. Flat, squeeze handle.

AS5540 5mm Gills-Welsh-Vannas Scissors  
5mm blades. Overall length: 80mm.



AS5550 11mm Gills-Welsh-Vannas Scissors  
11mm blades. Overall length: 86mm.



Stern-Gills Scissors

Angled forward 10mm blades, extra-thin, sharp tips. Flat, 3-hole squeeze handle. Overall length: 112mm.

AS5570 Stern-Gills Scissors



Uribe-Stern Scissors

Curved forward 10mm blades, extra-thin, sharp tips. Flat, 3-hole squeeze handle. Overall length: 112mm.

AS5580 Uribe-Stern Scissors

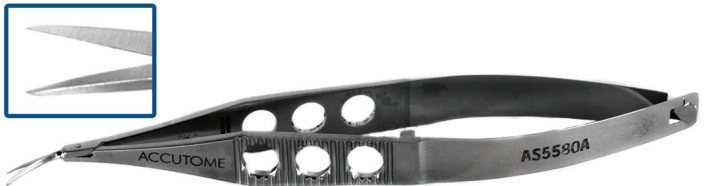

Uthoff-Gills Capsulotomy Scissors

Angled 10mm blades, curved, blunt tips. Flat, squeeze handle.

AS5590 Uthoff-Gills Capsulotomy Scissors



VANNAS SCISSORS

Item #	Description	Image
--------	-------------	-------

**Vannas Capsulotomy Scissors**

6mm blades, sharp pointed tips. Flat, squeeze handle.

AS5610	<p><b>Vannas Capsulotomy Scissors, Angled</b> 30-degree angled blades, sharp, pointed tips. Overall length: 81mm.</p>	
--------	---	--

AS5640	<p><b>Vannas Capsulotomy Scissors, Curved</b> Curved blades. Overall length: 86mm.</p>	
--------	--	--

AS5680	<p><b>Vannas Capsulotomy Scissors, Straight</b> Straight blades. Overall length: 84mm.</p>	
--------	--	--

AS5600	<p><b>Vannas Capsulotomy Scissors, Angled</b> Blades angled to side. Overall length: 81mm.</p>	
--------	--	---

**Vannas Scissors**

Curved and straight blades with extra-thin, sharp, pointed tips. Flat, 3-hole squeeze handle. Overall length: 112mm.

AS5660	<p><b>Vannas Scissors, Straight</b> Straight 7mm blades.</p>	
--------	--	--

AS5630	<p><b>Vannas Scissors, Curved</b> Curved 7mm blades.</p>	
--------	--	--

AS5670	<p><b>Vannas Scissors, Straight</b> Straight 10mm blades.</p>	
--------	---	--

VANNAS SCISSORS

Item #	Description	Image
AS5650	<b>Vannas Scissors, Curved</b> Curved 10mm blades.	



# Spatulas

The background features a dark blue gradient on the left that transitions into a lighter blue on the right. Faint, mirrored text is visible in the upper right quadrant, appearing as a reflection of the main title. A solid blue horizontal bar is positioned below the title, and a white horizontal bar is located at the bottom of the page.

CYCLODIALYSIS SPATULAS

Item #	Description	Image
--------	-------------	-------

**Barraquer Cyclodialysis Spatula**

Angled shaft, 0.5mm x 15mm angled round blade, smooth, pointed tip, slightly curved blade. Round handle. Overall length: 120mm.

AH5100	<b>Barraquer Cyclodialysis Spatula</b>	 <p>The image shows a Barraquer Cyclodialysis Spatula with a long, thin, angled shaft and a round handle. A small inset image shows a close-up of the angled blade tip.</p>
--------	--	---

**Castroviejo Cyclodialysis Spatula**

Double-ended and single-ended, angled shafts. Flat handle.

AH5140	<p><b>0.25mm Castroviejo Cyclodialysis Spatula</b>                  Double-ended, 0.25mm spatula, 10mm from bend to tip, 15mm from bend to tip. Overall length: 137mm.</p>	 <p>The image shows a double-ended Castroviejo Cyclodialysis Spatula with a textured handle. A small inset image shows a close-up of the angled blade tip.</p>
--------	--	--

AH5150	<p><b>0.5mm Castroviejo Cyclodialysis Spatula</b>                  Double-ended, 0.5mm flat posterior surface, 10mm from bend to tip, 15mm from bend to tip, semi-sharp tips. Overall length: 135mm.</p>	 <p>The image shows a double-ended Castroviejo Cyclodialysis Spatula with a textured handle. A small inset image shows a close-up of the angled blade tip.</p>
--------	--	---

AH5130	<p><b>0.75mm Castroviejo Cyclodialysis Spatula</b>                  0.75mm spatula, 10mm from bend to tip. Overall length: 134mm.</p>	 <p>The image shows a single-ended Castroviejo Cyclodialysis Spatula with a textured handle. A small inset image shows a close-up of the angled blade tip.</p>
--------	---	--

AH5120	<p><b>1.0mm Castroviejo Cyclodialysis Spatula</b>                  1.0mm spatula, 16mm from bend to tip. Overall length: 140mm.</p>	 <p>The image shows a single-ended Castroviejo Cyclodialysis Spatula with a textured handle. A small inset image shows a close-up of the angled blade tip.</p>
--------	---	--

**Castroviejo Synechia Spatula**

Double-ended, angled shafts, 0.5mm spatulas, 15mm from bend to tip, 10mm from bend to tip. Flat handle. Overall length: 133mm.

AH5160	<b>Castroviejo Synechia Spatula</b>	 <p>The image shows a double-ended Castroviejo Synechia Spatula with a textured handle.</p>
--------	-------------------------------------	---



CYCLODIALYSIS SPATULAS

Item #	Description	Image
<b>Wheeler/Elschnig Cyclo dialysis Spatula</b>		
Double-ended, curved shaft, 1.75mm spatula, 30mm from bend to tip on both ends. Flat handle. Overall length: 140mm.		
AH5370	<a href="#">Wheeler Cyclo dialysis Spatula</a>	

DSEK SPATULAS

Item #	Description	Image
<b>Cindy Sweeper DSEK Spatula</b>		
Angled shaft, 0.7mm spatula, 12mm from bend to tip, cylindrical smooth tip, blunt. Round handle. Overall length: 114mm.		
AH7201	<a href="#">Cindy Sweeper DSEK Spatula</a>	

FEMTOSECOND SPATULAS

Item #	Description	Image
<b>Eippert Femtosecond Spatula</b>		
This stainless steel Eippert Femtosecond Spatula is double-ended for greater versatility and has straight shafts with 0.9mm and 2.0mm blunt thin tips to maintain proper wound architecture. Helps to ensure open incisions after femtosecond laser incisions.		
AH4605	<a href="#">Eippert Femtosecond Spatula, Long</a> Long, round handle design that is ideal for use during femtosecond laser surgery. Overall length: 146mm.	
AH4606	<a href="#">Eippert Femtosecond Spatula, Short</a> Short, round handle design that is ideal for use with the aberrometer. Overall length: 120mm.	

FEMTOSECOND SPATULAS

Item #	Description	Image
--------	-------------	-------

**Lane Femtosecond Incisional Spatula**

Double-ended Lane femtosecond cataract incisional spatula is specifically designed for opening femtosecond-created primary, secondary, and arcuate incisions in cataract surgery. One end is used to open and spread the vertical/tangential component of the femtosecond-created incision and the other end is used to open the tunnel aspect of the incision entry into the anterior chamber. Double-ended, one-angled shaft with blunt spatulated tip, 10mm from bend to tip, max depth of 0.25mm. One straight shaft with 90-degree angle, curved spatulated tip. Round handle. Overall length: 125mm.

AH6610 Lane Femtosecond Spatula



**Lee Femtosecond Spatula**

The Lee spatula is a femtosecond cataract instrument. Flattened tip design offers benefits of opening both sideport and main incisions. A short handle allows for easy maneuvering under modern surgical abberometers. Angled shaft. Round handle. Overall length: 115mm.

AH4620 Lee Femtosecond Spatula

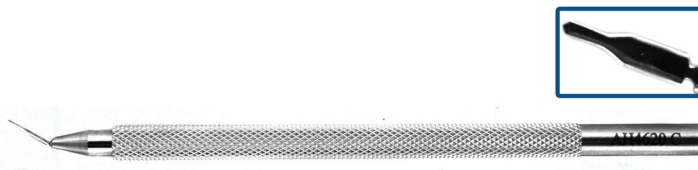

**Slade Femtosecond Laser Spatula**

Vaulted shaft, 22.0mm from bend to tip, flattened tip for opening the main and sideport incisions. Round handle. Overall length: 115mm.

AH4600 Slade Femtosecond Spatula







**Suarez Spreader**

Straight shaft, angled blade tip, 1mm x 2mm blade. Round handle. Overall length: 118mm.

AH8150 Suarez Spreader





IRIS SPATULAS

Item #	Description	Image
<b>Barraquer Iris Spatula</b>		
Angled shaft, 15mm from bend to tip, 0.5mm cylindrical smooth tip. Round handle. Overall length: 122mm.		
AH5110	<a href="#">Barraquer Iris Spatula</a>	
<b>Culler Iris Spatula</b>		
Curved shaft, 1mm wide x 28mm long spatula blade. Flat handle. Overall length: 127mm.		
AH5170	<a href="#">Culler Iris Spatula</a>	
<b>Iris Spatula</b>		
Slightly curved shafts with various size malleable blade tips.		
AH5220	<a href="#">1mm Iris Spatula</a> 1mm wide x 30mm long tip. Flat handle. Overall length: 130mm.	
AH5230	<a href="#">2mm Iris Spatula</a> 2mm wide x 33mm long tip. Round handle. Overall length: 136mm.	





LASIK SPATULAS

Item #	Description	Image
<b>Intralase Flap Lifter and Retreatment Spatula</b>		
Double-ended, angled shaft, 1.5mm from bend to tip, slightly pointed tip, spatula tip, Z-shaped tip, 12mm wide cylindrical spatula, slightly pointed tip. Round handle.		
Overall length: 106mm.		
AH5275	<a href="#">Intralase Flap Lifter and Retreatment Spatula</a>	

LASIK SPATULAS

Item #	Description	Image
<b>Katzen LASIK Flap "Unzipper"</b>		
Double-ended, straight shafts, modified sinskey hook, bi-convex spatula, beveled notches. Round handle. Overall length: 133mm.		
AH1000	<a href="#">Katzen LASIK Flap</a>	 

PHACO SPATULAS

Item #	Description	Image
<b>Gimbel Nucleus Spatula</b>		
Angled 30-degree shaft, 9mm from bend to tip, 0.25mm diameter, smooth. Round handle. Overall length: 121mm.		
AH5190	<a href="#">Gimbel Nucleus Spatula</a>	
<b>Jaffe Lens Spatula</b>		
Angled shaft, 10mm from bend to tip, 0.5mm wide, flat spatula. Flat handle. Overall length: 114mm.		
AH5240	<a href="#">Jaffe Lens Spatula</a>	
<b>Johnson Spatula</b>		
Angled shaft, 10mm from bend to tip, 0.25mm wide blunt blade tip. Round handle. Overall length: 105mm.		
AH5500	<a href="#">Johnson Spatula</a>	
<b>Knolle Lens Nucleus Spatula and Anterior Chamber Gauge</b>		
Curved shaft, flat spatula blade, 30mm long blade, marks at 5mm, 6mm, and 7mm from tip. Round handle. Overall length: 126mm.		
AH5260	<a href="#">Knolle Spatula and Chamber Gauge</a>	



PHACO SPATULAS

Item #	Description	Image
--------	-------------	-------

**Knolle Nucleus Spatula**

Straight shaft, 0.5mm wide tip, malleable. Round handle. Overall length: 127mm.

AH5265 [Knolle Nucleus Spatula](#)



**Koch Nucleus Spatula**

Curved shaft, 1mm wide, duckbill-shaped tip. Round handle. Overall length: 115mm.

AH5256 [Koch Nucleus Spatula, Smooth](#)  
1mm wide tip.



AH5255 [Koch II-Nucleus Spatula, Notched](#)  
1mm wide tip with notches.

**Koch Phacoemulsification Spatula**

Curved shaft, duckbill-shaped spatula tip, 0.8mm wide tip. Round handle. Overall length: 117mm.

AH5267 [Koch Phacoemulsification Spatula](#)



**Lieppman Nucleus Spatula**

Angled shaft, forked tip, 0.5mm wide, blunt tip. Round handle. Overall length: 121mm.

AH5270 [Lippman Nucleus Spatula](#)



**Rowen Phaco Spatula**

Double-ended, angled shafts, 9mm from bend to tip, phaco splitter, 60-degree interior cutting edge, blunt tip, 7mm from bend to tip, nucleus rotator, Y-shaped tip. Round handle. Overall length: 143mm.

AH5355 [Rowen Phaco Spatula](#)



REFRACTIVE SPATULAS

Item #	Description	Image
--------	-------------	-------

**Kimura Platinum Spatula**

Straight shaft, 34mm shaft, 4mm wide x 17.5mm flat platinum spatula. Flat handle. Overall length: 149mm.

AH5250	<a href="#">Kimura Platinum Spatula</a>	



**Maloney PRK Spatula**

Angled shaft, 5mm from bend to tip, 2mm wide spatula tip, semi-sharp. Round handle. Overall length: 120mm.

AH5390	<a href="#">Maloney PRK Spatula</a>	

**Paton Spatula and Spoon**

Double-ended, angled shaft, 8mm from bend to tip, 1.5mm flat spatula, curved 6mm teardrop-shaped spoon with three long openings. Flat handle. Overall length: 140mm.

AH6140	<a href="#">Paton Spatula and Spoon</a>	

RETINAL SPATULAS

Item #	Description	Image
--------	-------------	-------

**Maumenee-Barraquer Vitreous Sweep Spatula**

Angled shaft, 11mm from bend to tip, spatula blade tip. Round handle. Overall length: 120mm.





AH5124	<a href="#">Maumenee-Barraquer Spatula, Right</a> Right-hand use.	
AH5125	<a href="#">Maumenee-Barraquer Spatula, Left</a> Left-hand use.	







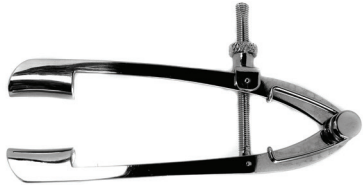

# Speculums

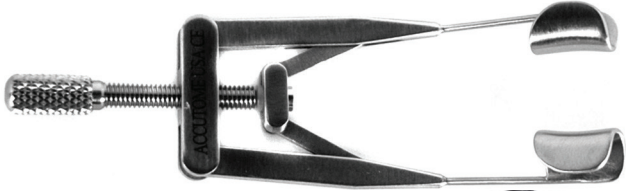

## ADJUSTABLE SPECULUMS

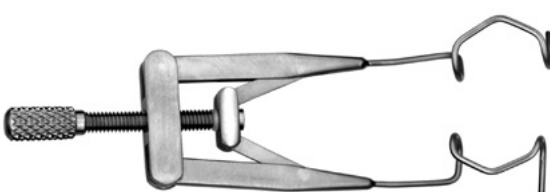
Item #	Description	Image
<b>Cook Eye Speculum</b>		
Pediatric size, 10mm solid round blades, 22mm blade spread, temporal approach, locking screw mechanism. Overall length: 57mm.		
AL0340	<a href="#">Cook Eye Speculum</a>	
<b>Kammann Eye Speculum</b>		
Adult size, 16mm closed K-wire fenestrated blades, self-locking mechanism, 27mm blade spread, temporal approach. Overall length: 70mm.		
AL0450	<a href="#">Kammann Eye Speculum</a>	
<b>Lancaster Eye Speculum</b>		
Adult size, 15mm round solid blades, 35mm blade spread that is spring-controlled with locking mechanism, temporal approach. Overall length: 69mm.		
AL0390	<a href="#">Lancaster Eye Speculum</a>	
<b>Lester-Burch Eye Speculum</b>		
Adult size, 21mm round solid blades, 32mm blade spread, temporal approach, locking screw mechanism. Overall length: 82mm.		
AL0400	<a href="#">Lester-Burch Eye Speculum</a>	

## ADJUSTABLE SPECULUMS

Item #	Description	Image
<b>Lieberman Adjustable Speculum</b>		
Adult and pediatric size Lieberman adjustable speculums available in various blade sizes. The options of titanium or stainless steel with temporal, nasal, and reversible approaches are available. Lid tension is adjustable with thumb-screw control.		
AL0521 S	<b>Round, Solid Speculum</b> Pediatric size, 10mm round solid blades, temporal approach. Overall length: 73mm.	
AL0520 S	<b>Round, Solid Speculum</b> Adult size, 14mm round solid blades, reversible approach. Overall length: 90mm.	
AL0520 N/K	<b>K-Wire Speculum</b> Adult size, 14mm square open K-wire blades, nasal approach. Overall length: 83mm.	
AL0520 N/V	<b>V-Wire Speculum</b> Adult size, 14mm open V-wire blades with no flare, nasal approach. Overall length: 83mm.	
AL0520 T/K	<b>K-Wire Speculum</b> Adult size, 15mm open K-wire blades, temporal approach. Overall length: 90mm.	
AL0520 T/K TI	<b>K-Wire Speculum</b> Adult size, titanium, 15mm open K-wire blades, temporal approach. Overall length: 90mm.	
AL0520 T/V	<b>V-Wire Speculum</b> Adult size, 15mm open V-wire blades, temporal approach. Overall length: 90mm.	
AL0520 T/V TI	<b>V-Wire Speculum</b> Adult size, titanium, 15mm V-wire blades, temporal approach. Overall length: 90mm.	

ADJUSTABLE SPECULUMS

Item #	Description	Image
AL0523 T/K	<p><b>K-Wire Speculum</b></p> <p>Designed for use during femtosecond cataract surgery. Adult size, 15mm open K-wire blades, temporal approach. Blades are covered in silicone tubing for patient comfort as well as for pushing back the conjunctiva. Overall length: 85mm.</p>	
AL0523 T/V	<p><b>V-Wire Speculum</b></p> <p>Designed for use during femtosecond cataract surgery. Adult size, 15mm open V-wire blades, temporal approach. Blades are covered in silicone tubing for patient comfort as well as for pushing back the conjunctiva. Overall length: 85mm.</p>	
AL0525	<p><b>Round, Solid Speculum</b></p> <p>Adult size, 15mm round solid, thin blades, temporal approach. Overall length: 76mm.</p>	

**Schott Eye Speculum**

Adult size, 16mm round closed wire blades, temporal approach, rotatable adjustment for control of blade elevation. Overall length: 140mm.

AL0480	<p><b>Schott Eye Speculum</b></p>	
--------	-----------------------------------	--

**Williams Eye Speculum**

Both adult and pediatric sizes are available in this Williams Eye Speculum. Various blade sizes and spread that are temporal in approach. Comes with a spring-controlled blade spread with screw-type locking mechanism.

AL0490	<p><b>Adult Eye Speculum</b></p> <p>Adult size, 14mm closed K-wire blades, 52mm blade spread. Overall length: 86mm.</p>	
AL0500	<p><b>Pediatric Eye Speculum</b></p> <p>Pediatric size, 11mm closed K-wire blades, 41mm blade spread. Overall length: 69mm.</p>	



**ASPIRATING SPECULUMS**

Item #	Description	Image
--------	-------------	-------

**Lieberman Aspirating Speculum**

Adult size, 12mm open K-wire blades, temporal approach, lid tension adjustable with thumb-screw control, supplied with silicone tubing and luer-lock adapter. Overall length: 82mm.

AL0530	<a href="#">Lieberman Aspirating Speculum</a>
--------	---



**Machat LASIK Speculum**

Aspirating and non-aspirating Machat LASIK speculums. Both are adult size with 17mm open V-wire blades, temporal approach, and have thumb-screw control for lid tension. Overall length: 76mm.

AL0533	<a href="#">Machat Aspirating Speculum</a> Aspirating speculum.
--------	--



AL0534	<a href="#">Machat Adjustable Speculum</a> Non-aspirating speculum.
--------	--

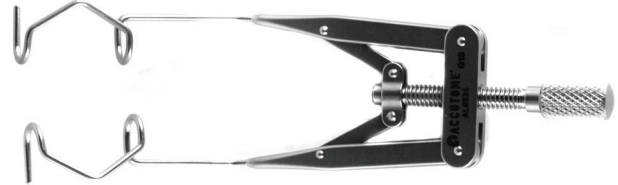

**WIRE SPECULUMS**

Item #	Description	Image
--------	-------------	-------

**Varley LASIK/Femtosecond Lid Speculum**

Adult size, 14mm open K-wire blades with modified bent shafts, 0.039 stainless steel wire, 30mm blade spread, temporal approach. Overall length: 60mm.

AL3190	<a href="#">Varley LASIK/Femtosecond Lid Speculum</a>
--------	---

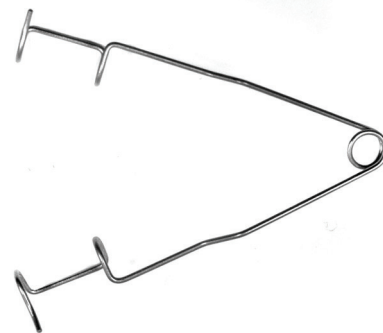

## WIRE SPECULUMS

Item #	Description	Image
--------	-------------	-------

**Alfonso Eye Speculum**

Newborn size speculums available in both regular wire and heavy wire. 5mm closed K-wire blades with 27mm spread, temporal approach. Dull finish. Overall length: 45mm.

AL0300	<b>Wire Newborn Speculum</b>	
--------	------------------------------	--

Standard wire.

AL0301	<b>Heavy Wire Newborn Speculum</b>	
--------	------------------------------------	--

Heavy wire.

**Barraquer Lid Speculum**

A variety of Barraquer eye speculums in both adult and pediatric sizes. Solid, closed, and open blades that are both temporal and nasal in approach are available.





AL0190	<b>K-Wire Speculum</b>	
--------	------------------------	---

Infant size, 4mm open K-wire blades, 15mm blade spread, temporal approach. Overall length: 31mm.

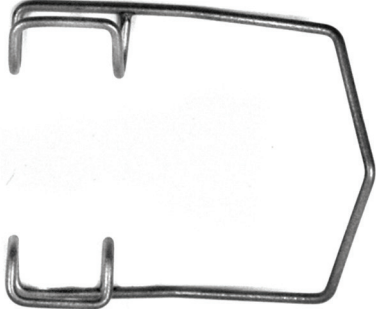

AL0141	<b>K-Wire Speculum</b>	
--------	------------------------	--

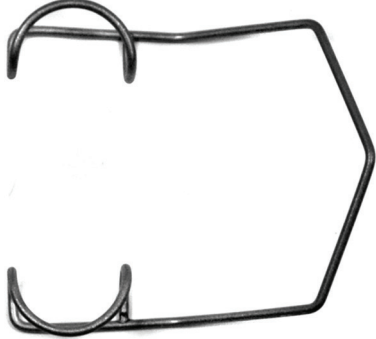
Pediatric size, 8mm closed K-wire blades, 15mm blade spread, temporal approach. Overall length: 32mm.

## WIRE SPECULUMS

Item #	Description	Image
AL0145 H	<p data-bbox="256 317 418 344"><b>K-Wire Speculum</b></p> <p data-bbox="256 352 781 401">Pediatric size, 9mm heavy closed K-wire blades, 11mm blade spread, temporal approach. Overall length: 30mm.</p>	
AL0100	<p data-bbox="256 701 472 728"><b>Round, Solid Speculum</b></p> <p data-bbox="256 737 781 785">Pediatric size, 10mm round solid blades, 15mm blade spread, temporal approach. Overall length: 38mm.</p>	
AL0140	<p data-bbox="256 1083 467 1110"><b>Round, Wire Speculum</b></p> <p data-bbox="256 1119 781 1167">Pediatric size, 11mm round closed wire blades, 15mm blade spread, temporal approach. Overall length: 38mm.</p>	
AL0140S	<p data-bbox="256 1465 418 1493"><b>K-Wire Speculum</b></p> <p data-bbox="256 1501 781 1549">Pediatric size, 11mm closed K-wire blades, square, 19mm blade spread, temporal approach. Overall length: 35mm.</p>	

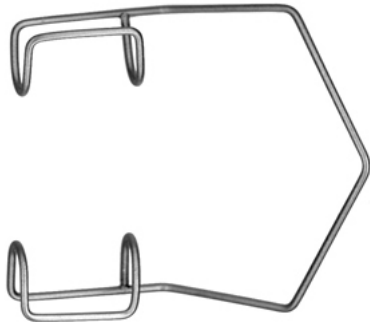
## WIRE SPECULUMS

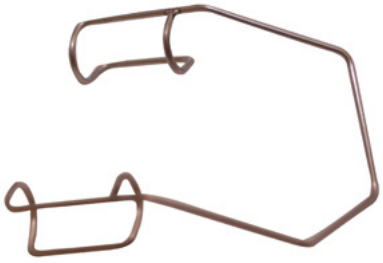
Item #	Description	Image
AL0121 S	<p data-bbox="261 321 418 342"><b>K-Wire Speculum</b></p> <p data-bbox="261 354 776 401">Adult size, 12mm closed K-wire blades, 18mm blade spread, temporal approach. Overall length: 32mm.</p>	 <p>A wire speculum with two curved blades made of thin wire. The blades are closed and have a hook-like shape at their tips. The speculum is shown from a side-on perspective, highlighting its overall shape and the arrangement of the blades.</p>
AL0110	<p data-bbox="261 703 472 724"><b>Round, Solid Speculum</b></p> <p data-bbox="261 737 776 783">Adult size, 14mm solid rounded blades, 18mm blade spread, temporal approach. Overall length: 41mm.</p>	 <p>A solid metal speculum with two rounded blades. The blades are thick and have a smooth, polished finish. The speculum is shown from a side-on perspective, highlighting its solid construction and the rounded shape of the blades.</p>
AL0120	<p data-bbox="261 1087 467 1108"><b>Round, Wire Speculum</b></p> <p data-bbox="261 1117 743 1167">Adult size, 14mm round closed wire blades, 18mm blade spread, temporal approach. Overall length: 38mm.</p>	 <p>A wire speculum with two rounded blades made of thin wire. The blades are closed and have a smooth, rounded tip. The speculum is shown from a side-on perspective, highlighting its wire construction and the rounded shape of the blades.</p>
AL0120 S	<p data-bbox="261 1472 418 1493"><b>K-Wire Speculum</b></p> <p data-bbox="261 1501 776 1551">Adult size, 14mm closed K-wire blades, 18mm blade spread, temporal approach. Overall length: 38mm.</p>	 <p>A wire speculum with two curved blades made of thin wire. The blades are closed and have a hook-like shape at their tips. The speculum is shown from a side-on perspective, highlighting its overall shape and the arrangement of the blades.</p>

## WIRE SPECULUMS

Item #	Description	Image
AL0126	<b>K-Wire Speculum</b> Adult size, 14mm closed K-wire blades, 18mm blade spread, nasal approach. Overall length: 38mm.	A wire speculum with two closed K-wire blades. The blades are positioned to provide a nasal approach. The overall length is 38mm.
AL0130	<b>K-Wire Speculum</b> Adult size, 14mm closed K-wire blades, heavy wire, 18mm blade spread, temporal approach. Overall length: 38mm.	A wire speculum with two closed K-wire blades. The blades are positioned to provide a temporal approach. The overall length is 38mm.
AL0180	<b>Round, Wire Speculum</b> Adult size, 14mm round closed wire blades, 18mm blade spread, temporal approach. Overall length 38mm.	A wire speculum with two round closed wire blades. The blades are positioned to provide a temporal approach. The overall length is 38mm.
AL0143	<b>Round, Solid Speculum</b> Pediatric size, 14mm solid round blades, 18mm blade spread, temporal approach. Dull finish. Overall length: 41mm.	A solid metal speculum with two round blades. The blades are positioned to provide a temporal approach. The overall length is 41mm.

WIRE SPECULUMS

Item #	Description	Image
--------	-------------	-------

**Floyd-Barraquer Eye Speculum**

Adult size, 14mm closed round wire blades with 6mm lifting wings, 18mm blade spread, temporal approach. Overall length: 40mm.

AL0133	<a href="#">Floyd-Barraquer Eye Speculum</a>	
--------	--	---

**Kratz-Barraquer Eye Speculum**

Adult and pediatric sizes with open K-wire blades and temporal approach.

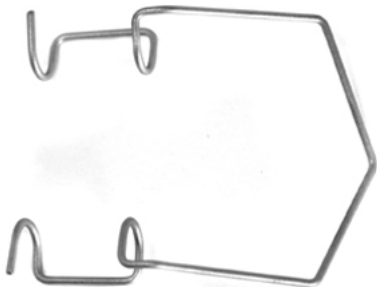
AL0160	<p><a href="#">10mm Eye Speculum</a></p> <p>Pediatric size, 10mm blades, 19mm blade spread, temporal approach. Overall length: 35mm.</p>	
--------	--	---

AL0150	<p><a href="#">14mm Eye Speculum</a></p> <p>Adult size, 14mm blades, 18mm blade spread, temporal approach. Overall length: 41mm.</p>
--------	--

AL0165	<p><a href="#">14mm Eye Speculum</a></p> <p>Adult size, 14mm heavy wire blades, 18mm blade spread, temporal approach. Overall length: 38mm.</p>
--------	---

**Kratz-Nichamin Lid Speculum**

Adult size, 16mm open K-wire blades, temporal approach, wing tip twist that gives the surgeon better on-axis accessibility. Overall length: 45mm.

AL0151	<a href="#">Kratz-Nichamin Lid Speculum</a>	
--------	---	--



## WIRE SPECULUMS

Item #	Description	Image
--------	-------------	-------

**Lehner Lid Speculum**

Adult size, 14mm open K-wire blades, heavy wire, 18mm blade spread, temporal approach, angled up 45 degrees. Overall length: 38mm.

AL0153	<a href="#">Lehner Lid Speculum</a>	
--------	-------------------------------------	--

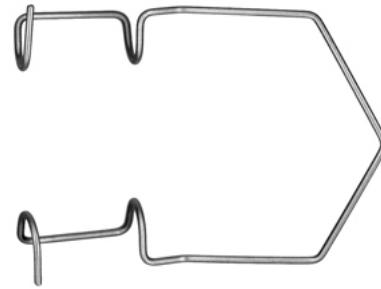
**Sauer Eye Speculum**

Infant size, 8mm round solid blades, 22mm blade spread, temporal approach. Overall length: 34mm.

AL0470	<a href="#">Infant Sauer Eye Speculum</a>	
--------	---	--

**Slade Refractive Speculum**

Adult size, 0.035 stainless steel wire, 15mm round open wire blades with flared tips. Temporal approach. Overall length: 41mm.

AL0175	<a href="#">Slade Refractive Wire Speculum</a>	
--------	--	--

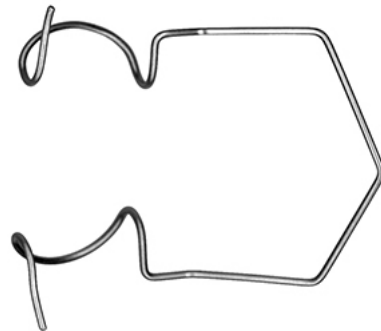

## WIRE SPECULUMS

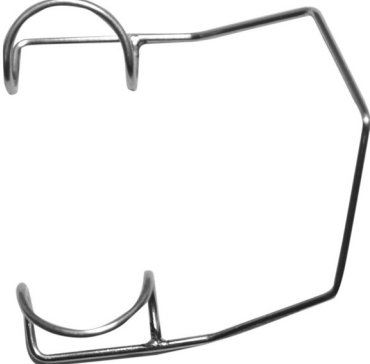
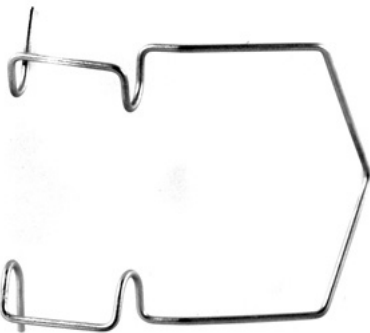
Item #	Description	Image
<b>Temporal Approach Wire Speculum</b>		
Adult size wire speculums with temporal approach. K-wire or round blade options with 18mm blade spread in stainless steel.		
AL0152	<b>Round Temporal Speculum</b> 14mm round closed blades. Overall length: 41mm.	 A wire speculum with two rounded blades. The blades are closed and meet at a point. The overall shape is roughly rectangular with rounded corners and a small hook-like extension on the top blade.
AL0185	<b>Square Temporal Speculum</b> 14mm open K-wire blades. Overall length: 38mm.	 A wire speculum with two open K-wire blades. The blades are open and form a square shape. The overall shape is roughly rectangular with rounded corners and a small hook-like extension on the top blade.

# Spoons

The background features a dark blue gradient with a subtle, mirrored pattern of the word 'SPOONS' in a light blue, sans-serif font. A solid blue horizontal bar is positioned below the title, and a white gradient bar is located at the bottom of the page.

## EVISCERATION &amp; ENUCLEATION SPOONS

Item #	Description	Image
<b>Bunge Evisceration Spoon</b>		
Straight shaft, spoon blade, flat, smooth. Flat handle.		
AH6120	<b>8mm Bunge Evisceration Spoon</b> 8mm diameter spoon blade. Overall length: 136mm.	
AH6110	<b>12mm Bunge Evisceration Spoon</b> 12mm diameter spoon blade. Overall length: 140mm.	

**Wells Enucleation Spoon**

Straight shaft, curved spoon tip, 21mm wide spoon, 5mm wide x 10mm long notch in spoon. Flat handle. Overall length: 147mm.



AH6150	<b>Wells Enucleation Spoon</b>	
--------	--------------------------------	--

## LENS SPOONS

Item #	Description	Image
<b>Culler Lens Spoon</b>		
Straight shaft, spoon-shaped tip, 5mm wide x 9mm long tip, solid middle. Flat handle. Overall length: 137mm.		
AH6130	<b>Culler Lens Spoon</b>	



# Sterilization Trays

## METAL TRAYS

Item #	Description	Image
<b>Metal Microsurgical Instrument Sterilization Tray</b>		
Aluminum metal microsurgical instrument sterilization trays with hinged lids. Available in various sizes and comes as a single or double layer.		
AT0242	<p data-bbox="261 428 456 449"><b>Two-Layer Metal Tray</b></p> <p data-bbox="261 464 786 512">Two layers with pin mat and retainers. External size: 10.5"W x 10.5"L x 2.5"H. Internal size: 9.84"W x 10.2"L x 2.32"H.</p>	
AT0281	<p data-bbox="261 814 456 835"><b>Two-Layer Metal Tray</b></p> <p data-bbox="261 850 786 919">Two layers with pin mat, retainers, short tray, and full-height accessory area. External size: 15"W x 10.5"L x 2.5"H. Internal size: 9.84"W x 14.60"L x 2.32"H.</p>	
AT0241	<p data-bbox="261 1192 477 1213"><b>Single-Layer Metal Tray</b></p> <p data-bbox="261 1228 786 1276">Single layer with pin mat and retainers. External size: 10.5"W x 10.5"L x 1.5"H. Internal size: 9.84"W x 10.2"L x 1.23"H.</p>	

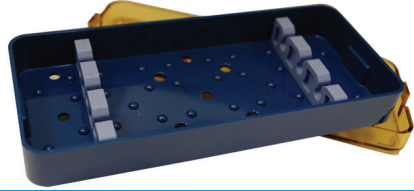

PLASTIC TRAYS

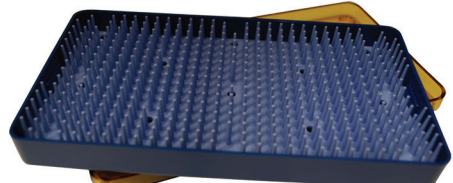
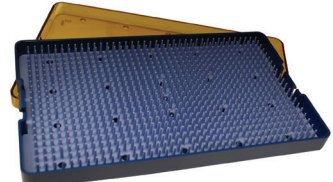
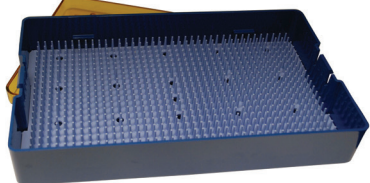
Item #	Description	Image
<b>Diamond Knife Tray</b>		
Plastic single-layer tray. Includes base, lid, and holder for up to three knives. Loose lid. Small size - 2.5"W x 6"L x 0.75"H.		
AT0200	<a href="#">Diamond Knife Tray</a>	
<b>Plastic Microsurgical Instrument Sterilization Tray</b>		
Various plastic microsurgical trays used for instrument sterilization with lid and silicone finger mats. Comes in a variety of different sizes. Loose lid.		
AT0155	<p data-bbox="261 732 574 762"><a href="#">Accutome Sterilization Tray, Small</a></p> <p data-bbox="261 768 797 816">Plastic single-layer tray. Includes base, lid, and silicone finger mat. Small size - 4"W x 7.5"L x 1.5"H.</p>	
AT0210	<p data-bbox="261 1115 574 1144"><a href="#">Accutome Sterilization Tray, Small</a></p> <p data-bbox="261 1150 797 1199">Plastic single-layer tray. Includes base, lid, and silicone finger mat. Small size - 2.5"W x 6"L x 0.75"H.</p>	
AT0225	<p data-bbox="261 1308 574 1337"><a href="#">Accutome Sterilization Tray, Small</a></p> <p data-bbox="261 1344 797 1392">Plastic single-layer tray. Includes base, lid, and silicone finger mat. Small size - 4"W x 7.5"L x 0.75"H.</p>	
AT0190	<p data-bbox="261 1497 596 1526"><a href="#">Accutome Sterilization Tray, Medium</a></p> <p data-bbox="261 1533 797 1581">Plastic single-layer tray. Includes base, lid, and silicone finger mat. Medium size - 6"W x 10"L x 0.75"H.</p>	
AT0195	<p data-bbox="261 1692 596 1722"><a href="#">Accutome Sterilization Tray, Medium</a></p> <p data-bbox="261 1728 797 1776">Plastic single-layer tray. Includes deep base, lid, and silicone finger mat. Medium size - 6"W x 10"L x 1.5"H.</p>	

## PLASTIC TRAYS

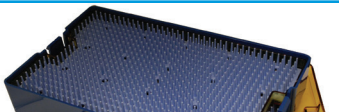
Item #	Description	Image
AT0170	<p><b>Accutome Sterilization Tray, Medium</b></p> <p>Plastic double-layer tray. Includes extra-deep base, insert tray, lid, and two silicone finger mats. Medium size - 6"W x 10"L x 1.5"H.</p>	

AT0160	<p><b>Accutome Sterilization Tray, Large</b></p> <p>Plastic single-layer tray. Includes base, lid, and silicone finger mat. Large size - 10"W x 15"L x 0.75"H.</p>
--------	--



## Plastic Phaco Instrument Sterilization Tray

Plastic Phaco single-layer instrument sterilization trays come with a base, lid, bars, and slots. Loose lid.

AT0600	<p><b>1-Slot Phaco Tray</b></p> <p>Includes base, lid, 2 bars, and 1 slot. Medium size - 6"W x 10"L x 1.5"H.</p>
--------	--

AT0601	<p><b>3-Slot Phaco Tray</b></p> <p>Includes base, lid, 2 bars, and 3 slots. Medium size - 6"W x 10"L x 1.5"H.</p>
--------	---



## Sterilization Tray Replacement Mat

Silicone finger mat for use in Accutome medium sterilization tray (AT0170). Light blue in color and has perforated bottom for draining. Medium size - 6"W x 10"L.

AT0170 BTTM MAT	<b>Sterilization Tray Replacement Mat</b>
-----------------	---

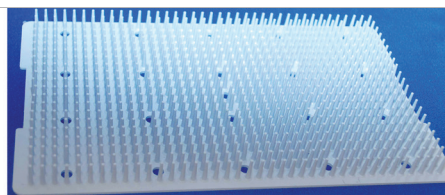

# Trephines & Punches

DISPOSABLE TREPHINES & PUNCHES

Item #	Description	Image
--------	-------------	-------

**Disposable Radial Vacuum Trephine**

Our sterile, single-use vacuum trephines consistently create accurate and uniform cuts by dividing the corneal chamber into 16 chambers, thus reducing corneal distortion. The ergonomic grip allows for easier control while making precision cuts on patient corneas. 16 radial marks allow for easy suture placement. Sold individually.

AB-67600	<b>6.00mm Disposable Trephine</b> 6.00mm diameter.
AB-67650	<b>6.50mm Disposable Trephine</b> 6.50mm diameter.
AB-67700	<b>7.00mm Disposable Trephine</b> 7.00mm diameter.
AB-67725	<b>7.25mm Disposable Trephine</b> 7.25mm diameter.
AB-67750	<b>7.50mm Disposable Trephine</b> 7.50mm diameter.
AB-67775	<b>7.75mm Disposable Trephine</b> 7.75mm diameter.
AB-67800	<b>8.00mm Disposable Trephine</b> 8.00mm diameter.
AB-67825	<b>8.25mm Disposable Trephine</b> 8.25mm diameter.
AB-67850	<b>8.50mm Disposable Trephine</b> 8.50mm diameter.
AB-67875	<b>8.75mm Disposable Trephine</b> 8.75mm diameter.
AB-67900	<b>9.00mm Disposable Trephine</b> 9.00mm diameter.

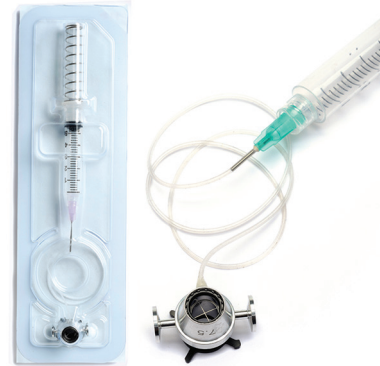

**Vacuum Donor Punch**

Our sterile, single-use vacuum donor punches have an ultra-sharp cutting blade for making precision cuts of the donor tissue for corneal transplants. The punches feature four guide posts that ensure proper alignment. Sold individually.

AB-60600	<b>6.00mm Disposable Punch</b> 6.00mm diameter.
AB-60625	<b>6.25mm Disposable Punch</b> 6.25mm diameter.
AB-60650	<b>6.50mm Disposable Punch</b> 6.50mm diameter.
AB-60675	<b>6.75mm Disposable Punch</b> 6.75mm diameter.
AB-60700	<b>7.00mm Disposable Punch</b> 7.00mm diameter.
AB-60725	<b>7.25mm Disposable Punch</b> 7.25mm diameter.
AB-60750	<b>7.50mm Disposable Punch</b> 7.50mm diameter.



## DISPOSABLE TREPINES &amp; PUNCHES

Item #	Description	Image
AB-60775	<b>7.75mm Disposable Punch</b> 7.75mm diameter.	
AB-60785	<b>7.85mm Disposable Punch</b> 7.85mm diameter.	
AB-60800	<b>8.00mm Disposable Punch</b> 8.00mm diameter.	
AB-60825	<b>8.25mm Disposable Punch</b> 8.25mm diameter.	
AB-60850	<b>8.50mm Disposable Punch</b> 8.50mm diameter.	
AB-60875	<b>8.75mm Disposable Punch</b> 8.75mm diameter.	
AB-60900	<b>9.00mm Disposable Punch</b> 9.00mm diameter.	
AB-60925	<b>9.25mm Disposable Punch</b> 9.25mm diameter.	
AB-60950	<b>9.50mm Disposable Punch</b> 9.50mm diameter.	

## REUSABLE TREPINES &amp; PUNCHES

Item #	Description	Image
<b>Long Reusable Trephine Blade</b>		
Stainless steel, long, reusable trephine blades range in diameter from 2mm to 16mm. All blades are 15mm in length and are sold individually.		
AM0570 20	<b>2mm Long Trephine</b> 2mm diameter blade tip.	
AM0570 25	<b>2.5mm Long Trephine</b> 2.5mm diameter blade tip.	
AM0570 30	<b>3mm Long Trephine</b> 3mm diameter blade tip.	
AM0570 40	<b>4mm Long Trephine</b> 4mm diameter blade tip.	
AM0570 45	<b>4.5mm Long Trephine</b> 4.5mm diameter blade tip.	
AM0570 50	<b>5mm Long Trephine</b> 5mm diameter blade tip.	
AM0570 60	<b>6mm Long Trephine</b> 6mm diameter blade tip.	
AM0570 65	<b>6.5mm Long Trephine</b> 6.5mm diameter blade tip.	
AM0570 67	<b>6.75mm Long Trephine</b> 6.75mm diameter blade tip.	

REUSABLE TREPHINES & PUNCHES

Item #	Description	Image
AM0570 70	<b>7mm Long Trephine</b> 7mm diameter blade tip.	
AM0570 72	<b>7.25mm Long Trephine</b> 7.25mm diameter blade tip.	
AM0570 75	<b>7.5mm Long Trephine</b> 7.5mm diameter blade tip.	
AM0570 77	<b>7.75mm Long Trephine</b> 7.75mm diameter blade tip.	
AM0570 80	<b>8mm Long Trephine</b> 8mm diameter blade tip.	
AM0570 82	<b>8.25mm Long Trephine</b> 8.25mm diameter blade tip.	
AM0570 85	<b>8.5mm Long Trephine</b> 8.5mm diameter blade tip.	
AM0570 87	<b>8.75mm Long Trephine</b> 8.75mm diameter blade tip.	
AM0570 90	<b>9mm Long Trephine</b> 9mm diameter blade tip.	
AM0570 95	<b>9.5mm Long Trephine</b> 9.5mm diameter blade tip.	
AM0570 100	<b>10mm Long Trephine</b> 10mm diameter blade tip.	
AM0570 105	<b>10.5mm Long Trephine</b> 10.5mm diameter blade tip.	
AM0570 110	<b>11mm Long Trephine</b> 11mm diameter blade tip.	
AM0570 115	<b>11.5mm Long Trephine</b> 11.5mm diameter blade tip.	
AM0570 140	<b>14mm Long Trephine</b> 14mm diameter blade tip.	
AM0570 15	<b>15mm Long Trephine</b> 15mm diameter blade tip.	
AM0570 160	<b>16mm Long Trephine</b> 16mm diameter blade tip.	



## REUSABLE TREPHINES &amp; PUNCHES

Item #	Description	Image
<b>Universal Trephine Blade Holder</b>	Stainless steel, adjustable fingerlike tips that rest in the grooved disposable trephine blades, fits 3mm to 10mm short and long trephine blades. Round handle with screw-type adjustable spread. Overall length: 49mm.	 A black, cylindrical metal tool with a textured grip and a central opening for a trephine blade. It has a screw-type adjustable spread mechanism at the top.
AM0510	<a href="#">Universal Trephine Blade Holder</a>	



# Sutures



NYLON

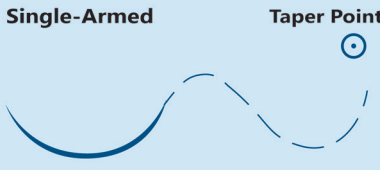
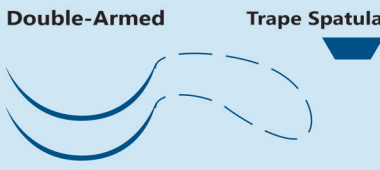
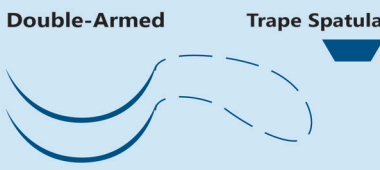
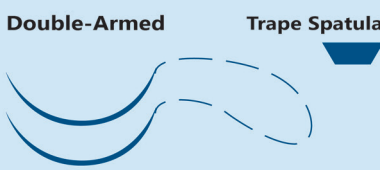
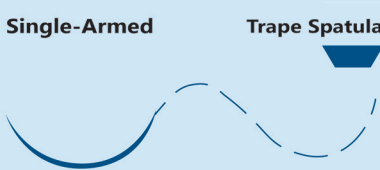
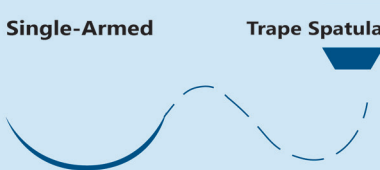





Item #	Description	Image																
<b>Sutures 11-0 Nylon</b>																		
AB-0550S	<p><b>Nylon Suture, Taper Point</b></p> <p>Single-armed suture, measures 13cm in length. Taper point needle, measures 4.0mm in length, 3/8 curve, and 0.05mm in diameter.</p>	 <table border="1"> <thead> <tr> <th colspan="2">Suture</th> </tr> </thead> <tbody> <tr> <td>Description</td> <td>Nylon, Black Mono</td> </tr> <tr> <td>Length (cm)</td> <td>13</td> </tr> <tr> <td>Size</td> <td>11-0 (0.1 metric)</td> </tr> </tbody> </table> <table border="1"> <thead> <tr> <th colspan="2">Needle</th> </tr> </thead> <tbody> <tr> <td>Length (mm)</td> <td>4.0</td> </tr> <tr> <td>Curve</td> <td>3/8</td> </tr> <tr> <td>Diam. (mm)</td> <td>0.05</td> </tr> </tbody> </table>	Suture		Description	Nylon, Black Mono	Length (cm)	13	Size	11-0 (0.1 metric)	Needle		Length (mm)	4.0	Curve	3/8	Diam. (mm)	0.05
Suture																		
Description	Nylon, Black Mono																	
Length (cm)	13																	
Size	11-0 (0.1 metric)																	
Needle																		
Length (mm)	4.0																	
Curve	3/8																	
Diam. (mm)	0.05																	
AB-1476	<p><b>Nylon Suture, Trape Spatula</b></p> <p>Double-armed suture, measures 30cm in length. Trape spatula needle, measures 5.5mm in length, 7/16 curve, and 0.14mm in diameter.</p>	 <table border="1"> <thead> <tr> <th colspan="2">Suture</th> </tr> </thead> <tbody> <tr> <td>Description</td> <td>Nylon, Black Mono</td> </tr> <tr> <td>Length (cm)</td> <td>30</td> </tr> <tr> <td>Size</td> <td>11-0 (0.1 metric)</td> </tr> </tbody> </table> <table border="1"> <thead> <tr> <th colspan="2">Needle</th> </tr> </thead> <tbody> <tr> <td>Length (mm)</td> <td>5.5</td> </tr> <tr> <td>Curve</td> <td>7/16</td> </tr> <tr> <td>Diam. (mm)</td> <td>0.14</td> </tr> </tbody> </table>	Suture		Description	Nylon, Black Mono	Length (cm)	30	Size	11-0 (0.1 metric)	Needle		Length (mm)	5.5	Curve	7/16	Diam. (mm)	0.14
Suture																		
Description	Nylon, Black Mono																	
Length (cm)	30																	
Size	11-0 (0.1 metric)																	
Needle																		
Length (mm)	5.5																	
Curve	7/16																	
Diam. (mm)	0.14																	
AB-1403	<p><b>Nylon Suture, Trape Spatula</b></p> <p>Double-armed suture, measures 20cm in length. Trape spatula needle, measures 5.5mm in length, 7/16 curve, and 0.14mm in diameter.</p>	 <table border="1"> <thead> <tr> <th colspan="2">Suture</th> </tr> </thead> <tbody> <tr> <td>Description</td> <td>Nylon, Black Mono</td> </tr> <tr> <td>Length (cm)</td> <td>20</td> </tr> <tr> <td>Size</td> <td>11-0 (0.1 metric)</td> </tr> </tbody> </table> <table border="1"> <thead> <tr> <th colspan="2">Needle</th> </tr> </thead> <tbody> <tr> <td>Length (mm)</td> <td>5.5</td> </tr> <tr> <td>Curve</td> <td>7/16</td> </tr> <tr> <td>Diam. (mm)</td> <td>0.14</td> </tr> </tbody> </table>	Suture		Description	Nylon, Black Mono	Length (cm)	20	Size	11-0 (0.1 metric)	Needle		Length (mm)	5.5	Curve	7/16	Diam. (mm)	0.14
Suture																		
Description	Nylon, Black Mono																	
Length (cm)	20																	
Size	11-0 (0.1 metric)																	
Needle																		
Length (mm)	5.5																	
Curve	7/16																	
Diam. (mm)	0.14																	
AB-1000	<p><b>Nylon Suture, Trape Spatula</b></p> <p>Double-armed suture, measures 20cm in length. Trape spatula needle, measures 5.5mm in length, 7/16 curve, and 0.10mm in diameter.</p>	 <table border="1"> <thead> <tr> <th colspan="2">Suture</th> </tr> </thead> <tbody> <tr> <td>Description</td> <td>Nylon, Black Mono</td> </tr> <tr> <td>Length (cm)</td> <td>20</td> </tr> <tr> <td>Size</td> <td>11-0 (0.1 metric)</td> </tr> </tbody> </table> <table border="1"> <thead> <tr> <th colspan="2">Needle</th> </tr> </thead> <tbody> <tr> <td>Length (mm)</td> <td>5.5</td> </tr> <tr> <td>Curve</td> <td>7/16</td> </tr> <tr> <td>Diam. (mm)</td> <td>0.10</td> </tr> </tbody> </table>	Suture		Description	Nylon, Black Mono	Length (cm)	20	Size	11-0 (0.1 metric)	Needle		Length (mm)	5.5	Curve	7/16	Diam. (mm)	0.10
Suture																		
Description	Nylon, Black Mono																	
Length (cm)	20																	
Size	11-0 (0.1 metric)																	
Needle																		
Length (mm)	5.5																	
Curve	7/16																	
Diam. (mm)	0.10																	
AB-1000S	<p><b>Nylon Suture, Trape Spatula</b></p> <p>Single-armed suture, measures 10cm in length. Trape spatula needle, measures 5.5mm in length, 7/16 curve, and 0.10mm in diameter.</p>	 <table border="1"> <thead> <tr> <th colspan="2">Suture</th> </tr> </thead> <tbody> <tr> <td>Description</td> <td>Nylon, Black Mono</td> </tr> <tr> <td>Length (cm)</td> <td>10</td> </tr> <tr> <td>Size</td> <td>11-0 (0.1 metric)</td> </tr> </tbody> </table> <table border="1"> <thead> <tr> <th colspan="2">Needle</th> </tr> </thead> <tbody> <tr> <td>Length (mm)</td> <td>5.5</td> </tr> <tr> <td>Curve</td> <td>7/16</td> </tr> <tr> <td>Diam. (mm)</td> <td>0.10</td> </tr> </tbody> </table>	Suture		Description	Nylon, Black Mono	Length (cm)	10	Size	11-0 (0.1 metric)	Needle		Length (mm)	5.5	Curve	7/16	Diam. (mm)	0.10
Suture																		
Description	Nylon, Black Mono																	
Length (cm)	10																	
Size	11-0 (0.1 metric)																	
Needle																		
Length (mm)	5.5																	
Curve	7/16																	
Diam. (mm)	0.10																	
AB-1478S	<p><b>Nylon Suture, Trape Spatula</b></p> <p>Single-armed suture, measures 15cm in length. Trape spatula needle, measures 6.0mm in length, 3/8 curve, and 0.14mm in diameter.</p>	 <table border="1"> <thead> <tr> <th colspan="2">Suture</th> </tr> </thead> <tbody> <tr> <td>Description</td> <td>Nylon, Black Mono</td> </tr> <tr> <td>Length (cm)</td> <td>15</td> </tr> <tr> <td>Size</td> <td>11-0 (0.1 metric)</td> </tr> </tbody> </table> <table border="1"> <thead> <tr> <th colspan="2">Needle</th> </tr> </thead> <tbody> <tr> <td>Length (mm)</td> <td>6.0</td> </tr> <tr> <td>Curve</td> <td>3/8</td> </tr> <tr> <td>Diam. (mm)</td> <td>0.14</td> </tr> </tbody> </table>	Suture		Description	Nylon, Black Mono	Length (cm)	15	Size	11-0 (0.1 metric)	Needle		Length (mm)	6.0	Curve	3/8	Diam. (mm)	0.14
Suture																		
Description	Nylon, Black Mono																	
Length (cm)	15																	
Size	11-0 (0.1 metric)																	
Needle																		
Length (mm)	6.0																	
Curve	3/8																	
Diam. (mm)	0.14																	

NYLON

Item #	Description	Image
--------	-------------	-------

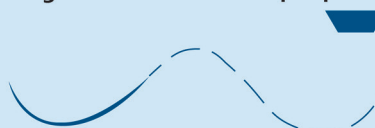
Sutures 10-0 Nylon

Mani brand 10-0, black mono, nylon sutures with both single and double arms. Taper point and trape spatula needles ranging in length, curve, and diameter. Mani sutures are ideal for micro-suturing on the cornea and sclera during eye surgery. Ultimate sharpness is obtained through the "cross-lapped edge" technique giving each suture a fine and sharp tip ensuring minimally invasive wound closure. Mani hard fiber stainless steel is used to make strong and break-resistant needles. Sold 12 per box.

<p>AB-1001</p> <p><b>Nylon Suture, Trape Spatula</b></p> <p>Double-armed suture, measures 30cm in length. Trape spatula needle, measures 5.5mm in length, 7/16 curve, and 0.10mm in diameter.</p>	<p><b>Double-Armed Trape Spatula</b></p> 	<table border="1"> <thead> <tr> <th colspan="2">Suture</th> </tr> </thead> <tbody> <tr> <td>Description</td> <td>Nylon, Black Mono</td> </tr> <tr> <td>Length (cm)</td> <td>30</td> </tr> <tr> <td>Size</td> <td>10-0 (0.2 metric)</td> </tr> </tbody> </table> <table border="1"> <thead> <tr> <th colspan="2">Needle</th> </tr> </thead> <tbody> <tr> <td>Length (mm)</td> <td>5.5</td> </tr> <tr> <td>Curve</td> <td>7/16</td> </tr> <tr> <td>Diam. (mm)</td> <td>0.10</td> </tr> </tbody> </table>	Suture		Description	Nylon, Black Mono	Length (cm)	30	Size	10-0 (0.2 metric)	Needle		Length (mm)	5.5	Curve	7/16	Diam. (mm)	0.10
Suture																		
Description	Nylon, Black Mono																	
Length (cm)	30																	
Size	10-0 (0.2 metric)																	
Needle																		
Length (mm)	5.5																	
Curve	7/16																	
Diam. (mm)	0.10																	
<p>AB-1052S</p> <p><b>Nylon Suture, Taper Point</b></p> <p>Single-armed suture, measures 20cm in length. Taper point needle, measures 5.0mm in length, 3/8 curve, and 0.10mm in diameter.</p>	<p><b>Single-Armed Taper Point</b></p> 	<table border="1"> <thead> <tr> <th colspan="2">Suture</th> </tr> </thead> <tbody> <tr> <td>Description</td> <td>Nylon, Black Mono</td> </tr> <tr> <td>Length (cm)</td> <td>20</td> </tr> <tr> <td>Size</td> <td>10-0 (0.2 metric)</td> </tr> </tbody> </table> <table border="1"> <thead> <tr> <th colspan="2">Needle</th> </tr> </thead> <tbody> <tr> <td>Length (mm)</td> <td>5.0</td> </tr> <tr> <td>Curve</td> <td>3/8</td> </tr> <tr> <td>Diam. (mm)</td> <td>0.10</td> </tr> </tbody> </table>	Suture		Description	Nylon, Black Mono	Length (cm)	20	Size	10-0 (0.2 metric)	Needle		Length (mm)	5.0	Curve	3/8	Diam. (mm)	0.10
Suture																		
Description	Nylon, Black Mono																	
Length (cm)	20																	
Size	10-0 (0.2 metric)																	
Needle																		
Length (mm)	5.0																	
Curve	3/8																	
Diam. (mm)	0.10																	
<p>AB-1401</p> <p><b>Nylon Suture, Trape Spatula</b></p> <p>Double-armed suture, measures 30cm in length. Trape spatula needle, measures 5.0mm in length, bi-curve, and 0.14mm in diameter.</p>	<p><b>Double-Armed Trape Spatula</b></p> 	<table border="1"> <thead> <tr> <th colspan="2">Suture</th> </tr> </thead> <tbody> <tr> <td>Description</td> <td>Nylon, Black Mono</td> </tr> <tr> <td>Length (cm)</td> <td>30</td> </tr> <tr> <td>Size</td> <td>10-0 (0.2 metric)</td> </tr> </tbody> </table> <table border="1"> <thead> <tr> <th colspan="2">Needle</th> </tr> </thead> <tbody> <tr> <td>Length (mm)</td> <td>5.0</td> </tr> <tr> <td>Curve</td> <td>Bi-curve</td> </tr> <tr> <td>Diam. (mm)</td> <td>0.14</td> </tr> </tbody> </table>	Suture		Description	Nylon, Black Mono	Length (cm)	30	Size	10-0 (0.2 metric)	Needle		Length (mm)	5.0	Curve	Bi-curve	Diam. (mm)	0.14
Suture																		
Description	Nylon, Black Mono																	
Length (cm)	30																	
Size	10-0 (0.2 metric)																	
Needle																		
Length (mm)	5.0																	
Curve	Bi-curve																	
Diam. (mm)	0.14																	
<p>AB-1401S</p> <p><b>Nylon Suture, Trape Spatula</b></p> <p>Single-armed suture, measures 15cm in length. Trape spatula needle, measures 5.0mm in length, bi-curve, and 0.14mm in diameter.</p>	<p><b>Single-Armed Trape Spatula</b></p> 	<table border="1"> <thead> <tr> <th colspan="2">Suture</th> </tr> </thead> <tbody> <tr> <td>Description</td> <td>Nylon, Black Mono</td> </tr> <tr> <td>Length (cm)</td> <td>15</td> </tr> <tr> <td>Size</td> <td>10-0 (0.2 metric)</td> </tr> </tbody> </table> <table border="1"> <thead> <tr> <th colspan="2">Needle</th> </tr> </thead> <tbody> <tr> <td>Length (mm)</td> <td>5.0</td> </tr> <tr> <td>Curve</td> <td>Bi-curve</td> </tr> <tr> <td>Diam. (mm)</td> <td>0.14</td> </tr> </tbody> </table>	Suture		Description	Nylon, Black Mono	Length (cm)	15	Size	10-0 (0.2 metric)	Needle		Length (mm)	5.0	Curve	Bi-curve	Diam. (mm)	0.14
Suture																		
Description	Nylon, Black Mono																	
Length (cm)	15																	
Size	10-0 (0.2 metric)																	
Needle																		
Length (mm)	5.0																	
Curve	Bi-curve																	
Diam. (mm)	0.14																	
<p>AB-1404</p> <p><b>Nylon Suture, Trape Spatula</b></p> <p>Double-armed suture, measures 30cm in length. Trape spatula needle, measures 5.5mm in length, 7/16 curve, and 0.14mm in diameter.</p>	<p><b>Double-Armed Trape Spatula</b></p> 	<table border="1"> <thead> <tr> <th colspan="2">Suture</th> </tr> </thead> <tbody> <tr> <td>Description</td> <td>Nylon, Black Mono</td> </tr> <tr> <td>Length (cm)</td> <td>30</td> </tr> <tr> <td>Size</td> <td>10-0 (0.2 metric)</td> </tr> </tbody> </table> <table border="1"> <thead> <tr> <th colspan="2">Needle</th> </tr> </thead> <tbody> <tr> <td>Length (mm)</td> <td>5.5</td> </tr> <tr> <td>Curve</td> <td>7/16</td> </tr> <tr> <td>Diam. (mm)</td> <td>0.14</td> </tr> </tbody> </table>	Suture		Description	Nylon, Black Mono	Length (cm)	30	Size	10-0 (0.2 metric)	Needle		Length (mm)	5.5	Curve	7/16	Diam. (mm)	0.14
Suture																		
Description	Nylon, Black Mono																	
Length (cm)	30																	
Size	10-0 (0.2 metric)																	
Needle																		
Length (mm)	5.5																	
Curve	7/16																	
Diam. (mm)	0.14																	
<p>AB-1404S</p> <p><b>Nylon Suture, Trape Spatula</b></p> <p>Single-armed suture, measures 15cm in length. Trape spatula needle, measures 5.5mm in length, 7/16 curve, and 0.14mm in diameter.</p>	<p><b>Single-Armed Trape Spatula</b></p> 	<table border="1"> <thead> <tr> <th colspan="2">Suture</th> </tr> </thead> <tbody> <tr> <td>Description</td> <td>Nylon, Black Mono</td> </tr> <tr> <td>Length (cm)</td> <td>15</td> </tr> <tr> <td>Size</td> <td>10-0 (0.2 metric)</td> </tr> </tbody> </table> <table border="1"> <thead> <tr> <th colspan="2">Needle</th> </tr> </thead> <tbody> <tr> <td>Length (mm)</td> <td>5.5</td> </tr> <tr> <td>Curve</td> <td>7/16</td> </tr> <tr> <td>Diam. (mm)</td> <td>0.14</td> </tr> </tbody> </table>	Suture		Description	Nylon, Black Mono	Length (cm)	15	Size	10-0 (0.2 metric)	Needle		Length (mm)	5.5	Curve	7/16	Diam. (mm)	0.14
Suture																		
Description	Nylon, Black Mono																	
Length (cm)	15																	
Size	10-0 (0.2 metric)																	
Needle																		
Length (mm)	5.5																	
Curve	7/16																	
Diam. (mm)	0.14																	
<p>AB-1406</p> <p><b>Nylon Suture, Trape Spatula</b></p> <p>Double-armed suture, measures 30cm in length. Trape spatula needle, measures 6.0mm in length, 3/8 curve, and 0.14mm in diameter.</p>	<p><b>Double-Armed Trape Spatula</b></p> 	<table border="1"> <thead> <tr> <th colspan="2">Suture</th> </tr> </thead> <tbody> <tr> <td>Description</td> <td>Nylon, Black Mono</td> </tr> <tr> <td>Length (cm)</td> <td>30</td> </tr> <tr> <td>Size</td> <td>10-0 (0.2 metric)</td> </tr> </tbody> </table> <table border="1"> <thead> <tr> <th colspan="2">Needle</th> </tr> </thead> <tbody> <tr> <td>Length (mm)</td> <td>6.0</td> </tr> <tr> <td>Curve</td> <td>3/8</td> </tr> <tr> <td>Diam. (mm)</td> <td>0.14</td> </tr> </tbody> </table>	Suture		Description	Nylon, Black Mono	Length (cm)	30	Size	10-0 (0.2 metric)	Needle		Length (mm)	6.0	Curve	3/8	Diam. (mm)	0.14
Suture																		
Description	Nylon, Black Mono																	
Length (cm)	30																	
Size	10-0 (0.2 metric)																	
Needle																		
Length (mm)	6.0																	
Curve	3/8																	
Diam. (mm)	0.14																	

NYLON

Item #	Description	Image																
AB-I406S	<p><b>Nylon Suture, Trape Spatula</b></p> <p>Single-armed suture, measures 15cm in length. Trape spatula needle, measures 6.0mm in length, 3/8 curve, and 0.14mm in diameter.</p>	<table border="1"> <thead> <tr> <th colspan="2">Suture</th> </tr> </thead> <tbody> <tr> <td>Description</td> <td>Nylon, Black Mono</td> </tr> <tr> <td>Length (cm)</td> <td>15</td> </tr> <tr> <td>Size</td> <td>10-0 (0.2 metric)</td> </tr> </tbody> </table> <table border="1"> <thead> <tr> <th colspan="2">Needle</th> </tr> </thead> <tbody> <tr> <td>Length (mm)</td> <td>6.0</td> </tr> <tr> <td>Curve</td> <td>3/8</td> </tr> <tr> <td>Diam. (mm)</td> <td>0.14</td> </tr> </tbody> </table>	Suture		Description	Nylon, Black Mono	Length (cm)	15	Size	10-0 (0.2 metric)	Needle		Length (mm)	6.0	Curve	3/8	Diam. (mm)	0.14
Suture																		
Description	Nylon, Black Mono																	
Length (cm)	15																	
Size	10-0 (0.2 metric)																	
Needle																		
Length (mm)	6.0																	
Curve	3/8																	
Diam. (mm)	0.14																	
AB-I410	<p><b>Nylon Suture, Trape Spatula</b></p> <p>Double-armed suture, measures 30cm in length. Trape spatula needle, measures 7.0mm in length, 1/2 curve, and 0.14mm in diameter.</p>	<table border="1"> <thead> <tr> <th colspan="2">Suture</th> </tr> </thead> <tbody> <tr> <td>Description</td> <td>Nylon, Black Mono</td> </tr> <tr> <td>Length (cm)</td> <td>30</td> </tr> <tr> <td>Size</td> <td>10-0 (0.2 metric)</td> </tr> </tbody> </table> <table border="1"> <thead> <tr> <th colspan="2">Needle</th> </tr> </thead> <tbody> <tr> <td>Length (mm)</td> <td>7.0</td> </tr> <tr> <td>Curve</td> <td>1/2</td> </tr> <tr> <td>Diam. (mm)</td> <td>0.14</td> </tr> </tbody> </table>	Suture		Description	Nylon, Black Mono	Length (cm)	30	Size	10-0 (0.2 metric)	Needle		Length (mm)	7.0	Curve	1/2	Diam. (mm)	0.14
Suture																		
Description	Nylon, Black Mono																	
Length (cm)	30																	
Size	10-0 (0.2 metric)																	
Needle																		
Length (mm)	7.0																	
Curve	1/2																	
Diam. (mm)	0.14																	
AB-I410S	<p><b>Nylon Suture, Trape Spatula</b></p> <p>Single armed suture, measures 15cm in length. Trape spatula needle, measures 7.0mm in length, 1/2 curve, and 0.14mm in diameter.</p>	<table border="1"> <thead> <tr> <th colspan="2">Suture</th> </tr> </thead> <tbody> <tr> <td>Description</td> <td>Nylon, Black Mono</td> </tr> <tr> <td>Length (cm)</td> <td>15</td> </tr> <tr> <td>Size</td> <td>10-0 (0.2 metric)</td> </tr> </tbody> </table> <table border="1"> <thead> <tr> <th colspan="2">Needle</th> </tr> </thead> <tbody> <tr> <td>Length (mm)</td> <td>7.0</td> </tr> <tr> <td>Curve</td> <td>1/2</td> </tr> <tr> <td>Diam. (mm)</td> <td>0.14</td> </tr> </tbody> </table>	Suture		Description	Nylon, Black Mono	Length (cm)	15	Size	10-0 (0.2 metric)	Needle		Length (mm)	7.0	Curve	1/2	Diam. (mm)	0.14
Suture																		
Description	Nylon, Black Mono																	
Length (cm)	15																	
Size	10-0 (0.2 metric)																	
Needle																		
Length (mm)	7.0																	
Curve	1/2																	
Diam. (mm)	0.14																	
AB-I452	<p><b>Nylon Suture, Trape Spatula</b></p> <p>Double-armed suture, measures 15cm in length. Trape spatula needle, measures 6.0mm in length, 3/8 curve, and 0.14mm in diameter.</p>	<table border="1"> <thead> <tr> <th colspan="2">Suture</th> </tr> </thead> <tbody> <tr> <td>Description</td> <td>Nylon, Black Mono</td> </tr> <tr> <td>Length (cm)</td> <td>15</td> </tr> <tr> <td>Size</td> <td>10-0 (0.2 metric)</td> </tr> </tbody> </table> <table border="1"> <thead> <tr> <th colspan="2">Needle</th> </tr> </thead> <tbody> <tr> <td>Length (mm)</td> <td>6.0</td> </tr> <tr> <td>Curve</td> <td>3/8</td> </tr> <tr> <td>Diam. (mm)</td> <td>0.14</td> </tr> </tbody> </table>	Suture		Description	Nylon, Black Mono	Length (cm)	15	Size	10-0 (0.2 metric)	Needle		Length (mm)	6.0	Curve	3/8	Diam. (mm)	0.14
Suture																		
Description	Nylon, Black Mono																	
Length (cm)	15																	
Size	10-0 (0.2 metric)																	
Needle																		
Length (mm)	6.0																	
Curve	3/8																	
Diam. (mm)	0.14																	
AB-I459	<p><b>Nylon Suture, Taper Point</b></p> <p>Double-armed suture, measures 45cm in length. Taper point needle, measures 6.0mm in length, 3/8 curve, and 0.14mm in diameter.</p>	<table border="1"> <thead> <tr> <th colspan="2">Suture</th> </tr> </thead> <tbody> <tr> <td>Description</td> <td>Nylon, Black Mono</td> </tr> <tr> <td>Length (cm)</td> <td>45</td> </tr> <tr> <td>Size</td> <td>10-0 (0.2 metric)</td> </tr> </tbody> </table> <table border="1"> <thead> <tr> <th colspan="2">Needle</th> </tr> </thead> <tbody> <tr> <td>Length (mm)</td> <td>6.0</td> </tr> <tr> <td>Curve</td> <td>3/8</td> </tr> <tr> <td>Diam. (mm)</td> <td>0.14</td> </tr> </tbody> </table>	Suture		Description	Nylon, Black Mono	Length (cm)	45	Size	10-0 (0.2 metric)	Needle		Length (mm)	6.0	Curve	3/8	Diam. (mm)	0.14
Suture																		
Description	Nylon, Black Mono																	
Length (cm)	45																	
Size	10-0 (0.2 metric)																	
Needle																		
Length (mm)	6.0																	
Curve	3/8																	
Diam. (mm)	0.14																	
AB-I468S	<p><b>Nylon Suture, Trape Spatula</b></p> <p>Single-armed suture, measures 6cm in length. Trape spatula needle, measures 6.0mm in length, 3/8 curve, and 0.14mm in diameter.</p>	<table border="1"> <thead> <tr> <th colspan="2">Suture</th> </tr> </thead> <tbody> <tr> <td>Description</td> <td>Nylon, Black Mono</td> </tr> <tr> <td>Length (cm)</td> <td>6</td> </tr> <tr> <td>Size</td> <td>10-0 (0.2 metric)</td> </tr> </tbody> </table> <table border="1"> <thead> <tr> <th colspan="2">Needle</th> </tr> </thead> <tbody> <tr> <td>Length (mm)</td> <td>6.0</td> </tr> <tr> <td>Curve</td> <td>3/8</td> </tr> <tr> <td>Diam. (mm)</td> <td>0.14</td> </tr> </tbody> </table>	Suture		Description	Nylon, Black Mono	Length (cm)	6	Size	10-0 (0.2 metric)	Needle		Length (mm)	6.0	Curve	3/8	Diam. (mm)	0.14
Suture																		
Description	Nylon, Black Mono																	
Length (cm)	6																	
Size	10-0 (0.2 metric)																	
Needle																		
Length (mm)	6.0																	
Curve	3/8																	
Diam. (mm)	0.14																	
AB-I474	<p><b>Nylon Suture, Trape Spatula</b></p> <p>Double-armed suture, measures 20cm in length. Trape spatula needle, measures 5.0mm in length, bi-curve, and 0.14mm in diameter.</p>	<table border="1"> <thead> <tr> <th colspan="2">Suture</th> </tr> </thead> <tbody> <tr> <td>Description</td> <td>Nylon, Black Mono</td> </tr> <tr> <td>Length (cm)</td> <td>20</td> </tr> <tr> <td>Size</td> <td>10-0 (0.2 metric)</td> </tr> </tbody> </table> <table border="1"> <thead> <tr> <th colspan="2">Needle</th> </tr> </thead> <tbody> <tr> <td>Length (mm)</td> <td>5.0</td> </tr> <tr> <td>Curve</td> <td>Bi-curve</td> </tr> <tr> <td>Diam. (mm)</td> <td>0.14</td> </tr> </tbody> </table>	Suture		Description	Nylon, Black Mono	Length (cm)	20	Size	10-0 (0.2 metric)	Needle		Length (mm)	5.0	Curve	Bi-curve	Diam. (mm)	0.14
Suture																		
Description	Nylon, Black Mono																	
Length (cm)	20																	
Size	10-0 (0.2 metric)																	
Needle																		
Length (mm)	5.0																	
Curve	Bi-curve																	
Diam. (mm)	0.14																	
AB-I482	<p><b>Nylon Suture, Trape Spatula</b></p> <p>Double-armed suture, measures 15cm in length. Trape spatula needle, measures 5.5mm in length, 7/16 curve, and 0.14mm in diameter.</p>	<table border="1"> <thead> <tr> <th colspan="2">Suture</th> </tr> </thead> <tbody> <tr> <td>Description</td> <td>Nylon, Black Mono</td> </tr> <tr> <td>Length (cm)</td> <td>15</td> </tr> <tr> <td>Size</td> <td>10-0 (0.2 metric)</td> </tr> </tbody> </table> <table border="1"> <thead> <tr> <th colspan="2">Needle</th> </tr> </thead> <tbody> <tr> <td>Length (mm)</td> <td>5.5</td> </tr> <tr> <td>Curve</td> <td>7/16</td> </tr> <tr> <td>Diam. (mm)</td> <td>0.14</td> </tr> </tbody> </table>	Suture		Description	Nylon, Black Mono	Length (cm)	15	Size	10-0 (0.2 metric)	Needle		Length (mm)	5.5	Curve	7/16	Diam. (mm)	0.14
Suture																		
Description	Nylon, Black Mono																	
Length (cm)	15																	
Size	10-0 (0.2 metric)																	
Needle																		
Length (mm)	5.5																	
Curve	7/16																	
Diam. (mm)	0.14																	



NYLON

Item #	Description	Image	Suture	Needle
AB-2000	<b>Nylon Suture, Trape Spatula</b> Double-armed suture, measures 30cm in length. Trape spatula needle, measures 5.5mm in length, 7/16 curve, and 0.20mm in diameter.	<b>Double-Armed Trape Spatula</b> 	<b>Description</b> Nylon, Black Mono <b>Length (cm)</b> 30 <b>Size</b> 10-0 (0.2 metric)	<b>Length (mm)</b> 5.5 <b>Curve</b> 7/16 <b>Diam. (mm)</b> 0.20
AB-2002	<b>Nylon Suture, Trape Spatula</b> Double-armed suture, measures 30cm in length. Trape spatula needle, measures 6.5mm in length, 3/8 curve, and 0.20mm in diameter.	<b>Double-Armed Trape Spatula</b> 	<b>Description</b> Nylon, Black Mono <b>Length (cm)</b> 30 <b>Size</b> 10-0 (0.2 metric)	<b>Length (mm)</b> 6.5 <b>Curve</b> 3/8 <b>Diam. (mm)</b> 0.20
AB-1053S	<b>Nylon Suture, Taper Point</b> Single-armed suture, measures 20cm in length. Taper point needle, measures 4.0mm in length, 3/8 curve, and 0.10mm in diameter.	<b>Single-Armed Taper Point</b> 	<b>Description</b> Nylon, Black Mono <b>Length (cm)</b> 20 <b>Size</b> 10-0 (0.2 metric)	<b>Length (mm)</b> 4.0 <b>Curve</b> 3/8 <b>Diam. (mm)</b> 0.10
AB-1475	<b>Nylon Suture, Taper Point</b> Double-armed suture, measures 30cm in length. Taper point needle, measures 5.5mm in length, 7/16 curve, and 0.14mm in diameter.	<b>Double-Armed Taper Point</b> 	<b>Description</b> Nylon, Black Mono <b>Length (cm)</b> 30 <b>Size</b> 10-0 (0.2 metric)	<b>Length (mm)</b> 5.5 <b>Curve</b> 7/16 <b>Diam. (mm)</b> 0.14
AB-2002S	<b>Nylon Suture, Trape Spatula</b> Single-armed suture, measures 15cm in length. Trape spatula needle, measures 6.5mm in length, 3/8 curve, and 0.20mm in diameter.	<b>Single-Armed Trape Spatula</b> 	<b>Description</b> Nylon, Black Mono <b>Length (cm)</b> 15 <b>Size</b> 10-0 (0.2 metric)	<b>Length (mm)</b> 6.5 <b>Curve</b> 3/8 <b>Diam. (mm)</b> 0.20

Sutures 9-0 Nylon

Mani brand 9-0, black mono, nylon sutures with both single and double arms. Trape spatula needles ranging in length, curve, and diameter. Mani sutures are ideal for micro-suturing on the cornea and sclera during eye surgery. Ultimate sharpness is obtained through the "cross-lapped edge" technique giving each suture a fine and sharp tip ensuring minimally invasive wound closure. Mani hard fiber stainless steel is used to make strong and break-resistant needles. Sold 12 per box.

AB-1405	<b>Nylon Suture, Trape Spatula</b> Double-armed suture, measures 30cm in length. Trape spatula needle, measures 5.5mm in length, 7/16 curve, and 0.14mm in diameter.	<b>Double-Armed Trape Spatula</b> 	<b>Description</b> Nylon, Black Mono <b>Length (cm)</b> 30 <b>Size</b> 9-0 (0.3 metric)	<b>Length (mm)</b> 5.5 <b>Curve</b> 7/16 <b>Diam. (mm)</b> 0.14
AB-1407	<b>Nylon Suture, Trape Spatula</b> Double-armed suture, measures 30cm in length. Trape spatula needle, measures 6.0mm in length, 3/8 curve, and 0.14mm in diameter.	<b>Double-Armed Trape Spatula</b> 	<b>Description</b> Nylon, Black Mono <b>Length (cm)</b> 30 <b>Size</b> 9-0 (0.3 metric)	<b>Length (mm)</b> 6.0 <b>Curve</b> 3/8 <b>Diam. (mm)</b> 0.14

NYLON

Item #	Description	Image																
AB-2003	<p><b>Nylon Suture, Trape Spatula</b></p> <p>Double-armed suture, measures 30cm in length. Trape spatula needle, measures 6.5mm in length, 3/8 curve, and 0.20mm in diameter.</p>	<table border="1"> <thead> <tr> <th colspan="2">Suture</th> </tr> </thead> <tbody> <tr> <td>Description</td> <td>Nylon, Black Mono</td> </tr> <tr> <td>Length (cm)</td> <td>30</td> </tr> <tr> <td>Size</td> <td>9-0 (0.3 metric)</td> </tr> </tbody> </table> <table border="1"> <thead> <tr> <th colspan="2">Needle</th> </tr> </thead> <tbody> <tr> <td>Length (mm)</td> <td>6.5</td> </tr> <tr> <td>Curve</td> <td>3/8</td> </tr> <tr> <td>Diam. (mm)</td> <td>0.20</td> </tr> </tbody> </table>	Suture		Description	Nylon, Black Mono	Length (cm)	30	Size	9-0 (0.3 metric)	Needle		Length (mm)	6.5	Curve	3/8	Diam. (mm)	0.20
Suture																		
Description	Nylon, Black Mono																	
Length (cm)	30																	
Size	9-0 (0.3 metric)																	
Needle																		
Length (mm)	6.5																	
Curve	3/8																	
Diam. (mm)	0.20																	
AB-1402	<p><b>Nylon Suture, Trape Spatula</b></p> <p>Double-armed suture, measures 30cm in length. Trape spatula needle, measures 5.0mm in length, bi-curve, and 0.14mm in diameter.</p>	<table border="1"> <thead> <tr> <th colspan="2">Suture</th> </tr> </thead> <tbody> <tr> <td>Description</td> <td>Nylon, Black Mono</td> </tr> <tr> <td>Length (cm)</td> <td>30</td> </tr> <tr> <td>Size</td> <td>9-0 (0.3 metric)</td> </tr> </tbody> </table> <table border="1"> <thead> <tr> <th colspan="2">Needle</th> </tr> </thead> <tbody> <tr> <td>Length (mm)</td> <td>5.0</td> </tr> <tr> <td>Curve</td> <td>Bi-curve</td> </tr> <tr> <td>Diam. (mm)</td> <td>0.14</td> </tr> </tbody> </table>	Suture		Description	Nylon, Black Mono	Length (cm)	30	Size	9-0 (0.3 metric)	Needle		Length (mm)	5.0	Curve	Bi-curve	Diam. (mm)	0.14
Suture																		
Description	Nylon, Black Mono																	
Length (cm)	30																	
Size	9-0 (0.3 metric)																	
Needle																		
Length (mm)	5.0																	
Curve	Bi-curve																	
Diam. (mm)	0.14																	
AB-1407S	<p><b>Nylon Suture, Trape Spatula</b></p> <p>Single-armed suture, measures 15cm in length. Trape spatula needle, measures 6.0mm in length, 3/8 curve, and 0.14mm in diameter.</p>	<table border="1"> <thead> <tr> <th colspan="2">Suture</th> </tr> </thead> <tbody> <tr> <td>Description</td> <td>Nylon, Black Mono</td> </tr> <tr> <td>Length (cm)</td> <td>15</td> </tr> <tr> <td>Size</td> <td>9-0 (0.3 metric)</td> </tr> </tbody> </table> <table border="1"> <thead> <tr> <th colspan="2">Needle</th> </tr> </thead> <tbody> <tr> <td>Length (mm)</td> <td>6.0</td> </tr> <tr> <td>Curve</td> <td>3/8</td> </tr> <tr> <td>Diam. (mm)</td> <td>0.14</td> </tr> </tbody> </table>	Suture		Description	Nylon, Black Mono	Length (cm)	15	Size	9-0 (0.3 metric)	Needle		Length (mm)	6.0	Curve	3/8	Diam. (mm)	0.14
Suture																		
Description	Nylon, Black Mono																	
Length (cm)	15																	
Size	9-0 (0.3 metric)																	
Needle																		
Length (mm)	6.0																	
Curve	3/8																	
Diam. (mm)	0.14																	
AB-2003S	<p><b>Nylon Suture, Trape Spatula</b></p> <p>Single-armed suture, measures 15cm in length. Trape spatula needle, measures 6.5mm in length, 3/8 curve, and 0.20mm in diameter.</p>	<table border="1"> <thead> <tr> <th colspan="2">Suture</th> </tr> </thead> <tbody> <tr> <td>Description</td> <td>Nylon, Black Mono</td> </tr> <tr> <td>Length (cm)</td> <td>15</td> </tr> <tr> <td>Size</td> <td>9-0 (0.3 metric)</td> </tr> </tbody> </table> <table border="1"> <thead> <tr> <th colspan="2">Needle</th> </tr> </thead> <tbody> <tr> <td>Length (mm)</td> <td>6.5</td> </tr> <tr> <td>Curve</td> <td>3/8</td> </tr> <tr> <td>Diam. (mm)</td> <td>0.20</td> </tr> </tbody> </table>	Suture		Description	Nylon, Black Mono	Length (cm)	15	Size	9-0 (0.3 metric)	Needle		Length (mm)	6.5	Curve	3/8	Diam. (mm)	0.20
Suture																		
Description	Nylon, Black Mono																	
Length (cm)	15																	
Size	9-0 (0.3 metric)																	
Needle																		
Length (mm)	6.5																	
Curve	3/8																	
Diam. (mm)	0.20																	

Sutures 8-0 Nylon

Mani brand 8-0, black mono, nylon sutures with both single and double arms. Trape spatula and reverse cut needles ranging in length, curve, and diameter. Mani sutures are ideal for micro-suturing on the cornea and sclera during eye surgery. Ultimate sharpness is obtained through the "cross-lapped edge" technique giving each suture a fine and sharp tip ensuring minimally invasive wound closure. Mani hard fiber stainless steel is used to make strong and break-resistant needles. Sold 12 per box.

AB-1421	<p><b>Nylon Suture, Trape Spatula</b></p> <p>Double-armed suture, measures 30cm in length. Trape Spatula needle, measures 5.5mm in length, 7/16 curve, and 0.14mm in diameter.</p>	<table border="1"> <thead> <tr> <th colspan="2">Suture</th> </tr> </thead> <tbody> <tr> <td>Description</td> <td>Nylon, Black Mono</td> </tr> <tr> <td>Length (cm)</td> <td>30</td> </tr> <tr> <td>Size</td> <td>8-0 (0.4 metric)</td> </tr> </tbody> </table> <table border="1"> <thead> <tr> <th colspan="2">Needle</th> </tr> </thead> <tbody> <tr> <td>Length (mm)</td> <td>5.5</td> </tr> <tr> <td>Curve</td> <td>7/16</td> </tr> <tr> <td>Diam. (mm)</td> <td>0.14</td> </tr> </tbody> </table>	Suture		Description	Nylon, Black Mono	Length (cm)	30	Size	8-0 (0.4 metric)	Needle		Length (mm)	5.5	Curve	7/16	Diam. (mm)	0.14
Suture																		
Description	Nylon, Black Mono																	
Length (cm)	30																	
Size	8-0 (0.4 metric)																	
Needle																		
Length (mm)	5.5																	
Curve	7/16																	
Diam. (mm)	0.14																	
AB-2028	<p><b>Nylon Suture, Trape Spatula</b></p> <p>Double-armed suture, measures 30cm in length. Trape spatula needle, measures 7.0mm in length, 1/2 curve, and 0.20mm in diameter.</p>	<table border="1"> <thead> <tr> <th colspan="2">Suture</th> </tr> </thead> <tbody> <tr> <td>Description</td> <td>Nylon, Black Mono</td> </tr> <tr> <td>Length (cm)</td> <td>30</td> </tr> <tr> <td>Size</td> <td>8-0 (0.4 metric)</td> </tr> </tbody> </table> <table border="1"> <thead> <tr> <th colspan="2">Needle</th> </tr> </thead> <tbody> <tr> <td>Length (mm)</td> <td>7.0</td> </tr> <tr> <td>Curve</td> <td>1/2</td> </tr> <tr> <td>Diam. (mm)</td> <td>0.20</td> </tr> </tbody> </table>	Suture		Description	Nylon, Black Mono	Length (cm)	30	Size	8-0 (0.4 metric)	Needle		Length (mm)	7.0	Curve	1/2	Diam. (mm)	0.20
Suture																		
Description	Nylon, Black Mono																	
Length (cm)	30																	
Size	8-0 (0.4 metric)																	
Needle																		
Length (mm)	7.0																	
Curve	1/2																	
Diam. (mm)	0.20																	
AB-2054	<p><b>Nylon Suture, Trape Spatula</b></p> <p>Double-armed suture, measures 30cm in length. Trape spatula needle, measures 6.5mm in length, 1/4 curve, and 0.20mm in diameter.</p>	<table border="1"> <thead> <tr> <th colspan="2">Suture</th> </tr> </thead> <tbody> <tr> <td>Description</td> <td>Nylon, Black Mono</td> </tr> <tr> <td>Length (cm)</td> <td>30</td> </tr> <tr> <td>Size</td> <td>8-0 (0.4 metric)</td> </tr> </tbody> </table> <table border="1"> <thead> <tr> <th colspan="2">Needle</th> </tr> </thead> <tbody> <tr> <td>Length (mm)</td> <td>6.5</td> </tr> <tr> <td>Curve</td> <td>1/4</td> </tr> <tr> <td>Diam. (mm)</td> <td>0.20</td> </tr> </tbody> </table>	Suture		Description	Nylon, Black Mono	Length (cm)	30	Size	8-0 (0.4 metric)	Needle		Length (mm)	6.5	Curve	1/4	Diam. (mm)	0.20
Suture																		
Description	Nylon, Black Mono																	
Length (cm)	30																	
Size	8-0 (0.4 metric)																	
Needle																		
Length (mm)	6.5																	
Curve	1/4																	
Diam. (mm)	0.20																	

NYLON

Item #	Description	Image	Suture	Needle												
AB-2056	<b>Nylon Suture, Trape Spatula</b> Double-armed suture, measures 30cm in length. Trape spatula needle, measures 6.5mm in length, 3/8 curve, and 0.20mm in diameter.	<b>Double-Armed Trape Spatula</b> 	<table border="1"><tr><td>Description</td><td>Nylon, Black Mono</td></tr><tr><td>Length (cm)</td><td>30</td></tr><tr><td>Size</td><td>8-0 (0.4 metric)</td></tr></table>	Description	Nylon, Black Mono	Length (cm)	30	Size	8-0 (0.4 metric)	<table border="1"><tr><td>Length (mm)</td><td>6.5</td></tr><tr><td>Curve</td><td>3/8</td></tr><tr><td>Diam. (mm)</td><td>0.20</td></tr></table>	Length (mm)	6.5	Curve	3/8	Diam. (mm)	0.20
Description	Nylon, Black Mono															
Length (cm)	30															
Size	8-0 (0.4 metric)															
Length (mm)	6.5															
Curve	3/8															
Diam. (mm)	0.20															
AB-2461S	<b>Nylon Suture, Reverse Cut</b> Single-armed suture, measures 50cm in length. Reverse cut needle, measures 11.0mm in length, 3/8 curve, and 0.24mm in diameter.	<b>Single-Armed Reverse Cut</b> 	<table border="1"><tr><td>Description</td><td>Nylon, Black Mono</td></tr><tr><td>Length (cm)</td><td>50</td></tr><tr><td>Size</td><td>8-0 (0.4 metric)</td></tr></table>	Description	Nylon, Black Mono	Length (cm)	50	Size	8-0 (0.4 metric)	<table border="1"><tr><td>Length (mm)</td><td>11.0</td></tr><tr><td>Curve</td><td>3/8</td></tr><tr><td>Diam. (mm)</td><td>0.24</td></tr></table>	Length (mm)	11.0	Curve	3/8	Diam. (mm)	0.24
Description	Nylon, Black Mono															
Length (cm)	50															
Size	8-0 (0.4 metric)															
Length (mm)	11.0															
Curve	3/8															
Diam. (mm)	0.24															
AB-2461	<b>Nylon Suture, Reverse Cut</b> Double-armed suture, measures 50cm in length. Reverse cut needle, measures 11.0mm in length, 3/8 curve, and 0.24mm in diameter.	<b>Double-Armed Reverse Cut</b> 	<table border="1"><tr><td>Description</td><td>Nylon, Black Mono</td></tr><tr><td>Length (cm)</td><td>50</td></tr><tr><td>Size</td><td>8-0 (0.4 metric)</td></tr></table>	Description	Nylon, Black Mono	Length (cm)	50	Size	8-0 (0.4 metric)	<table border="1"><tr><td>Length (mm)</td><td>11.0</td></tr><tr><td>Curve</td><td>3/8</td></tr><tr><td>Diam. (mm)</td><td>0.24</td></tr></table>	Length (mm)	11.0	Curve	3/8	Diam. (mm)	0.24
Description	Nylon, Black Mono															
Length (cm)	50															
Size	8-0 (0.4 metric)															
Length (mm)	11.0															
Curve	3/8															
Diam. (mm)	0.24															

Sutures 7-0 Nylon

Mani brand 7-0, black mono, nylon sutures with both single and double arms. Trape spatula, lancet, cut taper, and reverse cut needles ranging in length, curve, and diameter. Mani sutures are ideal for micro-suturing on the cornea and sclera during eye surgery. Ultimate sharpness is obtained through the "cross-lapped edge" technique giving each suture a fine and sharp tip ensuring minimally invasive wound closure. Mani hard fiber stainless steel is used to make strong and break-resistant needles. Sold 12 per box.

AB-2058	<b>Nylon Suture, Trape Spatula</b> Double-armed suture, measures 30cm in length. Trape spatula needle, measures 6.5mm in length, 3/8 curve, and 0.20mm in diameter.	<b>Double-Armed Trape Spatula</b> 	<table border="1"><tr><td>Description</td><td>Nylon, Black Mono</td></tr><tr><td>Length (cm)</td><td>30</td></tr><tr><td>Size</td><td>7-0 (0.5 metric)</td></tr></table>	Description	Nylon, Black Mono	Length (cm)	30	Size	7-0 (0.5 metric)	<table border="1"><tr><td>Length (mm)</td><td>6.5</td></tr><tr><td>Curve</td><td>3/8</td></tr><tr><td>Diam. (mm)</td><td>0.20</td></tr></table>	Length (mm)	6.5	Curve	3/8	Diam. (mm)	0.20
Description	Nylon, Black Mono															
Length (cm)	30															
Size	7-0 (0.5 metric)															
Length (mm)	6.5															
Curve	3/8															
Diam. (mm)	0.20															
AB-3365	<b>Nylon Suture, Cut Taper</b> Double-armed suture, measures 30cm in length. Cut taper needle, measures 15.0mm in length, 3/8 curve, and 0.33mm in diameter.	<b>Double-Armed Cut Taper</b> 	<table border="1"><tr><td>Description</td><td>Nylon, Black Mono</td></tr><tr><td>Length (cm)</td><td>30</td></tr><tr><td>Size</td><td>7-0 (0.5 metric)</td></tr></table>	Description	Nylon, Black Mono	Length (cm)	30	Size	7-0 (0.5 metric)	<table border="1"><tr><td>Length (mm)</td><td>15.0</td></tr><tr><td>Curve</td><td>3/8</td></tr><tr><td>Diam. (mm)</td><td>0.33</td></tr></table>	Length (mm)	15.0	Curve	3/8	Diam. (mm)	0.33
Description	Nylon, Black Mono															
Length (cm)	30															
Size	7-0 (0.5 metric)															
Length (mm)	15.0															
Curve	3/8															
Diam. (mm)	0.33															
AB-2455S	<b>Nylon Suture, Reverse Cut</b> Single-armed suture, measures 45cm in length. Reverse cut needle, measures 7.0mm in length, 3/8 curve, and 0.24mm in diameter.	<b>Single-Armed Reverse Cut</b> 	<table border="1"><tr><td>Description</td><td>Nylon, Black Mono</td></tr><tr><td>Length (cm)</td><td>45</td></tr><tr><td>Size</td><td>7-0 (0.5 metric)</td></tr></table>	Description	Nylon, Black Mono	Length (cm)	45	Size	7-0 (0.5 metric)	<table border="1"><tr><td>Length (mm)</td><td>7.0</td></tr><tr><td>Curve</td><td>3/8</td></tr><tr><td>Diam. (mm)</td><td>0.24</td></tr></table>	Length (mm)	7.0	Curve	3/8	Diam. (mm)	0.24
Description	Nylon, Black Mono															
Length (cm)	45															
Size	7-0 (0.5 metric)															
Length (mm)	7.0															
Curve	3/8															
Diam. (mm)	0.24															
AB-2457S	<b>Nylon Suture, Reverse Cut</b> Single-armed suture, measures 50cm in length. Reverse cut needle, measures 9.0mm in length, 3/8 curve, and 0.24mm in diameter.	<b>Single-Armed Reverse Cut</b> 	<table border="1"><tr><td>Description</td><td>Nylon, Black Mono</td></tr><tr><td>Length (cm)</td><td>50</td></tr><tr><td>Size</td><td>7-0 (0.5 metric)</td></tr></table>	Description	Nylon, Black Mono	Length (cm)	50	Size	7-0 (0.5 metric)	<table border="1"><tr><td>Length (mm)</td><td>9.0</td></tr><tr><td>Curve</td><td>3/8</td></tr><tr><td>Diam. (mm)</td><td>0.24</td></tr></table>	Length (mm)	9.0	Curve	3/8	Diam. (mm)	0.24
Description	Nylon, Black Mono															
Length (cm)	50															
Size	7-0 (0.5 metric)															
Length (mm)	9.0															
Curve	3/8															
Diam. (mm)	0.24															

NYLON

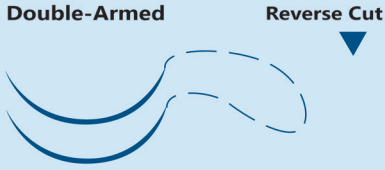
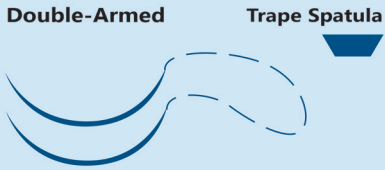
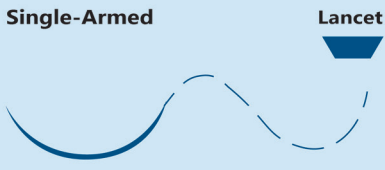
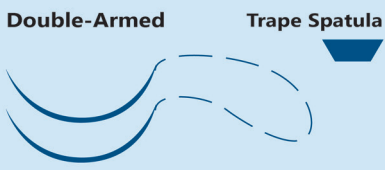
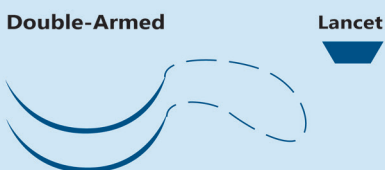
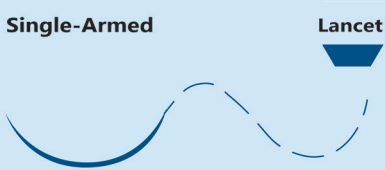
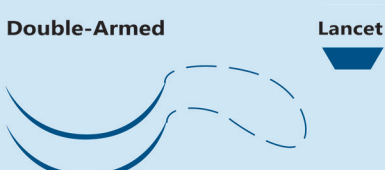





Item #	Description	Image																
AB-2463	<p><b>Nylon Suture, Reverse Cut</b></p> <p>Double-armed suture, measures 30cm in length. Reverse cut needle, measures 11.0mm in length, 3/8 curve, and 0.24mm in diameter.</p>	<p><b>Double-Armed Reverse Cut</b></p>  <table border="1"> <thead> <tr> <th colspan="2">Suture</th> </tr> </thead> <tbody> <tr> <td>Description</td> <td>Nylon, Black Mono</td> </tr> <tr> <td>Length (cm)</td> <td>30</td> </tr> <tr> <td>Size</td> <td>7-0 (0.5 metric)</td> </tr> </tbody> </table> <table border="1"> <thead> <tr> <th colspan="2">Needle</th> </tr> </thead> <tbody> <tr> <td>Length (mm)</td> <td>11.0</td> </tr> <tr> <td>Curve</td> <td>3/8</td> </tr> <tr> <td>Diam. (mm)</td> <td>0.24</td> </tr> </tbody> </table>	Suture		Description	Nylon, Black Mono	Length (cm)	30	Size	7-0 (0.5 metric)	Needle		Length (mm)	11.0	Curve	3/8	Diam. (mm)	0.24
Suture																		
Description	Nylon, Black Mono																	
Length (cm)	30																	
Size	7-0 (0.5 metric)																	
Needle																		
Length (mm)	11.0																	
Curve	3/8																	
Diam. (mm)	0.24																	
AB-2855	<p><b>Nylon Suture, Trape Spatula</b></p> <p>Double-armed suture, measures 45cm in length. Trape spatula needle, measures 8.0mm in length, 3/8 curve, and 0.28mm in diameter.</p>	<p><b>Double-Armed Trape Spatula</b></p>  <table border="1"> <thead> <tr> <th colspan="2">Suture</th> </tr> </thead> <tbody> <tr> <td>Description</td> <td>Nylon, Black Mono</td> </tr> <tr> <td>Length (cm)</td> <td>45</td> </tr> <tr> <td>Size</td> <td>7-0 (0.5 metric)</td> </tr> </tbody> </table> <table border="1"> <thead> <tr> <th colspan="2">Needle</th> </tr> </thead> <tbody> <tr> <td>Length (mm)</td> <td>8.0</td> </tr> <tr> <td>Curve</td> <td>3/8</td> </tr> <tr> <td>Diam. (mm)</td> <td>0.28</td> </tr> </tbody> </table>	Suture		Description	Nylon, Black Mono	Length (cm)	45	Size	7-0 (0.5 metric)	Needle		Length (mm)	8.0	Curve	3/8	Diam. (mm)	0.28
Suture																		
Description	Nylon, Black Mono																	
Length (cm)	45																	
Size	7-0 (0.5 metric)																	
Needle																		
Length (mm)	8.0																	
Curve	3/8																	
Diam. (mm)	0.28																	
AB-3364S	<p><b>Nylon Suture, Lancet</b></p> <p>Single-armed suture, measures 50cm in length. Lancet needle, measures 11.0mm in length, 3/8 curve, and 0.33mm in diameter.</p>	<p><b>Single-Armed Lancet</b></p>  <table border="1"> <thead> <tr> <th colspan="2">Suture</th> </tr> </thead> <tbody> <tr> <td>Description</td> <td>Nylon, Black Mono</td> </tr> <tr> <td>Length (cm)</td> <td>50</td> </tr> <tr> <td>Size</td> <td>7-0 (0.5 metric)</td> </tr> </tbody> </table> <table border="1"> <thead> <tr> <th colspan="2">Needle</th> </tr> </thead> <tbody> <tr> <td>Length (mm)</td> <td>11.0</td> </tr> <tr> <td>Curve</td> <td>3/8</td> </tr> <tr> <td>Diam. (mm)</td> <td>0.33</td> </tr> </tbody> </table>	Suture		Description	Nylon, Black Mono	Length (cm)	50	Size	7-0 (0.5 metric)	Needle		Length (mm)	11.0	Curve	3/8	Diam. (mm)	0.33
Suture																		
Description	Nylon, Black Mono																	
Length (cm)	50																	
Size	7-0 (0.5 metric)																	
Needle																		
Length (mm)	11.0																	
Curve	3/8																	
Diam. (mm)	0.33																	
AB-1457	<p><b>Nylon Suture, Trape Spatula</b></p> <p>Double-armed suture, measures 30cm in length. Trape spatula needle, measures 5.5mm in length, 7/16 curve, and 0.14mm in diameter.</p>	<p><b>Double-Armed Trape Spatula</b></p>  <table border="1"> <thead> <tr> <th colspan="2">Suture</th> </tr> </thead> <tbody> <tr> <td>Description</td> <td>Nylon, Black Mono</td> </tr> <tr> <td>Length (cm)</td> <td>30</td> </tr> <tr> <td>Size</td> <td>7-0 (0.5 metric)</td> </tr> </tbody> </table> <table border="1"> <thead> <tr> <th colspan="2">Needle</th> </tr> </thead> <tbody> <tr> <td>Length (mm)</td> <td>5.5</td> </tr> <tr> <td>Curve</td> <td>7/16</td> </tr> <tr> <td>Diam. (mm)</td> <td>0.14</td> </tr> </tbody> </table>	Suture		Description	Nylon, Black Mono	Length (cm)	30	Size	7-0 (0.5 metric)	Needle		Length (mm)	5.5	Curve	7/16	Diam. (mm)	0.14
Suture																		
Description	Nylon, Black Mono																	
Length (cm)	30																	
Size	7-0 (0.5 metric)																	
Needle																		
Length (mm)	5.5																	
Curve	7/16																	
Diam. (mm)	0.14																	
AB-3361	<p><b>Nylon Suture, Lancet</b></p> <p>Double-armed suture, measures 30cm in length. Lancet needle, measures 8.0mm in length, 3/8 curve, and 0.33mm in diameter.</p>	<p><b>Double-Armed Lancet</b></p>  <table border="1"> <thead> <tr> <th colspan="2">Suture</th> </tr> </thead> <tbody> <tr> <td>Description</td> <td>Nylon, Black Mono</td> </tr> <tr> <td>Length (cm)</td> <td>30</td> </tr> <tr> <td>Size</td> <td>7-0 (0.5 metric)</td> </tr> </tbody> </table> <table border="1"> <thead> <tr> <th colspan="2">Needle</th> </tr> </thead> <tbody> <tr> <td>Length (mm)</td> <td>8.0</td> </tr> <tr> <td>Curve</td> <td>3/8</td> </tr> <tr> <td>Diam. (mm)</td> <td>0.33</td> </tr> </tbody> </table>	Suture		Description	Nylon, Black Mono	Length (cm)	30	Size	7-0 (0.5 metric)	Needle		Length (mm)	8.0	Curve	3/8	Diam. (mm)	0.33
Suture																		
Description	Nylon, Black Mono																	
Length (cm)	30																	
Size	7-0 (0.5 metric)																	
Needle																		
Length (mm)	8.0																	
Curve	3/8																	
Diam. (mm)	0.33																	
AB-3361S	<p><b>Nylon Suture, Lancet</b></p> <p>Single-armed suture, measures 45cm in length. Lancet needle, measures 8.0mm in length, 3/8 curve, and 0.33mm in diameter.</p>	<p><b>Single-Armed Lancet</b></p>  <table border="1"> <thead> <tr> <th colspan="2">Suture</th> </tr> </thead> <tbody> <tr> <td>Description</td> <td>Nylon, Black Mono</td> </tr> <tr> <td>Length (cm)</td> <td>45</td> </tr> <tr> <td>Size</td> <td>7-0 (0.5 metric)</td> </tr> </tbody> </table> <table border="1"> <thead> <tr> <th colspan="2">Needle</th> </tr> </thead> <tbody> <tr> <td>Length (mm)</td> <td>8.0</td> </tr> <tr> <td>Curve</td> <td>3/8</td> </tr> <tr> <td>Diam. (mm)</td> <td>0.33</td> </tr> </tbody> </table>	Suture		Description	Nylon, Black Mono	Length (cm)	45	Size	7-0 (0.5 metric)	Needle		Length (mm)	8.0	Curve	3/8	Diam. (mm)	0.33
Suture																		
Description	Nylon, Black Mono																	
Length (cm)	45																	
Size	7-0 (0.5 metric)																	
Needle																		
Length (mm)	8.0																	
Curve	3/8																	
Diam. (mm)	0.33																	
AB-3364	<p><b>Nylon Suture, Lancet</b></p> <p>Double-armed suture, measures 50cm in length. Lancet needle, measures 11.0mm in length, 3/8 curve, and 0.33mm in diameter.</p>	<p><b>Double-Armed Lancet</b></p>  <table border="1"> <thead> <tr> <th colspan="2">Suture</th> </tr> </thead> <tbody> <tr> <td>Description</td> <td>Nylon, Black Mono</td> </tr> <tr> <td>Length (cm)</td> <td>50</td> </tr> <tr> <td>Size</td> <td>7-0 (0.5 metric)</td> </tr> </tbody> </table> <table border="1"> <thead> <tr> <th colspan="2">Needle</th> </tr> </thead> <tbody> <tr> <td>Length (mm)</td> <td>11.0</td> </tr> <tr> <td>Curve</td> <td>3/8</td> </tr> <tr> <td>Diam. (mm)</td> <td>0.33</td> </tr> </tbody> </table>	Suture		Description	Nylon, Black Mono	Length (cm)	50	Size	7-0 (0.5 metric)	Needle		Length (mm)	11.0	Curve	3/8	Diam. (mm)	0.33
Suture																		
Description	Nylon, Black Mono																	
Length (cm)	50																	
Size	7-0 (0.5 metric)																	
Needle																		
Length (mm)	11.0																	
Curve	3/8																	
Diam. (mm)	0.33																	

NYLON

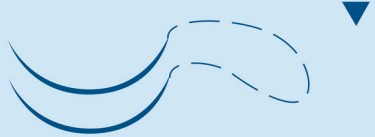
Item #	Description	Image
--------	-------------	-------

Sutures 6-0 Nylon

Mani brand 6-0, black mono, nylon sutures with both single and double arms. Trape spatula, lancet, cut taper, and reverse cut needles ranging in length, curve, and diameter. Mani sutures are ideal for micro-suturing on the cornea and sclera during eye surgery. Ultimate sharpness is obtained through the "cross-lapped edge" technique giving each suture a fine and sharp tip ensuring minimally invasive wound closure. Mani hard fiber stainless steel is used to make strong and break-resistant needles. Sold 12 per box.

AB-2808	<p><b>Nylon Suture, Reverse Cut</b></p> <p>Double-armed suture, measures 30cm in length. Reverse cut needle, measures 13.0mm in length, 3/8 curve, and 0.28mm in diameter.</p>	<p><b>Double-Armed Reverse Cut</b></p> 	<table border="1"> <thead> <tr> <th colspan="2">Suture</th> </tr> </thead> <tbody> <tr> <td>Description</td> <td>Nylon, Black Mono</td> </tr> <tr> <td>Length (cm)</td> <td>30</td> </tr> <tr> <td>Size</td> <td>6-0 (0.7 metric)</td> </tr> </tbody> </table> <table border="1"> <thead> <tr> <th colspan="2">Needle</th> </tr> </thead> <tbody> <tr> <td>Length (mm)</td> <td>13.0</td> </tr> <tr> <td>Curve</td> <td>3/8</td> </tr> <tr> <td>Diam. (mm)</td> <td>0.28</td> </tr> </tbody> </table>	Suture		Description	Nylon, Black Mono	Length (cm)	30	Size	6-0 (0.7 metric)	Needle		Length (mm)	13.0	Curve	3/8	Diam. (mm)	0.28
Suture																			
Description	Nylon, Black Mono																		
Length (cm)	30																		
Size	6-0 (0.7 metric)																		
Needle																			
Length (mm)	13.0																		
Curve	3/8																		
Diam. (mm)	0.28																		
AB-2808S	<p><b>Nylon Suture, Reverse Cut</b></p> <p>Single-armed suture, measures 20cm in length. Reverse cut needle, measures 13.0mm in length, 3/8 curve, and 0.28mm in diameter.</p>	<p><b>Single-Armed Reverse Cut</b></p> 	<table border="1"> <thead> <tr> <th colspan="2">Suture</th> </tr> </thead> <tbody> <tr> <td>Description</td> <td>Nylon, Black Mono</td> </tr> <tr> <td>Length (cm)</td> <td>20</td> </tr> <tr> <td>Size</td> <td>6-0 (0.7 metric)</td> </tr> </tbody> </table> <table border="1"> <thead> <tr> <th colspan="2">Needle</th> </tr> </thead> <tbody> <tr> <td>Length (mm)</td> <td>13.0</td> </tr> <tr> <td>Curve</td> <td>3/8</td> </tr> <tr> <td>Diam. (mm)</td> <td>0.28</td> </tr> </tbody> </table>	Suture		Description	Nylon, Black Mono	Length (cm)	20	Size	6-0 (0.7 metric)	Needle		Length (mm)	13.0	Curve	3/8	Diam. (mm)	0.28
Suture																			
Description	Nylon, Black Mono																		
Length (cm)	20																		
Size	6-0 (0.7 metric)																		
Needle																			
Length (mm)	13.0																		
Curve	3/8																		
Diam. (mm)	0.28																		
AB-2854	<p><b>Nylon Suture, Trape Spatula</b></p> <p>Double-armed suture, measures 45cm in length. Trape spatula needle, measures 8.0mm in length, 3/8 curve, and 0.28mm in diameter.</p>	<p><b>Double-Armed Trape Spatula</b></p> 	<table border="1"> <thead> <tr> <th colspan="2">Suture</th> </tr> </thead> <tbody> <tr> <td>Description</td> <td>Nylon, Black Mono</td> </tr> <tr> <td>Length (cm)</td> <td>45</td> </tr> <tr> <td>Size</td> <td>6-0 (0.7 metric)</td> </tr> </tbody> </table> <table border="1"> <thead> <tr> <th colspan="2">Needle</th> </tr> </thead> <tbody> <tr> <td>Length (mm)</td> <td>8.0</td> </tr> <tr> <td>Curve</td> <td>3/8</td> </tr> <tr> <td>Diam. (mm)</td> <td>0.28</td> </tr> </tbody> </table>	Suture		Description	Nylon, Black Mono	Length (cm)	45	Size	6-0 (0.7 metric)	Needle		Length (mm)	8.0	Curve	3/8	Diam. (mm)	0.28
Suture																			
Description	Nylon, Black Mono																		
Length (cm)	45																		
Size	6-0 (0.7 metric)																		
Needle																			
Length (mm)	8.0																		
Curve	3/8																		
Diam. (mm)	0.28																		
AB-3363S	<p><b>Nylon Suture, Lancet</b></p> <p>Single-armed suture, measures 45cm in length. Lancet needle, measures 13.0mm in length, 1/2 curve, and 0.33mm in diameter.</p>	<p><b>Single-Armed Lancet</b></p> 	<table border="1"> <thead> <tr> <th colspan="2">Suture</th> </tr> </thead> <tbody> <tr> <td>Description</td> <td>Nylon, Black Mono</td> </tr> <tr> <td>Length (cm)</td> <td>45</td> </tr> <tr> <td>Size</td> <td>6-0 (0.7 metric)</td> </tr> </tbody> </table> <table border="1"> <thead> <tr> <th colspan="2">Needle</th> </tr> </thead> <tbody> <tr> <td>Length (mm)</td> <td>13.0</td> </tr> <tr> <td>Curve</td> <td>1/2</td> </tr> <tr> <td>Diam. (mm)</td> <td>0.33</td> </tr> </tbody> </table>	Suture		Description	Nylon, Black Mono	Length (cm)	45	Size	6-0 (0.7 metric)	Needle		Length (mm)	13.0	Curve	1/2	Diam. (mm)	0.33
Suture																			
Description	Nylon, Black Mono																		
Length (cm)	45																		
Size	6-0 (0.7 metric)																		
Needle																			
Length (mm)	13.0																		
Curve	1/2																		
Diam. (mm)	0.33																		
AB-3379S	<p><b>Nylon Suture, Lancet</b></p> <p>Single-armed suture, measures 30cm in length. Lancet needle, measures 7.0mm in length, 3/8 curve, and 0.33mm in diameter.</p>	<p><b>Single-Armed Lancet</b></p> 	<table border="1"> <thead> <tr> <th colspan="2">Suture</th> </tr> </thead> <tbody> <tr> <td>Description</td> <td>Nylon, Black Mono</td> </tr> <tr> <td>Length (cm)</td> <td>30</td> </tr> <tr> <td>Size</td> <td>6-0 (0.7 metric)</td> </tr> </tbody> </table> <table border="1"> <thead> <tr> <th colspan="2">Needle</th> </tr> </thead> <tbody> <tr> <td>Length (mm)</td> <td>7.0</td> </tr> <tr> <td>Curve</td> <td>3/8</td> </tr> <tr> <td>Diam. (mm)</td> <td>0.33</td> </tr> </tbody> </table>	Suture		Description	Nylon, Black Mono	Length (cm)	30	Size	6-0 (0.7 metric)	Needle		Length (mm)	7.0	Curve	3/8	Diam. (mm)	0.33
Suture																			
Description	Nylon, Black Mono																		
Length (cm)	30																		
Size	6-0 (0.7 metric)																		
Needle																			
Length (mm)	7.0																		
Curve	3/8																		
Diam. (mm)	0.33																		
AB-3382	<p><b>Nylon Suture, Lancet</b></p> <p>Double-armed suture, measures 50cm in length. Lancet needle, measures 11.0mm in length, 3/8 curve, and 0.33mm in diameter.</p>	<p><b>Double-Armed Lancet</b></p> 	<table border="1"> <thead> <tr> <th colspan="2">Suture</th> </tr> </thead> <tbody> <tr> <td>Description</td> <td>Nylon, Black Mono</td> </tr> <tr> <td>Length (cm)</td> <td>50</td> </tr> <tr> <td>Size</td> <td>6-0 (0.7 metric)</td> </tr> </tbody> </table> <table border="1"> <thead> <tr> <th colspan="2">Needle</th> </tr> </thead> <tbody> <tr> <td>Length (mm)</td> <td>11.0</td> </tr> <tr> <td>Curve</td> <td>3/8</td> </tr> <tr> <td>Diam. (mm)</td> <td>0.33</td> </tr> </tbody> </table>	Suture		Description	Nylon, Black Mono	Length (cm)	50	Size	6-0 (0.7 metric)	Needle		Length (mm)	11.0	Curve	3/8	Diam. (mm)	0.33
Suture																			
Description	Nylon, Black Mono																		
Length (cm)	50																		
Size	6-0 (0.7 metric)																		
Needle																			
Length (mm)	11.0																		
Curve	3/8																		
Diam. (mm)	0.33																		
AB-3382S	<p><b>Nylon Suture, Lancet</b></p> <p>Single-armed suture, measures 45cm in length. Lancet needle, measures 11.0mm in length, 3/8 curve, and 0.33mm in diameter.</p>	<p><b>Single-Armed Lancet</b></p> 	<table border="1"> <thead> <tr> <th colspan="2">Suture</th> </tr> </thead> <tbody> <tr> <td>Description</td> <td>Nylon, Black Mono</td> </tr> <tr> <td>Length (cm)</td> <td>45</td> </tr> <tr> <td>Size</td> <td>6-0 (0.7 metric)</td> </tr> </tbody> </table> <table border="1"> <thead> <tr> <th colspan="2">Needle</th> </tr> </thead> <tbody> <tr> <td>Length (mm)</td> <td>11.0</td> </tr> <tr> <td>Curve</td> <td>3/8</td> </tr> <tr> <td>Diam. (mm)</td> <td>0.33</td> </tr> </tbody> </table>	Suture		Description	Nylon, Black Mono	Length (cm)	45	Size	6-0 (0.7 metric)	Needle		Length (mm)	11.0	Curve	3/8	Diam. (mm)	0.33
Suture																			
Description	Nylon, Black Mono																		
Length (cm)	45																		
Size	6-0 (0.7 metric)																		
Needle																			
Length (mm)	11.0																		
Curve	3/8																		
Diam. (mm)	0.33																		

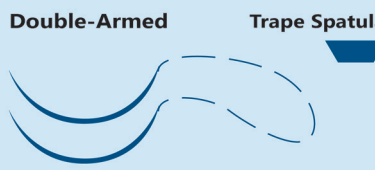
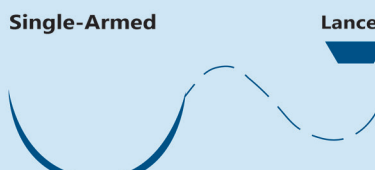
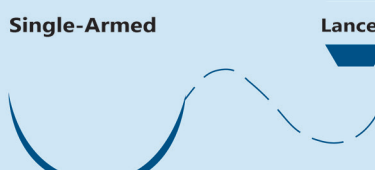
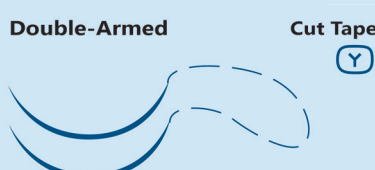
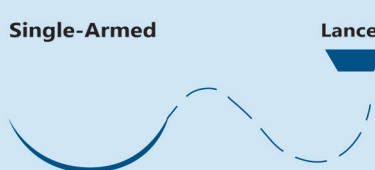

NYLON

Item #	Description	Image																
AB-2859	<p><b>Nylon Suture, Trape Spatula</b></p> <p>Double-armed suture, measures 45cm in length. Trape spatula needle, measures 8.0mm in length, 7/16 curve, and 0.28mm in diameter.</p>	 <table border="1"> <thead> <tr> <th colspan="2">Suture</th> </tr> </thead> <tbody> <tr> <td>Description</td> <td>Nylon, Black Mono</td> </tr> <tr> <td>Length (cm)</td> <td>45</td> </tr> <tr> <td>Size</td> <td>6-0 (0.7 metric)</td> </tr> </tbody> </table> <table border="1"> <thead> <tr> <th colspan="2">Needle</th> </tr> </thead> <tbody> <tr> <td>Length (mm)</td> <td>8.0</td> </tr> <tr> <td>Curve</td> <td>7/16</td> </tr> <tr> <td>Diam. (mm)</td> <td>0.28</td> </tr> </tbody> </table>	Suture		Description	Nylon, Black Mono	Length (cm)	45	Size	6-0 (0.7 metric)	Needle		Length (mm)	8.0	Curve	7/16	Diam. (mm)	0.28
Suture																		
Description	Nylon, Black Mono																	
Length (cm)	45																	
Size	6-0 (0.7 metric)																	
Needle																		
Length (mm)	8.0																	
Curve	7/16																	
Diam. (mm)	0.28																	
AB-3362S	<p><b>Nylon Suture, Lancet</b></p> <p>Single-armed suture, measures 50cm in length. Lancet needle, measures 8.0mm in length, 1/2 curve, and 0.33mm in diameter.</p>	 <table border="1"> <thead> <tr> <th colspan="2">Suture</th> </tr> </thead> <tbody> <tr> <td>Description</td> <td>Nylon, Black Mono</td> </tr> <tr> <td>Length (cm)</td> <td>50</td> </tr> <tr> <td>Size</td> <td>6-0 (0.7 metric)</td> </tr> </tbody> </table> <table border="1"> <thead> <tr> <th colspan="2">Needle</th> </tr> </thead> <tbody> <tr> <td>Length (mm)</td> <td>8.0</td> </tr> <tr> <td>Curve</td> <td>1/2</td> </tr> <tr> <td>Diam. (mm)</td> <td>0.33</td> </tr> </tbody> </table>	Suture		Description	Nylon, Black Mono	Length (cm)	50	Size	6-0 (0.7 metric)	Needle		Length (mm)	8.0	Curve	1/2	Diam. (mm)	0.33
Suture																		
Description	Nylon, Black Mono																	
Length (cm)	50																	
Size	6-0 (0.7 metric)																	
Needle																		
Length (mm)	8.0																	
Curve	1/2																	
Diam. (mm)	0.33																	
AB-3381S	<p><b>Nylon Suture, Lancet</b></p> <p>Single-armed suture, measures 45cm in length. Lancet needle, measures 11.0mm in length, 1/2 curve, and 0.33mm in diameter.</p>	 <table border="1"> <thead> <tr> <th colspan="2">Suture</th> </tr> </thead> <tbody> <tr> <td>Description</td> <td>Nylon, Black Mono</td> </tr> <tr> <td>Length (cm)</td> <td>45</td> </tr> <tr> <td>Size</td> <td>6-0 (0.7 metric)</td> </tr> </tbody> </table> <table border="1"> <thead> <tr> <th colspan="2">Needle</th> </tr> </thead> <tbody> <tr> <td>Length (mm)</td> <td>11.0</td> </tr> <tr> <td>Curve</td> <td>1/2</td> </tr> <tr> <td>Diam. (mm)</td> <td>0.33</td> </tr> </tbody> </table>	Suture		Description	Nylon, Black Mono	Length (cm)	45	Size	6-0 (0.7 metric)	Needle		Length (mm)	11.0	Curve	1/2	Diam. (mm)	0.33
Suture																		
Description	Nylon, Black Mono																	
Length (cm)	45																	
Size	6-0 (0.7 metric)																	
Needle																		
Length (mm)	11.0																	
Curve	1/2																	
Diam. (mm)	0.33																	
AB-3386	<p><b>Nylon Suture, Cut Taper</b></p> <p>Double-armed suture, measures 30cm in length. Cut taper needle, measures 15.0mm in length, 3/8 curve, and 0.33mm in diameter.</p>	 <table border="1"> <thead> <tr> <th colspan="2">Suture</th> </tr> </thead> <tbody> <tr> <td>Description</td> <td>Nylon, Black Mono</td> </tr> <tr> <td>Length (cm)</td> <td>30</td> </tr> <tr> <td>Size</td> <td>6-0 (0.7 metric)</td> </tr> </tbody> </table> <table border="1"> <thead> <tr> <th colspan="2">Needle</th> </tr> </thead> <tbody> <tr> <td>Length (mm)</td> <td>15.0</td> </tr> <tr> <td>Curve</td> <td>3/8</td> </tr> <tr> <td>Diam. (mm)</td> <td>0.33</td> </tr> </tbody> </table>	Suture		Description	Nylon, Black Mono	Length (cm)	30	Size	6-0 (0.7 metric)	Needle		Length (mm)	15.0	Curve	3/8	Diam. (mm)	0.33
Suture																		
Description	Nylon, Black Mono																	
Length (cm)	30																	
Size	6-0 (0.7 metric)																	
Needle																		
Length (mm)	15.0																	
Curve	3/8																	
Diam. (mm)	0.33																	
AB-3853S	<p><b>Nylon Suture, Lancet</b></p> <p>Single-armed suture, measures 45cm in length. Lancet needle, measures 11.0mm in length, 3/8 curve, and 0.38mm in diameter.</p>	 <table border="1"> <thead> <tr> <th colspan="2">Suture</th> </tr> </thead> <tbody> <tr> <td>Description</td> <td>Nylon, Black Mono</td> </tr> <tr> <td>Length (cm)</td> <td>45</td> </tr> <tr> <td>Size</td> <td>6-0 (0.7 metric)</td> </tr> </tbody> </table> <table border="1"> <thead> <tr> <th colspan="2">Needle</th> </tr> </thead> <tbody> <tr> <td>Length (mm)</td> <td>11.0</td> </tr> <tr> <td>Curve</td> <td>3/8</td> </tr> <tr> <td>Diam. (mm)</td> <td>0.38</td> </tr> </tbody> </table>	Suture		Description	Nylon, Black Mono	Length (cm)	45	Size	6-0 (0.7 metric)	Needle		Length (mm)	11.0	Curve	3/8	Diam. (mm)	0.38
Suture																		
Description	Nylon, Black Mono																	
Length (cm)	45																	
Size	6-0 (0.7 metric)																	
Needle																		
Length (mm)	11.0																	
Curve	3/8																	
Diam. (mm)	0.38																	

Sutures 5-0 Nylon

Mani brand 5-0, black mono, nylon sutures with both single and double arms. Lancet, reverse cut, dia spatula, and trape spatula needles ranging in length, curve, and diameter. Mani sutures are ideal for micro-suturing on the cornea and sclera during eye surgery. Ultimate sharpness is obtained through the "cross-lapped edge" technique giving each suture a fine and sharp tip ensuring minimally invasive wound closure. Mani hard fiber stainless steel is used to make strong and break-resistant needles. Sold 12 per box.

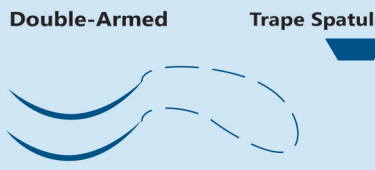
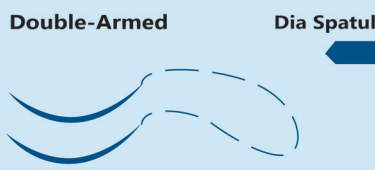
AB-2806	<p><b>Nylon Suture, Trape Spatula</b></p> <p>Double-armed suture, measures 30cm in length. Trape spatula needle, measures 6.0mm in length, 1/4 curve, and 0.28mm in diameter.</p>	 <table border="1"> <thead> <tr> <th colspan="2">Suture</th> </tr> </thead> <tbody> <tr> <td>Description</td> <td>Nylon, Black Mono</td> </tr> <tr> <td>Length (cm)</td> <td>30</td> </tr> <tr> <td>Size</td> <td>5-0 (1.0 metric)</td> </tr> </tbody> </table> <table border="1"> <thead> <tr> <th colspan="2">Needle</th> </tr> </thead> <tbody> <tr> <td>Length (mm)</td> <td>6.0</td> </tr> <tr> <td>Curve</td> <td>1/4</td> </tr> <tr> <td>Diam. (mm)</td> <td>0.28</td> </tr> </tbody> </table>	Suture		Description	Nylon, Black Mono	Length (cm)	30	Size	5-0 (1.0 metric)	Needle		Length (mm)	6.0	Curve	1/4	Diam. (mm)	0.28
Suture																		
Description	Nylon, Black Mono																	
Length (cm)	30																	
Size	5-0 (1.0 metric)																	
Needle																		
Length (mm)	6.0																	
Curve	1/4																	
Diam. (mm)	0.28																	
AB-2807	<p><b>Nylon Suture, Dia Spatula</b></p> <p>Double-armed suture, measures 45cm in length. Dia spatula needle, measures 6.0mm in length, 1/4 curve, and 0.28mm in diameter.</p>	 <table border="1"> <thead> <tr> <th colspan="2">Suture</th> </tr> </thead> <tbody> <tr> <td>Description</td> <td>Nylon, Black Mono</td> </tr> <tr> <td>Length (cm)</td> <td>45</td> </tr> <tr> <td>Size</td> <td>5-0 (1.0 metric)</td> </tr> </tbody> </table> <table border="1"> <thead> <tr> <th colspan="2">Needle</th> </tr> </thead> <tbody> <tr> <td>Length (mm)</td> <td>6.0</td> </tr> <tr> <td>Curve</td> <td>1/4</td> </tr> <tr> <td>Diam. (mm)</td> <td>0.28</td> </tr> </tbody> </table>	Suture		Description	Nylon, Black Mono	Length (cm)	45	Size	5-0 (1.0 metric)	Needle		Length (mm)	6.0	Curve	1/4	Diam. (mm)	0.28
Suture																		
Description	Nylon, Black Mono																	
Length (cm)	45																	
Size	5-0 (1.0 metric)																	
Needle																		
Length (mm)	6.0																	
Curve	1/4																	
Diam. (mm)	0.28																	

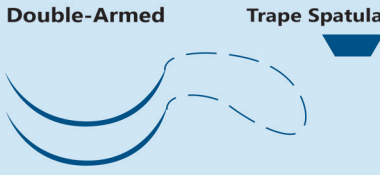
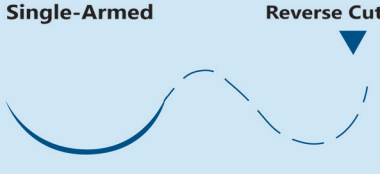
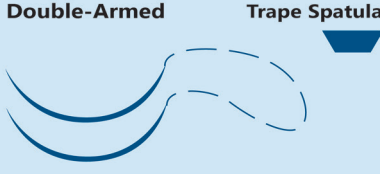
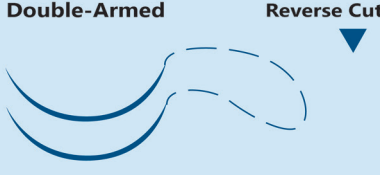
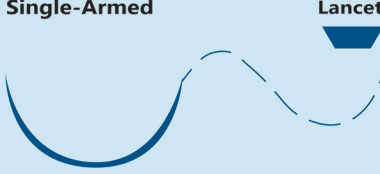

NYLON

Item #	Description	Image																
AB-2856	<p><b>Nylon Suture, Trape Spatula</b></p> <p>Double-armed suture, measures 45cm in length. Trape spatula needle, measures 8.0mm in length, 3/8 curve, and 0.28mm in diameter.</p>	 <table border="1"> <thead> <tr> <th colspan="2">Suture</th> </tr> </thead> <tbody> <tr> <td>Description</td> <td>Nylon, Black Mono</td> </tr> <tr> <td>Length (cm)</td> <td>45</td> </tr> <tr> <td>Size</td> <td>5-0 (1.0 metric)</td> </tr> </tbody> </table> <table border="1"> <thead> <tr> <th colspan="2">Needle</th> </tr> </thead> <tbody> <tr> <td>Length (mm)</td> <td>8.0</td> </tr> <tr> <td>Curve</td> <td>3/8</td> </tr> <tr> <td>Diam. (mm)</td> <td>0.28</td> </tr> </tbody> </table>	Suture		Description	Nylon, Black Mono	Length (cm)	45	Size	5-0 (1.0 metric)	Needle		Length (mm)	8.0	Curve	3/8	Diam. (mm)	0.28
Suture																		
Description	Nylon, Black Mono																	
Length (cm)	45																	
Size	5-0 (1.0 metric)																	
Needle																		
Length (mm)	8.0																	
Curve	3/8																	
Diam. (mm)	0.28																	
AB-3854S	<p><b>Nylon Suture, Reverse Cut</b></p> <p>Single-armed suture, measures 45cm in length. Reverse cut needle, measures 11.0mm in length, 3/8 curve, and 0.38mm in diameter.</p>	 <table border="1"> <thead> <tr> <th colspan="2">Suture</th> </tr> </thead> <tbody> <tr> <td>Description</td> <td>Nylon, Black Mono</td> </tr> <tr> <td>Length (cm)</td> <td>45</td> </tr> <tr> <td>Size</td> <td>5-0 (1.0 metric)</td> </tr> </tbody> </table> <table border="1"> <thead> <tr> <th colspan="2">Needle</th> </tr> </thead> <tbody> <tr> <td>Length (mm)</td> <td>11.0</td> </tr> <tr> <td>Curve</td> <td>3/8</td> </tr> <tr> <td>Diam. (mm)</td> <td>0.38</td> </tr> </tbody> </table>	Suture		Description	Nylon, Black Mono	Length (cm)	45	Size	5-0 (1.0 metric)	Needle		Length (mm)	11.0	Curve	3/8	Diam. (mm)	0.38
Suture																		
Description	Nylon, Black Mono																	
Length (cm)	45																	
Size	5-0 (1.0 metric)																	
Needle																		
Length (mm)	11.0																	
Curve	3/8																	
Diam. (mm)	0.38																	
AB-2865	<p><b>Nylon Suture, Trape Spatula</b></p> <p>Double-armed suture, measures 45cm in length. Trape spatula needle, measures 7.0mm in length, 3/8 curve, and 0.28mm in diameter.</p>	 <table border="1"> <thead> <tr> <th colspan="2">Suture</th> </tr> </thead> <tbody> <tr> <td>Description</td> <td>Nylon, Black Mono</td> </tr> <tr> <td>Length (cm)</td> <td>45</td> </tr> <tr> <td>Size</td> <td>5-0 (1.0 metric)</td> </tr> </tbody> </table> <table border="1"> <thead> <tr> <th colspan="2">Needle</th> </tr> </thead> <tbody> <tr> <td>Length (mm)</td> <td>7.0</td> </tr> <tr> <td>Curve</td> <td>3/8</td> </tr> <tr> <td>Diam. (mm)</td> <td>0.28</td> </tr> </tbody> </table>	Suture		Description	Nylon, Black Mono	Length (cm)	45	Size	5-0 (1.0 metric)	Needle		Length (mm)	7.0	Curve	3/8	Diam. (mm)	0.28
Suture																		
Description	Nylon, Black Mono																	
Length (cm)	45																	
Size	5-0 (1.0 metric)																	
Needle																		
Length (mm)	7.0																	
Curve	3/8																	
Diam. (mm)	0.28																	
AB-3854	<p><b>Nylon Suture, Reverse Cut</b></p> <p>Double-armed suture, measures 50cm in length. Reverse cut needle, measures 11.0mm in length, 3/8 curve, and 0.38mm in diameter.</p>	 <table border="1"> <thead> <tr> <th colspan="2">Suture</th> </tr> </thead> <tbody> <tr> <td>Description</td> <td>Nylon, Black Mono</td> </tr> <tr> <td>Length (cm)</td> <td>50</td> </tr> <tr> <td>Size</td> <td>5-0 (1.0 metric)</td> </tr> </tbody> </table> <table border="1"> <thead> <tr> <th colspan="2">Needle</th> </tr> </thead> <tbody> <tr> <td>Length (mm)</td> <td>11.0</td> </tr> <tr> <td>Curve</td> <td>3/8</td> </tr> <tr> <td>Diam. (mm)</td> <td>0.38</td> </tr> </tbody> </table>	Suture		Description	Nylon, Black Mono	Length (cm)	50	Size	5-0 (1.0 metric)	Needle		Length (mm)	11.0	Curve	3/8	Diam. (mm)	0.38
Suture																		
Description	Nylon, Black Mono																	
Length (cm)	50																	
Size	5-0 (1.0 metric)																	
Needle																		
Length (mm)	11.0																	
Curve	3/8																	
Diam. (mm)	0.38																	
AB-3383S	<p><b>Nylon Suture, Lancet</b></p> <p>Single-armed suture, measures 45cm in length. Lancet needle, measures 11.0mm in length, 1/2 curve, and 0.33mm in diameter.</p>	 <table border="1"> <thead> <tr> <th colspan="2">Suture</th> </tr> </thead> <tbody> <tr> <td>Description</td> <td>Nylon, Black Mono</td> </tr> <tr> <td>Length (cm)</td> <td>45</td> </tr> <tr> <td>Size</td> <td>5-0 (1.0 metric)</td> </tr> </tbody> </table> <table border="1"> <thead> <tr> <th colspan="2">Needle</th> </tr> </thead> <tbody> <tr> <td>Length (mm)</td> <td>11.0</td> </tr> <tr> <td>Curve</td> <td>1/2</td> </tr> <tr> <td>Diam. (mm)</td> <td>0.33</td> </tr> </tbody> </table>	Suture		Description	Nylon, Black Mono	Length (cm)	45	Size	5-0 (1.0 metric)	Needle		Length (mm)	11.0	Curve	1/2	Diam. (mm)	0.33
Suture																		
Description	Nylon, Black Mono																	
Length (cm)	45																	
Size	5-0 (1.0 metric)																	
Needle																		
Length (mm)	11.0																	
Curve	1/2																	
Diam. (mm)	0.33																	

POLYESTER

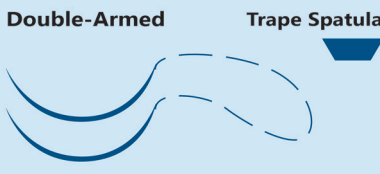
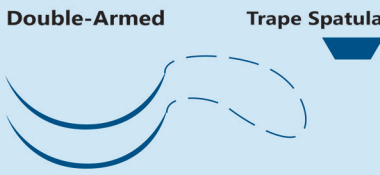
Item #	Description	Image																
<b>Sutures 10-0 Polyester</b>																		
<p>Mani brand 10-0, green mono, polyester sutures with double arms. Trape spatula needles ranging in length, curve, and diameter. Mani sutures are ideal for micro-suturing on the cornea and sclera during eye surgery. Ultimate sharpness is obtained through the "cross-lapped edge" technique giving each suture a fine and sharp tip ensuring minimally invasive wound closure. Mani hard fiber stainless steel is used to make strong and break-resistant needles. Sold 12 per box.</p>																		
AB-1411	<p><b>Polyester Suture, Trape Spatula</b></p> <p>Double-armed suture, measures 30cm in length. Trape spatula needle, measures 5.5mm in length, 7/16 curve, and 0.14mm in diameter.</p>	 <table border="1"> <thead> <tr> <th colspan="2">Suture</th> </tr> </thead> <tbody> <tr> <td>Description</td> <td>Polyester, Green Mono</td> </tr> <tr> <td>Length (cm)</td> <td>30</td> </tr> <tr> <td>Size</td> <td>10-0 (0.2 metric)</td> </tr> </tbody> </table> <table border="1"> <thead> <tr> <th colspan="2">Needle</th> </tr> </thead> <tbody> <tr> <td>Length (mm)</td> <td>5.5</td> </tr> <tr> <td>Curve</td> <td>7/16</td> </tr> <tr> <td>Diam. (mm)</td> <td>0.14</td> </tr> </tbody> </table>	Suture		Description	Polyester, Green Mono	Length (cm)	30	Size	10-0 (0.2 metric)	Needle		Length (mm)	5.5	Curve	7/16	Diam. (mm)	0.14
Suture																		
Description	Polyester, Green Mono																	
Length (cm)	30																	
Size	10-0 (0.2 metric)																	
Needle																		
Length (mm)	5.5																	
Curve	7/16																	
Diam. (mm)	0.14																	
AB-2017	<p><b>Polyester Suture, Trape Spatula</b></p> <p>Double-armed suture, measures 30cm in length. Trape spatula needle, measures 6.5mm in length, 3/8 curve, and 0.20mm in diameter.</p>	 <table border="1"> <thead> <tr> <th colspan="2">Suture</th> </tr> </thead> <tbody> <tr> <td>Description</td> <td>Polyester, Green Mono</td> </tr> <tr> <td>Length (cm)</td> <td>30</td> </tr> <tr> <td>Size</td> <td>10-0 (0.2 metric)</td> </tr> </tbody> </table> <table border="1"> <thead> <tr> <th colspan="2">Needle</th> </tr> </thead> <tbody> <tr> <td>Length (mm)</td> <td>6.5</td> </tr> <tr> <td>Curve</td> <td>3/8</td> </tr> <tr> <td>Diam. (mm)</td> <td>0.20</td> </tr> </tbody> </table>	Suture		Description	Polyester, Green Mono	Length (cm)	30	Size	10-0 (0.2 metric)	Needle		Length (mm)	6.5	Curve	3/8	Diam. (mm)	0.20
Suture																		
Description	Polyester, Green Mono																	
Length (cm)	30																	
Size	10-0 (0.2 metric)																	
Needle																		
Length (mm)	6.5																	
Curve	3/8																	
Diam. (mm)	0.20																	

POLYESTER

Item #	Description	Image	Suture	Needle												
AB-1412	<b>Polyester Suture, Trape Spatula</b> Double-armed suture, measures 30cm in length. Trape spatula needle, measures 6.0mm in length, 3/8 curve, and 0.14mm in diameter.		<table border="1"> <tr><td>Description</td><td>Polyester, Green Mono</td></tr> <tr><td>Length (cm)</td><td>30</td></tr> <tr><td>Size</td><td>10-0 (0.2 metric)</td></tr> </table>	Description	Polyester, Green Mono	Length (cm)	30	Size	10-0 (0.2 metric)	<table border="1"> <tr><td>Length (mm)</td><td>6.0</td></tr> <tr><td>Curve</td><td>3/8</td></tr> <tr><td>Diam. (mm)</td><td>0.14</td></tr> </table>	Length (mm)	6.0	Curve	3/8	Diam. (mm)	0.14
Description	Polyester, Green Mono															
Length (cm)	30															
Size	10-0 (0.2 metric)															
Length (mm)	6.0															
Curve	3/8															
Diam. (mm)	0.14															

Sutures 5-0 Polyester

Mani brand 5-0, green or white braided, polyester sutures with double arms. Trape spatula, dia spatula, and taper point needles ranging in length, curve, and diameter. Mani sutures are ideal for micro-suturing on the cornea and sclera during eye surgery. Ultimate sharpness is obtained through the "cross-lapped edge" technique giving each suture a fine and sharp tip ensuring minimally invasive wound closure. Mani hard fiber stainless steel is used to make strong and break-resistant needles. Sold 12 per box.

AB-2863	<b>Polyester Suture, Dia Spatula</b> White braided, double-armed suture, measures 45cm in length. Dia spatula needle, measures 6.0mm in length, 1/4 curve, and 0.28mm in diameter.		<table border="1"> <tr><td>Description</td><td>Polyester, White Braided</td></tr> <tr><td>Length (cm)</td><td>45</td></tr> <tr><td>Size</td><td>5-0 (1.0 metric)</td></tr> </table>	Description	Polyester, White Braided	Length (cm)	45	Size	5-0 (1.0 metric)	<table border="1"> <tr><td>Length (mm)</td><td>6.0</td></tr> <tr><td>Curve</td><td>1/4</td></tr> <tr><td>Diam. (mm)</td><td>0.28</td></tr> </table>	Length (mm)	6.0	Curve	1/4	Diam. (mm)	0.28
Description	Polyester, White Braided															
Length (cm)	45															
Size	5-0 (1.0 metric)															
Length (mm)	6.0															
Curve	1/4															
Diam. (mm)	0.28															
AB-3370	<b>Polyester Suture, Dia Spatula</b> White braided, double-armed suture, measures 45cm in length. Dia spatula needle, measures 8.0mm in length, 1/4 curve, and 0.33mm in diameter.		<table border="1"> <tr><td>Description</td><td>Polyester, White Braided</td></tr> <tr><td>Length (cm)</td><td>45</td></tr> <tr><td>Size</td><td>5-0 (1.0 metric)</td></tr> </table>	Description	Polyester, White Braided	Length (cm)	45	Size	5-0 (1.0 metric)	<table border="1"> <tr><td>Length (mm)</td><td>8.0</td></tr> <tr><td>Curve</td><td>1/4</td></tr> <tr><td>Diam. (mm)</td><td>0.33</td></tr> </table>	Length (mm)	8.0	Curve	1/4	Diam. (mm)	0.33
Description	Polyester, White Braided															
Length (cm)	45															
Size	5-0 (1.0 metric)															
Length (mm)	8.0															
Curve	1/4															
Diam. (mm)	0.33															
AB-3376	<b>Polyester Suture, Trape Spatula</b> Green braided, double-armed suture, measures 45cm in length. Trape spatula needle, measures 8.0mm in length, 1/4 curve, and 0.33mm in diameter.		<table border="1"> <tr><td>Description</td><td>Polyester, Green Braided</td></tr> <tr><td>Length (cm)</td><td>45</td></tr> <tr><td>Size</td><td>5-0 (1.0 metric)</td></tr> </table>	Description	Polyester, Green Braided	Length (cm)	45	Size	5-0 (1.0 metric)	<table border="1"> <tr><td>Length (mm)</td><td>8.0</td></tr> <tr><td>Curve</td><td>1/4</td></tr> <tr><td>Diam. (mm)</td><td>0.33</td></tr> </table>	Length (mm)	8.0	Curve	1/4	Diam. (mm)	0.33
Description	Polyester, Green Braided															
Length (cm)	45															
Size	5-0 (1.0 metric)															
Length (mm)	8.0															
Curve	1/4															
Diam. (mm)	0.33															
AB-3377	<b>Polyester Suture, Trape Spatula</b> White braided, double-armed suture, measures 45cm in length. Trape spatula needle, measures 8.0mm in length, 1/4 curve, and 0.33mm in diameter.		<table border="1"> <tr><td>Description</td><td>Polyester, White Braided</td></tr> <tr><td>Length (cm)</td><td>45</td></tr> <tr><td>Size</td><td>5-0 (1.0 metric)</td></tr> </table>	Description	Polyester, White Braided	Length (cm)	45	Size	5-0 (1.0 metric)	<table border="1"> <tr><td>Length (mm)</td><td>8.0</td></tr> <tr><td>Curve</td><td>1/4</td></tr> <tr><td>Diam. (mm)</td><td>0.33</td></tr> </table>	Length (mm)	8.0	Curve	1/4	Diam. (mm)	0.33
Description	Polyester, White Braided															
Length (cm)	45															
Size	5-0 (1.0 metric)															
Length (mm)	8.0															
Curve	1/4															
Diam. (mm)	0.33															
AB-3371	<b>Polyester Suture, Dia Spatula</b> White braided, double-armed suture, measures 45cm in length. Dia spatula needle, measures 8.0mm in length, 1/2 curve, and 0.33mm in diameter.		<table border="1"> <tr><td>Description</td><td>Polyester, White Braided</td></tr> <tr><td>Length (cm)</td><td>45</td></tr> <tr><td>Size</td><td>5-0 (1.0 metric)</td></tr> </table>	Description	Polyester, White Braided	Length (cm)	45	Size	5-0 (1.0 metric)	<table border="1"> <tr><td>Length (mm)</td><td>8.0</td></tr> <tr><td>Curve</td><td>1/2</td></tr> <tr><td>Diam. (mm)</td><td>0.33</td></tr> </table>	Length (mm)	8.0	Curve	1/2	Diam. (mm)	0.33
Description	Polyester, White Braided															
Length (cm)	45															
Size	5-0 (1.0 metric)															
Length (mm)	8.0															
Curve	1/2															
Diam. (mm)	0.33															
AB-3372	<b>Polyester Suture, Dia Spatula</b> White braided, double-armed suture, measures 45cm in length. Dia spatula needle, measures 6.0mm in length, 1/4 curve, and 0.33mm in diameter.		<table border="1"> <tr><td>Description</td><td>Polyester, White Braided</td></tr> <tr><td>Length (cm)</td><td>45</td></tr> <tr><td>Size</td><td>5-0 (1.0 metric)</td></tr> </table>	Description	Polyester, White Braided	Length (cm)	45	Size	5-0 (1.0 metric)	<table border="1"> <tr><td>Length (mm)</td><td>6.0</td></tr> <tr><td>Curve</td><td>1/4</td></tr> <tr><td>Diam. (mm)</td><td>0.33</td></tr> </table>	Length (mm)	6.0	Curve	1/4	Diam. (mm)	0.33
Description	Polyester, White Braided															
Length (cm)	45															
Size	5-0 (1.0 metric)															
Length (mm)	6.0															
Curve	1/4															
Diam. (mm)	0.33															

POLYESTER

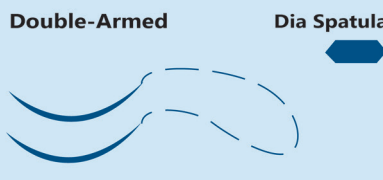
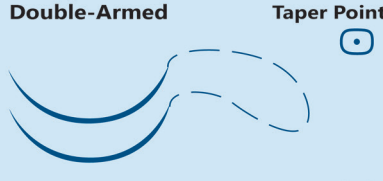
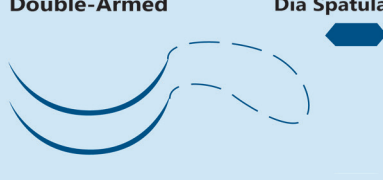
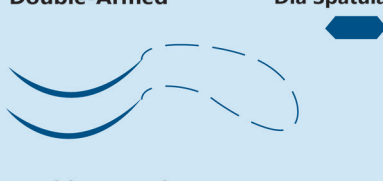
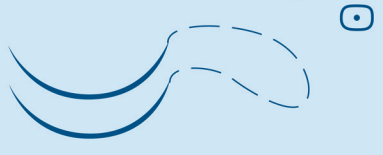
Item #	Description	Image																
AB-3373	<p><b>Polyester Suture, Dia Spatula</b></p> <p>Green braided, double-armed suture, measures 45cm in length. Dia spatula needle, measures 8.0mm in length, 1/4 curve, and 0.33mm in diameter.</p>	 <table border="1"> <thead> <tr> <th colspan="2">Suture</th> </tr> </thead> <tbody> <tr> <td>Description</td> <td>Polyester, Green Braided</td> </tr> <tr> <td>Length (cm)</td> <td>45</td> </tr> <tr> <td>Size</td> <td>5-0 (1.0 metric)</td> </tr> </tbody> </table> <table border="1"> <thead> <tr> <th colspan="2">Needle</th> </tr> </thead> <tbody> <tr> <td>Length (mm)</td> <td>8.0</td> </tr> <tr> <td>Curve</td> <td>1/4</td> </tr> <tr> <td>Diam. (mm)</td> <td>0.33</td> </tr> </tbody> </table>	Suture		Description	Polyester, Green Braided	Length (cm)	45	Size	5-0 (1.0 metric)	Needle		Length (mm)	8.0	Curve	1/4	Diam. (mm)	0.33
Suture																		
Description	Polyester, Green Braided																	
Length (cm)	45																	
Size	5-0 (1.0 metric)																	
Needle																		
Length (mm)	8.0																	
Curve	1/4																	
Diam. (mm)	0.33																	
AB-3380	<p><b>Polyester Suture, Taper Point</b></p> <p>White braided, double-armed suture, measures 75cm in length. Taper point needle, measures 10.0mm in length, 3/8 curve, and 0.33mm in diameter.</p>	 <table border="1"> <thead> <tr> <th colspan="2">Suture</th> </tr> </thead> <tbody> <tr> <td>Description</td> <td>Polyester, White Braided</td> </tr> <tr> <td>Length (cm)</td> <td>75</td> </tr> <tr> <td>Size</td> <td>5-0 (1.0 metric)</td> </tr> </tbody> </table> <table border="1"> <thead> <tr> <th colspan="2">Needle</th> </tr> </thead> <tbody> <tr> <td>Length (mm)</td> <td>10.0</td> </tr> <tr> <td>Curve</td> <td>3/8</td> </tr> <tr> <td>Diam. (mm)</td> <td>0.33</td> </tr> </tbody> </table>	Suture		Description	Polyester, White Braided	Length (cm)	75	Size	5-0 (1.0 metric)	Needle		Length (mm)	10.0	Curve	3/8	Diam. (mm)	0.33
Suture																		
Description	Polyester, White Braided																	
Length (cm)	75																	
Size	5-0 (1.0 metric)																	
Needle																		
Length (mm)	10.0																	
Curve	3/8																	
Diam. (mm)	0.33																	
AB-3374	<p><b>Polyester Suture, Dia Spatula</b></p> <p>Green braided, double-armed suture, measures 45cm in length. Dia spatula needle, measures 8.0mm in length, 1/4 curve, and 0.33mm in diameter.</p>	 <table border="1"> <thead> <tr> <th colspan="2">Suture</th> </tr> </thead> <tbody> <tr> <td>Description</td> <td>Polyester, Green Braided</td> </tr> <tr> <td>Length (cm)</td> <td>45</td> </tr> <tr> <td>Size</td> <td>5-0 (1.0 metric)</td> </tr> </tbody> </table> <table border="1"> <thead> <tr> <th colspan="2">Needle</th> </tr> </thead> <tbody> <tr> <td>Length (mm)</td> <td>8.0</td> </tr> <tr> <td>Curve</td> <td>1/4</td> </tr> <tr> <td>Diam. (mm)</td> <td>0.33</td> </tr> </tbody> </table>	Suture		Description	Polyester, Green Braided	Length (cm)	45	Size	5-0 (1.0 metric)	Needle		Length (mm)	8.0	Curve	1/4	Diam. (mm)	0.33
Suture																		
Description	Polyester, Green Braided																	
Length (cm)	45																	
Size	5-0 (1.0 metric)																	
Needle																		
Length (mm)	8.0																	
Curve	1/4																	
Diam. (mm)	0.33																	
AB-3375	<p><b>Polyester Suture, Dia Spatula</b></p> <p>Green braided, double-armed suture, measures 45cm in length. Dia spatula needle, measures 6.0mm in length, 1/4 curve, and 0.33mm in diameter.</p>	 <table border="1"> <thead> <tr> <th colspan="2">Suture</th> </tr> </thead> <tbody> <tr> <td>Description</td> <td>Polyester, Green Braided</td> </tr> <tr> <td>Length (cm)</td> <td>45</td> </tr> <tr> <td>Size</td> <td>5-0 (1.0 metric)</td> </tr> </tbody> </table> <table border="1"> <thead> <tr> <th colspan="2">Needle</th> </tr> </thead> <tbody> <tr> <td>Length (mm)</td> <td>6.0</td> </tr> <tr> <td>Curve</td> <td>1/4</td> </tr> <tr> <td>Diam. (mm)</td> <td>0.33</td> </tr> </tbody> </table>	Suture		Description	Polyester, Green Braided	Length (cm)	45	Size	5-0 (1.0 metric)	Needle		Length (mm)	6.0	Curve	1/4	Diam. (mm)	0.33
Suture																		
Description	Polyester, Green Braided																	
Length (cm)	45																	
Size	5-0 (1.0 metric)																	
Needle																		
Length (mm)	6.0																	
Curve	1/4																	
Diam. (mm)	0.33																	
AB-3378	<p><b>Polyester Suture, Taper Point</b></p> <p>Green braided, double-armed suture, measures 75cm in length. Taper point needle, measures 10.0mm in length, 3/8 curve, and 0.33mm in diameter.</p>	 <table border="1"> <thead> <tr> <th colspan="2">Suture</th> </tr> </thead> <tbody> <tr> <td>Description</td> <td>Polyester, Green Braided</td> </tr> <tr> <td>Length (cm)</td> <td>75</td> </tr> <tr> <td>Size</td> <td>5-0 (1.0 metric)</td> </tr> </tbody> </table> <table border="1"> <thead> <tr> <th colspan="2">Needle</th> </tr> </thead> <tbody> <tr> <td>Length (mm)</td> <td>10.0</td> </tr> <tr> <td>Curve</td> <td>3/8</td> </tr> <tr> <td>Diam. (mm)</td> <td>0.33</td> </tr> </tbody> </table>	Suture		Description	Polyester, Green Braided	Length (cm)	75	Size	5-0 (1.0 metric)	Needle		Length (mm)	10.0	Curve	3/8	Diam. (mm)	0.33
Suture																		
Description	Polyester, Green Braided																	
Length (cm)	75																	
Size	5-0 (1.0 metric)																	
Needle																		
Length (mm)	10.0																	
Curve	3/8																	
Diam. (mm)	0.33																	

Sutures 4-0 Polyester

Mani brand 4-0, green or white braided, polyester sutures with double arms. Trape spatula and dia spatula needles ranging in length, curve, and diameter. Mani sutures are ideal for micro-suturing on the cornea and sclera during eye surgery. Ultimate sharpness is obtained through the "cross-lapped edge" technique giving each suture a fine and sharp tip ensuring minimally invasive wound closure. Mani hard fiber stainless steel is used to make strong and break-resistant needles. Sold 12 per box.

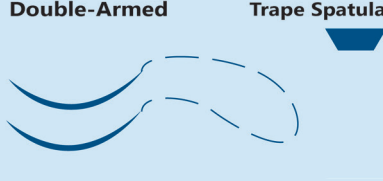
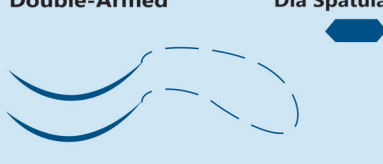
AB-4355	<p><b>Polyester Suture, Trape Spatula</b></p> <p>Green braided, double-armed suture, measures 45cm in length. Trape spatula needle, measures 8.0mm in length, 1/4 curve, and 0.43mm in diameter.</p>	 <table border="1"> <thead> <tr> <th colspan="2">Suture</th> </tr> </thead> <tbody> <tr> <td>Description</td> <td>Polyester, Green Braided</td> </tr> <tr> <td>Length (cm)</td> <td>45</td> </tr> <tr> <td>Size</td> <td>4-0 (1.5 metric)</td> </tr> </tbody> </table> <table border="1"> <thead> <tr> <th colspan="2">Needle</th> </tr> </thead> <tbody> <tr> <td>Length (mm)</td> <td>8.0</td> </tr> <tr> <td>Curve</td> <td>1/4</td> </tr> <tr> <td>Diam. (mm)</td> <td>0.43</td> </tr> </tbody> </table>	Suture		Description	Polyester, Green Braided	Length (cm)	45	Size	4-0 (1.5 metric)	Needle		Length (mm)	8.0	Curve	1/4	Diam. (mm)	0.43
Suture																		
Description	Polyester, Green Braided																	
Length (cm)	45																	
Size	4-0 (1.5 metric)																	
Needle																		
Length (mm)	8.0																	
Curve	1/4																	
Diam. (mm)	0.43																	
AB-4353	<p><b>Polyester Suture, Dia Spatula</b></p> <p>Green braided, double-armed suture, measures 45cm in length. Dia spatula needle, measures 8.0mm in length, 1/4 curve, and 0.43mm in diameter.</p>	 <table border="1"> <thead> <tr> <th colspan="2">Suture</th> </tr> </thead> <tbody> <tr> <td>Description</td> <td>Polyester, Green Braided</td> </tr> <tr> <td>Length (cm)</td> <td>45</td> </tr> <tr> <td>Size</td> <td>4-0 (1.5 metric)</td> </tr> </tbody> </table> <table border="1"> <thead> <tr> <th colspan="2">Needle</th> </tr> </thead> <tbody> <tr> <td>Length (mm)</td> <td>8.0</td> </tr> <tr> <td>Curve</td> <td>1/4</td> </tr> <tr> <td>Diam. (mm)</td> <td>0.43</td> </tr> </tbody> </table>	Suture		Description	Polyester, Green Braided	Length (cm)	45	Size	4-0 (1.5 metric)	Needle		Length (mm)	8.0	Curve	1/4	Diam. (mm)	0.43
Suture																		
Description	Polyester, Green Braided																	
Length (cm)	45																	
Size	4-0 (1.5 metric)																	
Needle																		
Length (mm)	8.0																	
Curve	1/4																	
Diam. (mm)	0.43																	

POLYESTER

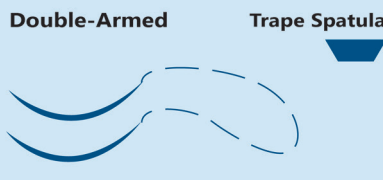
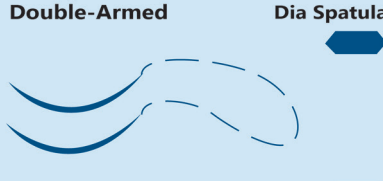
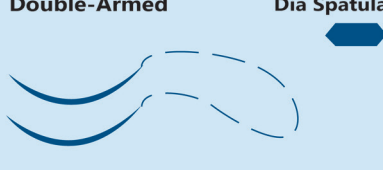
Item #	Description	Image																
AB-4356	<p><b>Polyester Suture, Trape Spatula</b></p> <p>White braided, double-armed suture, measures 45cm in length. Trape spatula needle, measures 8.0mm in length, 1/4 curve, and 0.43mm in diameter.</p>	 <table border="1"> <thead> <tr> <th colspan="2">Suture</th> </tr> </thead> <tbody> <tr> <td>Description</td> <td>Polyester, White Braided</td> </tr> <tr> <td>Length (cm)</td> <td>45</td> </tr> <tr> <td>Size</td> <td>4-0 (1.5 metric)</td> </tr> </tbody> </table> <table border="1"> <thead> <tr> <th colspan="2">Needle</th> </tr> </thead> <tbody> <tr> <td>Length (mm)</td> <td>8.0</td> </tr> <tr> <td>Curve</td> <td>1/4</td> </tr> <tr> <td>Diam. (mm)</td> <td>0.43</td> </tr> </tbody> </table>	Suture		Description	Polyester, White Braided	Length (cm)	45	Size	4-0 (1.5 metric)	Needle		Length (mm)	8.0	Curve	1/4	Diam. (mm)	0.43
Suture																		
Description	Polyester, White Braided																	
Length (cm)	45																	
Size	4-0 (1.5 metric)																	
Needle																		
Length (mm)	8.0																	
Curve	1/4																	
Diam. (mm)	0.43																	
AB-4357	<p><b>Polyester Suture, Dia Spatula</b></p> <p>White braided, double-armed suture, measures 45cm in length. Dia spatula needle, measures 6.5mm in length, 1/4 curve, and 0.43mm in diameter.</p>	 <table border="1"> <thead> <tr> <th colspan="2">Suture</th> </tr> </thead> <tbody> <tr> <td>Description</td> <td>Polyester, White Braided</td> </tr> <tr> <td>Length (cm)</td> <td>45</td> </tr> <tr> <td>Size</td> <td>4-0 (1.5 metric)</td> </tr> </tbody> </table> <table border="1"> <thead> <tr> <th colspan="2">Needle</th> </tr> </thead> <tbody> <tr> <td>Length (mm)</td> <td>6.5</td> </tr> <tr> <td>Curve</td> <td>1/4</td> </tr> <tr> <td>Diam. (mm)</td> <td>0.43</td> </tr> </tbody> </table>	Suture		Description	Polyester, White Braided	Length (cm)	45	Size	4-0 (1.5 metric)	Needle		Length (mm)	6.5	Curve	1/4	Diam. (mm)	0.43
Suture																		
Description	Polyester, White Braided																	
Length (cm)	45																	
Size	4-0 (1.5 metric)																	
Needle																		
Length (mm)	6.5																	
Curve	1/4																	
Diam. (mm)	0.43																	
AB-4352	<p><b>Polyester Suture, Dia Spatula</b></p> <p>White braided, double-armed suture, measures 45cm in length. Dia spatula needle, measures 8.0mm in length, 1/4 curve, and 0.43mm in diameter.</p>	 <table border="1"> <thead> <tr> <th colspan="2">Suture</th> </tr> </thead> <tbody> <tr> <td>Description</td> <td>Polyester, White Braided</td> </tr> <tr> <td>Length (cm)</td> <td>45</td> </tr> <tr> <td>Size</td> <td>4-0 (1.5 metric)</td> </tr> </tbody> </table> <table border="1"> <thead> <tr> <th colspan="2">Needle</th> </tr> </thead> <tbody> <tr> <td>Length (mm)</td> <td>8.0</td> </tr> <tr> <td>Curve</td> <td>1/4</td> </tr> <tr> <td>Diam. (mm)</td> <td>0.43</td> </tr> </tbody> </table>	Suture		Description	Polyester, White Braided	Length (cm)	45	Size	4-0 (1.5 metric)	Needle		Length (mm)	8.0	Curve	1/4	Diam. (mm)	0.43
Suture																		
Description	Polyester, White Braided																	
Length (cm)	45																	
Size	4-0 (1.5 metric)																	
Needle																		
Length (mm)	8.0																	
Curve	1/4																	
Diam. (mm)	0.43																	

POLYGLYCOLIC ACID

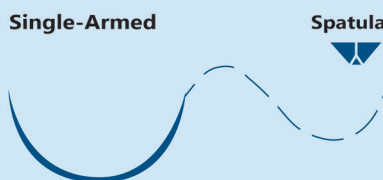
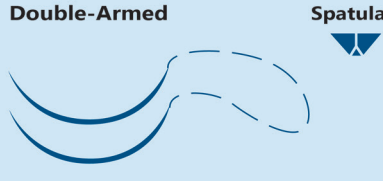
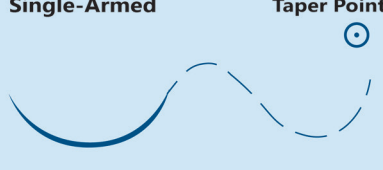
Item #	Description	Image																
<b>Sutures 10-0 Polyglycolic Acid</b>																		
<p>Peters brand 10-0, violet braided, polyglycolic acid sutures with single and double arms. Spatula and taper point needles ranging in length, curve, and diameter. Sinus Point is the brand of sutures manufactured by Peters Surgical, with years of experience, exceptional know-how, and a 100% quality control guaranteeing an excellent product recognized by the best surgeons around the world. Sinus Point micro-needles are manufactured with the highest medical stainless steel AISI 304V. This material makes Peters sutures unbreakable. Sold 12 per box.</p>																		
AXI4039	<p><b>PGA Suture, Spatula</b></p> <p>Single-armed suture, measures 30cm in length. Spatula needle, measures 6.0mm in length, 1/2 curve, and 0.15mm in diameter.</p>	 <table border="1"> <thead> <tr> <th colspan="2">Suture</th> </tr> </thead> <tbody> <tr> <td>Description</td> <td>Polyglycolic Acid, Violet Braid</td> </tr> <tr> <td>Length (cm)</td> <td>30</td> </tr> <tr> <td>Size</td> <td>10-0 (0.2 metric)</td> </tr> </tbody> </table> <table border="1"> <thead> <tr> <th colspan="2">Needle</th> </tr> </thead> <tbody> <tr> <td>Length (mm)</td> <td>6.0</td> </tr> <tr> <td>Curve</td> <td>1/2</td> </tr> <tr> <td>Diam. (mm)</td> <td>0.15</td> </tr> </tbody> </table>	Suture		Description	Polyglycolic Acid, Violet Braid	Length (cm)	30	Size	10-0 (0.2 metric)	Needle		Length (mm)	6.0	Curve	1/2	Diam. (mm)	0.15
Suture																		
Description	Polyglycolic Acid, Violet Braid																	
Length (cm)	30																	
Size	10-0 (0.2 metric)																	
Needle																		
Length (mm)	6.0																	
Curve	1/2																	
Diam. (mm)	0.15																	
AXI4040	<p><b>PGA Suture, Spatula</b></p> <p>Double-armed suture, measures 30cm in length. Spatula needle, measures 6.4mm in length, 3/8 curve, and 0.20mm in diameter.</p>	 <table border="1"> <thead> <tr> <th colspan="2">Suture</th> </tr> </thead> <tbody> <tr> <td>Description</td> <td>Polyglycolic Acid, Violet Braid</td> </tr> <tr> <td>Length (cm)</td> <td>30</td> </tr> <tr> <td>Size</td> <td>10-0 (0.2 metric)</td> </tr> </tbody> </table> <table border="1"> <thead> <tr> <th colspan="2">Needle</th> </tr> </thead> <tbody> <tr> <td>Length (mm)</td> <td>6.4</td> </tr> <tr> <td>Curve</td> <td>3/8</td> </tr> <tr> <td>Diam. (mm)</td> <td>0.20</td> </tr> </tbody> </table>	Suture		Description	Polyglycolic Acid, Violet Braid	Length (cm)	30	Size	10-0 (0.2 metric)	Needle		Length (mm)	6.4	Curve	3/8	Diam. (mm)	0.20
Suture																		
Description	Polyglycolic Acid, Violet Braid																	
Length (cm)	30																	
Size	10-0 (0.2 metric)																	
Needle																		
Length (mm)	6.4																	
Curve	3/8																	
Diam. (mm)	0.20																	
AB-8137	<p><b>PGA Suture, Taper Point</b></p> <p>Single-armed suture, measures 15cm in length. Taper point needle, measures 5.0mm in length, 3/8 curve, and 0.20mm in diameter.</p>	 <table border="1"> <thead> <tr> <th colspan="2">Suture</th> </tr> </thead> <tbody> <tr> <td>Description</td> <td>Polyglycolic Acid, Violet Braid</td> </tr> <tr> <td>Length (cm)</td> <td>15</td> </tr> <tr> <td>Size</td> <td>10-0 (0.2 metric)</td> </tr> </tbody> </table> <table border="1"> <thead> <tr> <th colspan="2">Needle</th> </tr> </thead> <tbody> <tr> <td>Length (mm)</td> <td>5.0</td> </tr> <tr> <td>Curve</td> <td>3/8</td> </tr> <tr> <td>Diam. (mm)</td> <td>0.20</td> </tr> </tbody> </table>	Suture		Description	Polyglycolic Acid, Violet Braid	Length (cm)	15	Size	10-0 (0.2 metric)	Needle		Length (mm)	5.0	Curve	3/8	Diam. (mm)	0.20
Suture																		
Description	Polyglycolic Acid, Violet Braid																	
Length (cm)	15																	
Size	10-0 (0.2 metric)																	
Needle																		
Length (mm)	5.0																	
Curve	3/8																	
Diam. (mm)	0.20																	

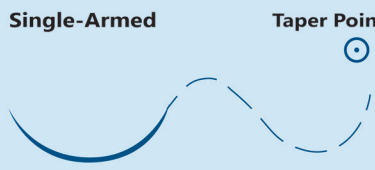

POLYGLYCOLIC ACID

Item #	Description	Image	Suture																
AXI4510	<p><b>PGA Suture, Taper Point</b></p> <p>Single-armed suture, measures 30cm in length. Taper point needle, measures 4.0mm in length, 3/8 curve, and 0.20mm in diameter.</p>	<p><b>Single-Armed Taper Point</b></p> 	<table border="1"> <tr><th colspan="2">Suture</th></tr> <tr><td>Description</td><td>Polyglycolic Acid, Violet Braid</td></tr> <tr><td>Length (cm)</td><td>30</td></tr> <tr><td>Size</td><td>10-0 (0.2 metric)</td></tr> <tr><th colspan="2">Needle</th></tr> <tr><td>Length (mm)</td><td>4.0</td></tr> <tr><td>Curve</td><td>3/8</td></tr> <tr><td>Diam. (mm)</td><td>0.20</td></tr> </table>	Suture		Description	Polyglycolic Acid, Violet Braid	Length (cm)	30	Size	10-0 (0.2 metric)	Needle		Length (mm)	4.0	Curve	3/8	Diam. (mm)	0.20
Suture																			
Description	Polyglycolic Acid, Violet Braid																		
Length (cm)	30																		
Size	10-0 (0.2 metric)																		
Needle																			
Length (mm)	4.0																		
Curve	3/8																		
Diam. (mm)	0.20																		

Sutures 9-0 Polyglycolic Acid

Peters brand 9-0, violet braided, polyglycolic acid sutures with single and double arms. Spatula needles ranging in length, curve, and diameter. Sinus Point is the brand of sutures manufactured by Peters Surgical, with years of experience, exceptional know-how, and a 100% quality control guaranteeing an excellent product recognized by the best surgeons around the world. Sinus Point micro-needles are manufactured with the highest medical stainless steel AISI 304V. This material makes Peters sutures unbreakable. Sold 12 per box.

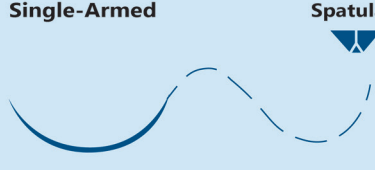
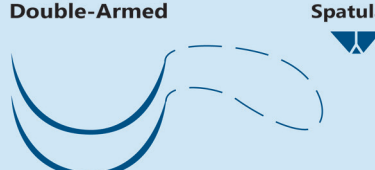
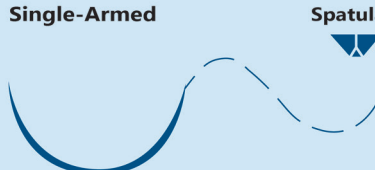
AXI4041	<p><b>PGA Suture, Spatula</b></p> <p>Single-armed suture, measures 30cm in length. Spatula needle, measures 6.4mm in length, 3/8 curve, and 0.20mm in diameter.</p>	<p><b>Single-Armed Spatula</b></p> 	<table border="1"> <tr><th colspan="2">Suture</th></tr> <tr><td>Description</td><td>Polyglycolic Acid, Violet Braid</td></tr> <tr><td>Length (cm)</td><td>30</td></tr> <tr><td>Size</td><td>9-0 (0.3 metric)</td></tr> <tr><th colspan="2">Needle</th></tr> <tr><td>Length (mm)</td><td>6.4</td></tr> <tr><td>Curve</td><td>3/8</td></tr> <tr><td>Diam. (mm)</td><td>0.20</td></tr> </table>	Suture		Description	Polyglycolic Acid, Violet Braid	Length (cm)	30	Size	9-0 (0.3 metric)	Needle		Length (mm)	6.4	Curve	3/8	Diam. (mm)	0.20
Suture																			
Description	Polyglycolic Acid, Violet Braid																		
Length (cm)	30																		
Size	9-0 (0.3 metric)																		
Needle																			
Length (mm)	6.4																		
Curve	3/8																		
Diam. (mm)	0.20																		
AXI4043	<p><b>PGA Suture, Spatula</b></p> <p>Double-armed suture, measures 30cm in length. Spatula needle, measures 6.0mm in length, 1/2 curve, and 0.15mm in diameter.</p>	<p><b>Double-Armed Spatula</b></p> 	<table border="1"> <tr><th colspan="2">Suture</th></tr> <tr><td>Description</td><td>Polyglycolic Acid, Violet Braid</td></tr> <tr><td>Length (cm)</td><td>30</td></tr> <tr><td>Size</td><td>9-0 (0.3 metric)</td></tr> <tr><th colspan="2">Needle</th></tr> <tr><td>Length (mm)</td><td>6.0</td></tr> <tr><td>Curve</td><td>1/2</td></tr> <tr><td>Diam. (mm)</td><td>0.15</td></tr> </table>	Suture		Description	Polyglycolic Acid, Violet Braid	Length (cm)	30	Size	9-0 (0.3 metric)	Needle		Length (mm)	6.0	Curve	1/2	Diam. (mm)	0.15
Suture																			
Description	Polyglycolic Acid, Violet Braid																		
Length (cm)	30																		
Size	9-0 (0.3 metric)																		
Needle																			
Length (mm)	6.0																		
Curve	1/2																		
Diam. (mm)	0.15																		
AXI4042	<p><b>PGA Suture, Spatula</b></p> <p>Single-armed suture, measures 30cm in length. Spatula needle, measures 6.0mm in length, 1/2 curve, and 0.15mm in diameter.</p>	<p><b>Single-Armed Spatula</b></p> 	<table border="1"> <tr><th colspan="2">Suture</th></tr> <tr><td>Description</td><td>Polyglycolic Acid, Violet Braid</td></tr> <tr><td>Length (cm)</td><td>30</td></tr> <tr><td>Size</td><td>9-0 (0.3 metric)</td></tr> <tr><th colspan="2">Needle</th></tr> <tr><td>Length (mm)</td><td>6.0</td></tr> <tr><td>Curve</td><td>1/2</td></tr> <tr><td>Diam. (mm)</td><td>0.15</td></tr> </table>	Suture		Description	Polyglycolic Acid, Violet Braid	Length (cm)	30	Size	9-0 (0.3 metric)	Needle		Length (mm)	6.0	Curve	1/2	Diam. (mm)	0.15
Suture																			
Description	Polyglycolic Acid, Violet Braid																		
Length (cm)	30																		
Size	9-0 (0.3 metric)																		
Needle																			
Length (mm)	6.0																		
Curve	1/2																		
Diam. (mm)	0.15																		

Sutures 8-0 Polyglycolic Acid

Peters and Mani brand 8-0, violet braided, polyglycolic acid sutures with single and double arms. Spatula, trape spatula, and taper point needles ranging in length, curve, and diameter. Mani and Peters brand sutures are high-quality products with strong and break-resistant needles. Sold 12 per box.

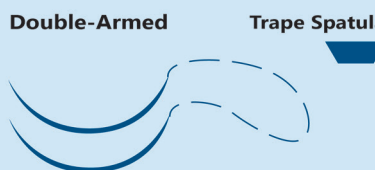
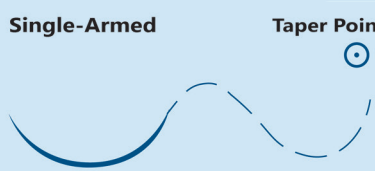
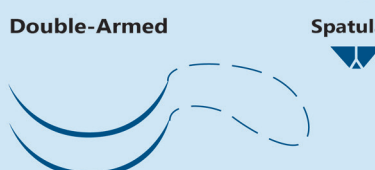
AB-2090	<p><b>PGA Suture, Spatula</b></p> <p>Double-armed suture, measures 30cm in length. Trape spatula needle, measures 6.5mm in length, 3/8 curve, and 0.20mm in diameter. Manufactured by Mani.</p>	<p><b>Double-Armed Trape Spatula</b></p> 	<table border="1"> <tr><th colspan="2">Suture</th></tr> <tr><td>Description</td><td>Polyglycolic Acid, Violet Braid</td></tr> <tr><td>Length (cm)</td><td>30</td></tr> <tr><td>Size</td><td>8-0 (0.4 metric)</td></tr> <tr><th colspan="2">Needle</th></tr> <tr><td>Length (mm)</td><td>6.5</td></tr> <tr><td>Curve</td><td>3/8</td></tr> <tr><td>Diam. (mm)</td><td>0.20</td></tr> </table>	Suture		Description	Polyglycolic Acid, Violet Braid	Length (cm)	30	Size	8-0 (0.4 metric)	Needle		Length (mm)	6.5	Curve	3/8	Diam. (mm)	0.20
Suture																			
Description	Polyglycolic Acid, Violet Braid																		
Length (cm)	30																		
Size	8-0 (0.4 metric)																		
Needle																			
Length (mm)	6.5																		
Curve	3/8																		
Diam. (mm)	0.20																		
AB-8109	<p><b>PGA Suture, Taper Point</b></p> <p>Single-armed suture, measures 30cm in length. Taper point needle, measures 6.4mm in length, 3/8 curve, and 0.40mm in diameter. Manufactured by Peters.</p>	<p><b>Single-Armed Taper Point</b></p> 	<table border="1"> <tr><th colspan="2">Suture</th></tr> <tr><td>Description</td><td>Polyglycolic Acid, Violet Braid</td></tr> <tr><td>Length (cm)</td><td>30</td></tr> <tr><td>Size</td><td>8-0 (0.4 metric)</td></tr> <tr><th colspan="2">Needle</th></tr> <tr><td>Length (mm)</td><td>6.4</td></tr> <tr><td>Curve</td><td>3/8</td></tr> <tr><td>Diam. (mm)</td><td>0.40</td></tr> </table>	Suture		Description	Polyglycolic Acid, Violet Braid	Length (cm)	30	Size	8-0 (0.4 metric)	Needle		Length (mm)	6.4	Curve	3/8	Diam. (mm)	0.40
Suture																			
Description	Polyglycolic Acid, Violet Braid																		
Length (cm)	30																		
Size	8-0 (0.4 metric)																		
Needle																			
Length (mm)	6.4																		
Curve	3/8																		
Diam. (mm)	0.40																		
AB-8112	<p><b>PGASuture, Spatula</b></p> <p>Double-armed suture, measures 30cm in length. Spatula needle, measures 6.4mm in length, 3/8 curve, and 0.40mm in diameter. Manufactured by Peters.</p>	<p><b>Double-Armed Spatula</b></p> 	<table border="1"> <tr><th colspan="2">Suture</th></tr> <tr><td>Description</td><td>Polyglycolic Acid, Violet Braid</td></tr> <tr><td>Length (cm)</td><td>30</td></tr> <tr><td>Size</td><td>8-0 (0.4 metric)</td></tr> <tr><th colspan="2">Needle</th></tr> <tr><td>Length (mm)</td><td>6.4</td></tr> <tr><td>Curve</td><td>3/8</td></tr> <tr><td>Diam. (mm)</td><td>0.40</td></tr> </table>	Suture		Description	Polyglycolic Acid, Violet Braid	Length (cm)	30	Size	8-0 (0.4 metric)	Needle		Length (mm)	6.4	Curve	3/8	Diam. (mm)	0.40
Suture																			
Description	Polyglycolic Acid, Violet Braid																		
Length (cm)	30																		
Size	8-0 (0.4 metric)																		
Needle																			
Length (mm)	6.4																		
Curve	3/8																		
Diam. (mm)	0.40																		

POLYGLYCOLIC ACID

Item #	Description	Image
--------	-------------	-------

Sutures 7-0 Polyglycolic Acid

Peters and Mani brand 7-0, violet braided, polyglycolic acid sutures with single and double arms. Spatula and trape spatula needles ranging in length, curve, and diameter. Mani and Peters brand sutures are high-quality products with strong and break-resistant needles. Sold 12 per box.

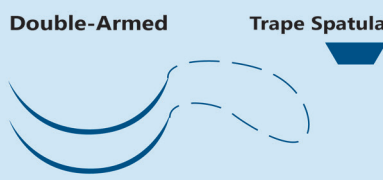
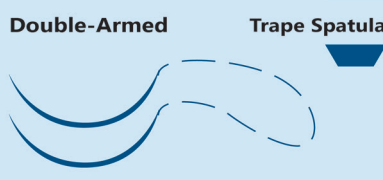
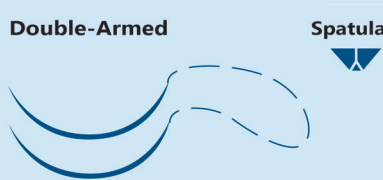
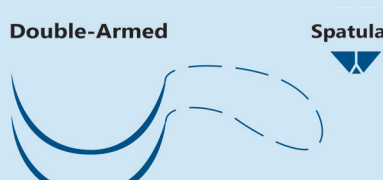
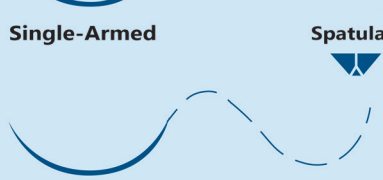
AB-2091	<b>PGA Suture, Trape Spatula</b> Double-armed suture, measures 30cm in length. Trape spatula needle, measures 6.5mm in length, 3/8 curve, and 0.20mm in diameter. Manufactured by Mani.	 <p><b>Double-Armed Trape Spatula</b></p>	<table border="1"> <thead> <tr> <th colspan="2">Suture</th> </tr> </thead> <tbody> <tr> <td>Description</td> <td>Polyglycolic Acid, Violet Braid</td> </tr> <tr> <td>Length (cm)</td> <td>30</td> </tr> <tr> <td>Size</td> <td>7-0 (0.5 metric)</td> </tr> </tbody> </table> <table border="1"> <thead> <tr> <th colspan="2">Needle</th> </tr> </thead> <tbody> <tr> <td>Length (mm)</td> <td>6.5</td> </tr> <tr> <td>Curve</td> <td>3/8</td> </tr> <tr> <td>Diam. (mm)</td> <td>0.20</td> </tr> </tbody> </table>	Suture		Description	Polyglycolic Acid, Violet Braid	Length (cm)	30	Size	7-0 (0.5 metric)	Needle		Length (mm)	6.5	Curve	3/8	Diam. (mm)	0.20
Suture																			
Description	Polyglycolic Acid, Violet Braid																		
Length (cm)	30																		
Size	7-0 (0.5 metric)																		
Needle																			
Length (mm)	6.5																		
Curve	3/8																		
Diam. (mm)	0.20																		
AB-2092	<b>PGA Suture, Trape Spatula</b> Double-armed suture, measures 45cm in length. Trape spatula needle, measures 5.5mm in length, 7/16 curve, and 0.20mm in diameter. Manufactured by Mani.	 <p><b>Double-Armed Trape Spatula</b></p>	<table border="1"> <thead> <tr> <th colspan="2">Suture</th> </tr> </thead> <tbody> <tr> <td>Description</td> <td>Polyglycolic Acid, Violet Braid</td> </tr> <tr> <td>Length (cm)</td> <td>45</td> </tr> <tr> <td>Size</td> <td>7-0 (0.5 metric)</td> </tr> </tbody> </table> <table border="1"> <thead> <tr> <th colspan="2">Needle</th> </tr> </thead> <tbody> <tr> <td>Length (mm)</td> <td>5.5</td> </tr> <tr> <td>Curve</td> <td>7/16</td> </tr> <tr> <td>Diam. (mm)</td> <td>0.20</td> </tr> </tbody> </table>	Suture		Description	Polyglycolic Acid, Violet Braid	Length (cm)	45	Size	7-0 (0.5 metric)	Needle		Length (mm)	5.5	Curve	7/16	Diam. (mm)	0.20
Suture																			
Description	Polyglycolic Acid, Violet Braid																		
Length (cm)	45																		
Size	7-0 (0.5 metric)																		
Needle																			
Length (mm)	5.5																		
Curve	7/16																		
Diam. (mm)	0.20																		
AB-8111	<b>PGA Suture, Spatula</b> Double-armed suture, measures 45cm in length. Spatula needle, measures 6.4mm in length, 3/8 curve, and 0.50mm in diameter. Manufactured by Peters.	 <p><b>Double-Armed Spatula</b></p>	<table border="1"> <thead> <tr> <th colspan="2">Suture</th> </tr> </thead> <tbody> <tr> <td>Description</td> <td>Polyglycolic Acid, Violet Braid</td> </tr> <tr> <td>Length (cm)</td> <td>45</td> </tr> <tr> <td>Size</td> <td>7-0 (0.5 metric)</td> </tr> </tbody> </table> <table border="1"> <thead> <tr> <th colspan="2">Needle</th> </tr> </thead> <tbody> <tr> <td>Length (mm)</td> <td>6.4</td> </tr> <tr> <td>Curve</td> <td>3/8</td> </tr> <tr> <td>Diam. (mm)</td> <td>0.50</td> </tr> </tbody> </table>	Suture		Description	Polyglycolic Acid, Violet Braid	Length (cm)	45	Size	7-0 (0.5 metric)	Needle		Length (mm)	6.4	Curve	3/8	Diam. (mm)	0.50
Suture																			
Description	Polyglycolic Acid, Violet Braid																		
Length (cm)	45																		
Size	7-0 (0.5 metric)																		
Needle																			
Length (mm)	6.4																		
Curve	3/8																		
Diam. (mm)	0.50																		
AB-8126	<b>PGA Suture, Spatula</b> Double-armed suture, measures 30cm in length. Spatula needle, measures 6.0mm in length, 1/2 curve, and 0.50mm in diameter. Manufactured by Peters.	 <p><b>Double-Armed Spatula</b></p>	<table border="1"> <thead> <tr> <th colspan="2">Suture</th> </tr> </thead> <tbody> <tr> <td>Description</td> <td>Polyglycolic Acid, Violet Braid</td> </tr> <tr> <td>Length (cm)</td> <td>30</td> </tr> <tr> <td>Size</td> <td>7-0 (0.5 metric)</td> </tr> </tbody> </table> <table border="1"> <thead> <tr> <th colspan="2">Needle</th> </tr> </thead> <tbody> <tr> <td>Length (mm)</td> <td>6.0</td> </tr> <tr> <td>Curve</td> <td>1/2</td> </tr> <tr> <td>Diam. (mm)</td> <td>0.50</td> </tr> </tbody> </table>	Suture		Description	Polyglycolic Acid, Violet Braid	Length (cm)	30	Size	7-0 (0.5 metric)	Needle		Length (mm)	6.0	Curve	1/2	Diam. (mm)	0.50
Suture																			
Description	Polyglycolic Acid, Violet Braid																		
Length (cm)	30																		
Size	7-0 (0.5 metric)																		
Needle																			
Length (mm)	6.0																		
Curve	1/2																		
Diam. (mm)	0.50																		
AB-8102	<b>PGA Suture, Spatula</b> Single-armed suture, measures 30cm in length. Spatula needle, measures 6.4mm in length, 3/8 curve, and 0.50mm in diameter. Manufactured by Peters.	 <p><b>Single-Armed Spatula</b></p>	<table border="1"> <thead> <tr> <th colspan="2">Suture</th> </tr> </thead> <tbody> <tr> <td>Description</td> <td>Polyglycolic Acid, Violet Braid</td> </tr> <tr> <td>Length (cm)</td> <td>30</td> </tr> <tr> <td>Size</td> <td>7-0 (0.5 metric)</td> </tr> </tbody> </table> <table border="1"> <thead> <tr> <th colspan="2">Needle</th> </tr> </thead> <tbody> <tr> <td>Length (mm)</td> <td>6.4</td> </tr> <tr> <td>Curve</td> <td>3/8</td> </tr> <tr> <td>Diam. (mm)</td> <td>0.50</td> </tr> </tbody> </table>	Suture		Description	Polyglycolic Acid, Violet Braid	Length (cm)	30	Size	7-0 (0.5 metric)	Needle		Length (mm)	6.4	Curve	3/8	Diam. (mm)	0.50
Suture																			
Description	Polyglycolic Acid, Violet Braid																		
Length (cm)	30																		
Size	7-0 (0.5 metric)																		
Needle																			
Length (mm)	6.4																		
Curve	3/8																		
Diam. (mm)	0.50																		

Sutures 6-0 Polyglycolic Acid

Peters and Mani brand 6-0, violet braided, polyglycolic acid sutures with single and double arms. Dia spatula, trape spatula, spatula, and reverse cut needles ranging in length, curve, and diameter. Mani and Peters brand sutures are high-quality products with strong and break-resistant needles. Sold 12 per box.

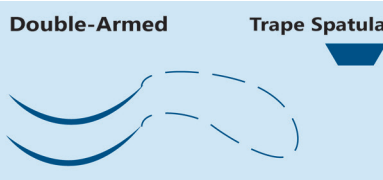
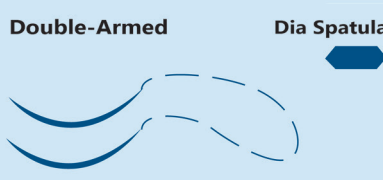
AB-2490	<b>PGA Suture, Trape Spatula</b> Double-armed suture, measures 45cm in length. Trape spatula needle, measures 6.5mm in length, 1/4 curve, and 0.24mm in diameter. Manufactured by Mani.	 <p><b>Double-Armed Trape Spatula</b></p>	<table border="1"> <thead> <tr> <th colspan="2">Suture</th> </tr> </thead> <tbody> <tr> <td>Description</td> <td>Polyglycolic Acid, Violet Braid</td> </tr> <tr> <td>Length (cm)</td> <td>45</td> </tr> <tr> <td>Size</td> <td>6-0 (0.7 metric)</td> </tr> </tbody> </table> <table border="1"> <thead> <tr> <th colspan="2">Needle</th> </tr> </thead> <tbody> <tr> <td>Length (mm)</td> <td>6.5</td> </tr> <tr> <td>Curve</td> <td>1/4</td> </tr> <tr> <td>Diam. (mm)</td> <td>0.24</td> </tr> </tbody> </table>	Suture		Description	Polyglycolic Acid, Violet Braid	Length (cm)	45	Size	6-0 (0.7 metric)	Needle		Length (mm)	6.5	Curve	1/4	Diam. (mm)	0.24
Suture																			
Description	Polyglycolic Acid, Violet Braid																		
Length (cm)	45																		
Size	6-0 (0.7 metric)																		
Needle																			
Length (mm)	6.5																		
Curve	1/4																		
Diam. (mm)	0.24																		
AB-2890	<b>PGA Suture, Dia Spatula</b> Double-armed suture, measures 45cm in length. Dia spatula needle, measures 8.5mm in length, 1/4 curve, and 0.28mm in diameter. Manufactured by Mani.	 <p><b>Double-Armed Dia Spatula</b></p>	<table border="1"> <thead> <tr> <th colspan="2">Suture</th> </tr> </thead> <tbody> <tr> <td>Description</td> <td>Polyglycolic Acid, Violet Braid</td> </tr> <tr> <td>Length (cm)</td> <td>45</td> </tr> <tr> <td>Size</td> <td>6-0 (0.7 metric)</td> </tr> </tbody> </table> <table border="1"> <thead> <tr> <th colspan="2">Needle</th> </tr> </thead> <tbody> <tr> <td>Length (mm)</td> <td>8.5</td> </tr> <tr> <td>Curve</td> <td>1/4</td> </tr> <tr> <td>Diam. (mm)</td> <td>0.28</td> </tr> </tbody> </table>	Suture		Description	Polyglycolic Acid, Violet Braid	Length (cm)	45	Size	6-0 (0.7 metric)	Needle		Length (mm)	8.5	Curve	1/4	Diam. (mm)	0.28
Suture																			
Description	Polyglycolic Acid, Violet Braid																		
Length (cm)	45																		
Size	6-0 (0.7 metric)																		
Needle																			
Length (mm)	8.5																		
Curve	1/4																		
Diam. (mm)	0.28																		



POLYGLYCOLIC ACID

Item #	Description	Image	Suture	Needle												
AB-8117	<b>PGA Suture, Spatula</b> Double-armed suture, measures 45cm in length. Spatula needle, measures 8.0mm in length, 1/4 curve, and 0.70mm in diameter. Manufactured by Peters.	<b>Double-Armed Spatula</b> 	<table border="1"><tr><td>Description</td><td>Polyglycolic Acid, Violet Braid</td></tr><tr><td>Length (cm)</td><td>45</td></tr><tr><td>Size</td><td>6-0 (0.7 metric)</td></tr></table>	Description	Polyglycolic Acid, Violet Braid	Length (cm)	45	Size	6-0 (0.7 metric)	<table border="1"><tr><td>Length (mm)</td><td>8.0</td></tr><tr><td>Curve</td><td>1/4</td></tr><tr><td>Diam. (mm)</td><td>0.70</td></tr></table>	Length (mm)	8.0	Curve	1/4	Diam. (mm)	0.70
Description	Polyglycolic Acid, Violet Braid															
Length (cm)	45															
Size	6-0 (0.7 metric)															
Length (mm)	8.0															
Curve	1/4															
Diam. (mm)	0.70															
AB-8127	<b>PGA Suture, Spatula</b> Double-armed suture, measures 30cm in length. Spatula needle, measures 6.4mm in length, 1/2 curve, and 0.70mm in diameter. Manufactured by Peters.	<b>Double-Armed Spatula</b> 	<table border="1"><tr><td>Description</td><td>Polyglycolic Acid, Violet Braid</td></tr><tr><td>Length (cm)</td><td>30</td></tr><tr><td>Size</td><td>6-0 (0.7 metric)</td></tr></table>	Description	Polyglycolic Acid, Violet Braid	Length (cm)	30	Size	6-0 (0.7 metric)	<table border="1"><tr><td>Length (mm)</td><td>6.4</td></tr><tr><td>Curve</td><td>1/2</td></tr><tr><td>Diam. (mm)</td><td>0.70</td></tr></table>	Length (mm)	6.4	Curve	1/2	Diam. (mm)	0.70
Description	Polyglycolic Acid, Violet Braid															
Length (cm)	30															
Size	6-0 (0.7 metric)															
Length (mm)	6.4															
Curve	1/2															
Diam. (mm)	0.70															
AB-8138	<b>PGA Suture, Reverse Cut</b> Single-armed suture, measures 45cm in length. Reverse cut needle, measures 12.0mm in length, 3/8 curve, and 0.70mm in diameter. Manufactured by Peters.	<b>Single-Armed Reverse Cut</b> 	<table border="1"><tr><td>Description</td><td>Polyglycolic Acid, Violet Braid</td></tr><tr><td>Length (cm)</td><td>45</td></tr><tr><td>Size</td><td>6-0 (0.7 metric)</td></tr></table>	Description	Polyglycolic Acid, Violet Braid	Length (cm)	45	Size	6-0 (0.7 metric)	<table border="1"><tr><td>Length (mm)</td><td>12.0</td></tr><tr><td>Curve</td><td>3/8</td></tr><tr><td>Diam. (mm)</td><td>0.70</td></tr></table>	Length (mm)	12.0	Curve	3/8	Diam. (mm)	0.70
Description	Polyglycolic Acid, Violet Braid															
Length (cm)	45															
Size	6-0 (0.7 metric)															
Length (mm)	12.0															
Curve	3/8															
Diam. (mm)	0.70															
AXI4045	<b>PGA Suture, Reverse Cut</b> Double-armed suture, measures 45cm in length. Reverse cut needle, measures 8.0mm in length, 3/8 curve, and 0.70mm in diameter. Manufactured by Peters.	<b>Double-Armed Reverse Cut</b> 	<table border="1"><tr><td>Description</td><td>Polyglycolic Acid, Violet Braid</td></tr><tr><td>Length (cm)</td><td>45</td></tr><tr><td>Size</td><td>6-0 (0.7 metric)</td></tr></table>	Description	Polyglycolic Acid, Violet Braid	Length (cm)	45	Size	6-0 (0.7 metric)	<table border="1"><tr><td>Length (mm)</td><td>8.0</td></tr><tr><td>Curve</td><td>3/8</td></tr><tr><td>Diam. (mm)</td><td>0.70</td></tr></table>	Length (mm)	8.0	Curve	3/8	Diam. (mm)	0.70
Description	Polyglycolic Acid, Violet Braid															
Length (cm)	45															
Size	6-0 (0.7 metric)															
Length (mm)	8.0															
Curve	3/8															
Diam. (mm)	0.70															

Sutures 5-0 Polyglycolic Acid

Peters and Mani brand 5-0, violet braided, polyglycolic acid sutures with single and double arms. Dia spatula, spatula, and reverse cut needles ranging in length, curve, and diameter. Mani and Peters brand sutures are high-quality products with strong and break-resistant needles. Sold 12 per box.

AB-3391	<b>PGA Suture, Dia Spatula</b> Double-armed suture, measures 45cm in length. Dia spatula needle, measures 8.5mm in length, 1/4 curve, and 0.33mm in diameter. Manufactured by Mani.	<b>Double-Armed Dia Spatula</b> 	<table border="1"><tr><td>Description</td><td>Polyglycolic Acid, Violet Braid</td></tr><tr><td>Length (cm)</td><td>45</td></tr><tr><td>Size</td><td>5-0 (1.0 metric)</td></tr></table>	Description	Polyglycolic Acid, Violet Braid	Length (cm)	45	Size	5-0 (1.0 metric)	<table border="1"><tr><td>Length (mm)</td><td>8.5</td></tr><tr><td>Curve</td><td>1/4</td></tr><tr><td>Diam. (mm)</td><td>0.33</td></tr></table>	Length (mm)	8.5	Curve	1/4	Diam. (mm)	0.33
Description	Polyglycolic Acid, Violet Braid															
Length (cm)	45															
Size	5-0 (1.0 metric)															
Length (mm)	8.5															
Curve	1/4															
Diam. (mm)	0.33															
AB-8123	<b>PGA Suture, Spatula</b> Double-armed suture, measures 45cm in length. Spatula needle, measures 8.0mm in length, 1/4 curve, and 1.0mm in diameter. Manufactured by Peters.	<b>Double-Armed Spatula</b> 	<table border="1"><tr><td>Description</td><td>Polyglycolic Acid, Violet Braid</td></tr><tr><td>Length (cm)</td><td>45</td></tr><tr><td>Size</td><td>5-0 (1.0 metric)</td></tr></table>	Description	Polyglycolic Acid, Violet Braid	Length (cm)	45	Size	5-0 (1.0 metric)	<table border="1"><tr><td>Length (mm)</td><td>8.0</td></tr><tr><td>Curve</td><td>1/4</td></tr><tr><td>Diam. (mm)</td><td>1.0</td></tr></table>	Length (mm)	8.0	Curve	1/4	Diam. (mm)	1.0
Description	Polyglycolic Acid, Violet Braid															
Length (cm)	45															
Size	5-0 (1.0 metric)															
Length (mm)	8.0															
Curve	1/4															
Diam. (mm)	1.0															
AXI4046	<b>PGA Suture, Reverse Cut</b> Single-armed suture, measures 45cm in length. Reverse cut needle, measures 16.0mm in length, 1/2 curve, and 1.0mm in diameter. Manufactured by Peters.	<b>Single-Armed Reverse Cut</b> 	<table border="1"><tr><td>Description</td><td>Polyglycolic Acid, Violet Braid</td></tr><tr><td>Length (cm)</td><td>45</td></tr><tr><td>Size</td><td>5-0 (1.0 metric)</td></tr></table>	Description	Polyglycolic Acid, Violet Braid	Length (cm)	45	Size	5-0 (1.0 metric)	<table border="1"><tr><td>Length (mm)</td><td>16.0</td></tr><tr><td>Curve</td><td>1/2</td></tr><tr><td>Diam. (mm)</td><td>1.0</td></tr></table>	Length (mm)	16.0	Curve	1/2	Diam. (mm)	1.0
Description	Polyglycolic Acid, Violet Braid															
Length (cm)	45															
Size	5-0 (1.0 metric)															
Length (mm)	16.0															
Curve	1/2															
Diam. (mm)	1.0															

POLYPROPYLENE

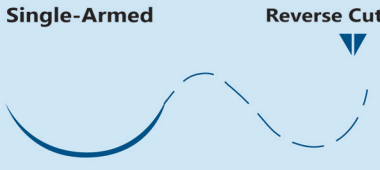
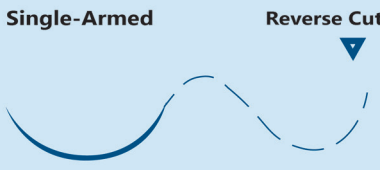
Item #	Description	Image																
<b>Sutures 6-0 Polypropylene</b>																		
Ethicon and Surgical Specialties brand 6-0, blue polypropylene sutures with single arms. Reverse cut needles ranging in length and curve. Sold 12 per box.																		
AB-8697G	<p><b>Prolene Suture, Reverse Cut</b></p> <p>Single-armed suture, measures 45cm in length. Reverse cut needle, measures 11.0mm in length, and 3/8 curve. Manufactured by Ethicon.</p>	 <table border="1"> <thead> <tr> <th colspan="2">Suture</th> </tr> </thead> <tbody> <tr> <td>Description</td> <td>Polypropylene, Blue Mono</td> </tr> <tr> <td>Length (cm)</td> <td>45</td> </tr> <tr> <td>Size</td> <td>6-0 (0.7 metric)</td> </tr> </tbody> </table> <table border="1"> <thead> <tr> <th colspan="2">Needle</th> </tr> </thead> <tbody> <tr> <td>Length (mm)</td> <td>11.0</td> </tr> <tr> <td>Curve</td> <td>3/8</td> </tr> <tr> <td>Diam. (mm)</td> <td></td> </tr> </tbody> </table>	Suture		Description	Polypropylene, Blue Mono	Length (cm)	45	Size	6-0 (0.7 metric)	Needle		Length (mm)	11.0	Curve	3/8	Diam. (mm)	
Suture																		
Description	Polypropylene, Blue Mono																	
Length (cm)	45																	
Size	6-0 (0.7 metric)																	
Needle																		
Length (mm)	11.0																	
Curve	3/8																	
Diam. (mm)																		
AXI3144	<p><b>Prolene Suture, Reverse Cut</b></p> <p>Single-armed suture, measures 45cm in length. Reverse cut needle, measures 11.0mm in length, and 3/8 curve. Manufactured by Surgical Specialties.</p>	 <table border="1"> <thead> <tr> <th colspan="2">Suture</th> </tr> </thead> <tbody> <tr> <td>Description</td> <td>Polypropylene, Blue Mono</td> </tr> <tr> <td>Length (cm)</td> <td>45</td> </tr> <tr> <td>Size</td> <td>6-0 (0.7 metric)</td> </tr> </tbody> </table> <table border="1"> <thead> <tr> <th colspan="2">Needle</th> </tr> </thead> <tbody> <tr> <td>Length (mm)</td> <td>11.0</td> </tr> <tr> <td>Curve</td> <td>3/8</td> </tr> <tr> <td>Diam. (mm)</td> <td></td> </tr> </tbody> </table>	Suture		Description	Polypropylene, Blue Mono	Length (cm)	45	Size	6-0 (0.7 metric)	Needle		Length (mm)	11.0	Curve	3/8	Diam. (mm)	
Suture																		
Description	Polypropylene, Blue Mono																	
Length (cm)	45																	
Size	6-0 (0.7 metric)																	
Needle																		
Length (mm)	11.0																	
Curve	3/8																	
Diam. (mm)																		

SILK

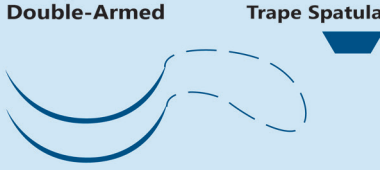
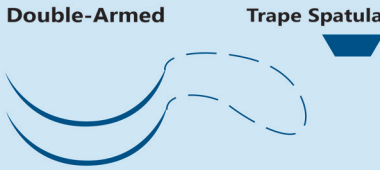
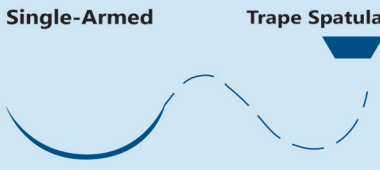
Item #	Description	Image																
<b>Sutures 8-0 Silk</b>																		
Mani brand 8-0, black braided, silk sutures with both single and double arms. Trape spatula needles ranging in length, curve, and diameter. Mani sutures are ideal for micro-suturing on the cornea and sclera during eye surgery. Ultimate sharpness is obtained through the "cross-lapped edge" technique giving each suture a fine and sharp tip ensuring minimally invasive wound closure. Mani hard fiber stainless steel is used to make strong and break-resistant needles. Sold 12 per box.																		
AB-1467	<p><b>Silk Suture, Trape Spatula</b></p> <p>Double-armed suture, measures 45cm in length. Trape spatula needle, measures 6.0mm in length, 3/8 curve, and 0.18mm in diameter.</p>	 <table border="1"> <thead> <tr> <th colspan="2">Suture</th> </tr> </thead> <tbody> <tr> <td>Description</td> <td>Silk, Black Braided</td> </tr> <tr> <td>Length (cm)</td> <td>45</td> </tr> <tr> <td>Size</td> <td>8-0 (0.4 metric)</td> </tr> </tbody> </table> <table border="1"> <thead> <tr> <th colspan="2">Needle</th> </tr> </thead> <tbody> <tr> <td>Length (mm)</td> <td>6.0</td> </tr> <tr> <td>Curve</td> <td>3/8</td> </tr> <tr> <td>Diam. (mm)</td> <td>0.18</td> </tr> </tbody> </table>	Suture		Description	Silk, Black Braided	Length (cm)	45	Size	8-0 (0.4 metric)	Needle		Length (mm)	6.0	Curve	3/8	Diam. (mm)	0.18
Suture																		
Description	Silk, Black Braided																	
Length (cm)	45																	
Size	8-0 (0.4 metric)																	
Needle																		
Length (mm)	6.0																	
Curve	3/8																	
Diam. (mm)	0.18																	
AB-2023	<p><b>Silk Suture, Trape Spatula</b></p> <p>Double-armed suture, measures 45cm in length. Trape spatula needle, measures 6.5mm in length, 3/8 curve, and 0.20mm in diameter.</p>	 <table border="1"> <thead> <tr> <th colspan="2">Suture</th> </tr> </thead> <tbody> <tr> <td>Description</td> <td>Silk, Black Braided</td> </tr> <tr> <td>Length (cm)</td> <td>45</td> </tr> <tr> <td>Size</td> <td>8-0 (0.4 metric)</td> </tr> </tbody> </table> <table border="1"> <thead> <tr> <th colspan="2">Needle</th> </tr> </thead> <tbody> <tr> <td>Length (mm)</td> <td>6.5</td> </tr> <tr> <td>Curve</td> <td>3/8</td> </tr> <tr> <td>Diam. (mm)</td> <td>0.20</td> </tr> </tbody> </table>	Suture		Description	Silk, Black Braided	Length (cm)	45	Size	8-0 (0.4 metric)	Needle		Length (mm)	6.5	Curve	3/8	Diam. (mm)	0.20
Suture																		
Description	Silk, Black Braided																	
Length (cm)	45																	
Size	8-0 (0.4 metric)																	
Needle																		
Length (mm)	6.5																	
Curve	3/8																	
Diam. (mm)	0.20																	
AB-2023S	<p><b>Silk Suture, Trape Spatula</b></p> <p>Single-armed suture, measures 20cm in length. Trape spatula needle, measures 6.5mm in length, 3/8 curve, and 0.20mm in diameter.</p>	 <table border="1"> <thead> <tr> <th colspan="2">Suture</th> </tr> </thead> <tbody> <tr> <td>Description</td> <td>Silk, Black Braided</td> </tr> <tr> <td>Length (cm)</td> <td>20</td> </tr> <tr> <td>Size</td> <td>8-0 (0.4 metric)</td> </tr> </tbody> </table> <table border="1"> <thead> <tr> <th colspan="2">Needle</th> </tr> </thead> <tbody> <tr> <td>Length (mm)</td> <td>6.5</td> </tr> <tr> <td>Curve</td> <td>3/8</td> </tr> <tr> <td>Diam. (mm)</td> <td>0.20</td> </tr> </tbody> </table>	Suture		Description	Silk, Black Braided	Length (cm)	20	Size	8-0 (0.4 metric)	Needle		Length (mm)	6.5	Curve	3/8	Diam. (mm)	0.20
Suture																		
Description	Silk, Black Braided																	
Length (cm)	20																	
Size	8-0 (0.4 metric)																	
Needle																		
Length (mm)	6.5																	
Curve	3/8																	
Diam. (mm)	0.20																	

SILK

Item #	Description	Image
--------	-------------	-------

Sutures 7-0 Silk

Mani brand 7-0, black or white braided, silk sutures with both single and double arms. Trape spatula and lancet needles ranging in length, curve, and diameter. Mani sutures are ideal for micro-suturing on the cornea and sclera during eye surgery. Ultimate sharpness is obtained through the "cross-lapped edge" technique giving each suture a fine and sharp tip ensuring minimally invasive wound closure. Mani hard fiber stainless steel is used to make strong and break-resistant needles. Sold 12 per box.

AB-2008	<p><b>Silk Suture, Trape Spatula</b></p> <p>Black braided, double-armed suture, measures 45cm in length. Trape spatula needle, measures 6.5mm in length, 3/8 curve, and 0.20mm in diameter.</p>	<p><b>Double-Armed Trape Spatula</b></p>	<table border="1"> <thead> <tr> <th colspan="2">Suture</th> </tr> </thead> <tbody> <tr> <td>Description</td> <td>Silk, Black Braided</td> </tr> <tr> <td>Length (cm)</td> <td>45</td> </tr> <tr> <td>Size</td> <td>7-0 (0.5 metric)</td> </tr> </tbody> </table> <table border="1"> <thead> <tr> <th colspan="2">Needle</th> </tr> </thead> <tbody> <tr> <td>Length (mm)</td> <td>6.5</td> </tr> <tr> <td>Curve</td> <td>3/8</td> </tr> <tr> <td>Diam. (mm)</td> <td>0.20</td> </tr> </tbody> </table>	Suture		Description	Silk, Black Braided	Length (cm)	45	Size	7-0 (0.5 metric)	Needle		Length (mm)	6.5	Curve	3/8	Diam. (mm)	0.20
Suture																			
Description	Silk, Black Braided																		
Length (cm)	45																		
Size	7-0 (0.5 metric)																		
Needle																			
Length (mm)	6.5																		
Curve	3/8																		
Diam. (mm)	0.20																		
AB-2008S	<p><b>Silk Suture, Trape Spatula</b></p> <p>Black braided, single-armed suture, measures 30cm in length. Trape spatula needle, measures 6.5mm in length, 3/8 curve, and 0.20mm in diameter.</p>	<p><b>Single-Armed Trape Spatula</b></p>	<table border="1"> <thead> <tr> <th colspan="2">Suture</th> </tr> </thead> <tbody> <tr> <td>Description</td> <td>Silk, Black Braided</td> </tr> <tr> <td>Length (cm)</td> <td>30</td> </tr> <tr> <td>Size</td> <td>7-0 (0.5 metric)</td> </tr> </tbody> </table> <table border="1"> <thead> <tr> <th colspan="2">Needle</th> </tr> </thead> <tbody> <tr> <td>Length (mm)</td> <td>6.5</td> </tr> <tr> <td>Curve</td> <td>3/8</td> </tr> <tr> <td>Diam. (mm)</td> <td>0.20</td> </tr> </tbody> </table>	Suture		Description	Silk, Black Braided	Length (cm)	30	Size	7-0 (0.5 metric)	Needle		Length (mm)	6.5	Curve	3/8	Diam. (mm)	0.20
Suture																			
Description	Silk, Black Braided																		
Length (cm)	30																		
Size	7-0 (0.5 metric)																		
Needle																			
Length (mm)	6.5																		
Curve	3/8																		
Diam. (mm)	0.20																		
AB-2063	<p><b>Silk Suture, Trape Spatula</b></p> <p>Black braided, double-armed suture, measures 30cm in length. Trape spatula needle, measures 6.5mm in length, 3/8 curve, and 0.20mm in diameter.</p>	<p><b>Double-Armed Trape Spatula</b></p>	<table border="1"> <thead> <tr> <th colspan="2">Suture</th> </tr> </thead> <tbody> <tr> <td>Description</td> <td>Silk, Black Braided</td> </tr> <tr> <td>Length (cm)</td> <td>30</td> </tr> <tr> <td>Size</td> <td>7-0 (0.5 metric)</td> </tr> </tbody> </table> <table border="1"> <thead> <tr> <th colspan="2">Needle</th> </tr> </thead> <tbody> <tr> <td>Length (mm)</td> <td>6.5</td> </tr> <tr> <td>Curve</td> <td>3/8</td> </tr> <tr> <td>Diam. (mm)</td> <td>0.20</td> </tr> </tbody> </table>	Suture		Description	Silk, Black Braided	Length (cm)	30	Size	7-0 (0.5 metric)	Needle		Length (mm)	6.5	Curve	3/8	Diam. (mm)	0.20
Suture																			
Description	Silk, Black Braided																		
Length (cm)	30																		
Size	7-0 (0.5 metric)																		
Needle																			
Length (mm)	6.5																		
Curve	3/8																		
Diam. (mm)	0.20																		
AB-2062S	<p><b>Silk Suture, Trape Spatula</b></p> <p>Black braided, single-armed suture, measures 45cm in length. Trape spatula needle, measures 8.0mm in length, 1/2 curve, and 0.20mm in diameter.</p>	<p><b>Single-Armed Trape Spatula</b></p>	<table border="1"> <thead> <tr> <th colspan="2">Suture</th> </tr> </thead> <tbody> <tr> <td>Description</td> <td>Silk, Black Braided</td> </tr> <tr> <td>Length (cm)</td> <td>45</td> </tr> <tr> <td>Size</td> <td>7-0 (0.5 metric)</td> </tr> </tbody> </table> <table border="1"> <thead> <tr> <th colspan="2">Needle</th> </tr> </thead> <tbody> <tr> <td>Length (mm)</td> <td>8.0</td> </tr> <tr> <td>Curve</td> <td>1/2</td> </tr> <tr> <td>Diam. (mm)</td> <td>0.20</td> </tr> </tbody> </table>	Suture		Description	Silk, Black Braided	Length (cm)	45	Size	7-0 (0.5 metric)	Needle		Length (mm)	8.0	Curve	1/2	Diam. (mm)	0.20
Suture																			
Description	Silk, Black Braided																		
Length (cm)	45																		
Size	7-0 (0.5 metric)																		
Needle																			
Length (mm)	8.0																		
Curve	1/2																		
Diam. (mm)	0.20																		
AB-2068S	<p><b>Silk Suture, Trape Spatula</b></p> <p>White braided, single-armed suture, measures 45cm in length. Trape spatula needle, measures 8.0mm in length, 1/2 curve, and 0.20mm in diameter.</p>	<p><b>Single-Armed Trape Spatula</b></p>	<table border="1"> <thead> <tr> <th colspan="2">Suture</th> </tr> </thead> <tbody> <tr> <td>Description</td> <td>Silk, White Braided</td> </tr> <tr> <td>Length (cm)</td> <td>45</td> </tr> <tr> <td>Size</td> <td>7-0 (0.5 metric)</td> </tr> </tbody> </table> <table border="1"> <thead> <tr> <th colspan="2">Needle</th> </tr> </thead> <tbody> <tr> <td>Length (mm)</td> <td>8.0</td> </tr> <tr> <td>Curve</td> <td>1/2</td> </tr> <tr> <td>Diam. (mm)</td> <td>0.20</td> </tr> </tbody> </table>	Suture		Description	Silk, White Braided	Length (cm)	45	Size	7-0 (0.5 metric)	Needle		Length (mm)	8.0	Curve	1/2	Diam. (mm)	0.20
Suture																			
Description	Silk, White Braided																		
Length (cm)	45																		
Size	7-0 (0.5 metric)																		
Needle																			
Length (mm)	8.0																		
Curve	1/2																		
Diam. (mm)	0.20																		
AB-2860S	<p><b>Silk Suture, Lancet</b></p> <p>Black braided, single-armed suture, measures 50cm in length. Lancet needle, measures 7.0mm in length, 3/8 curve, and 0.28mm in diameter.</p>	<p><b>Single-Armed Lancet</b></p>	<table border="1"> <thead> <tr> <th colspan="2">Suture</th> </tr> </thead> <tbody> <tr> <td>Description</td> <td>Silk, Black Braided</td> </tr> <tr> <td>Length (cm)</td> <td>50</td> </tr> <tr> <td>Size</td> <td>7-0 (0.5 metric)</td> </tr> </tbody> </table> <table border="1"> <thead> <tr> <th colspan="2">Needle</th> </tr> </thead> <tbody> <tr> <td>Length (mm)</td> <td>7.0</td> </tr> <tr> <td>Curve</td> <td>3/8</td> </tr> <tr> <td>Diam. (mm)</td> <td>0.28</td> </tr> </tbody> </table>	Suture		Description	Silk, Black Braided	Length (cm)	50	Size	7-0 (0.5 metric)	Needle		Length (mm)	7.0	Curve	3/8	Diam. (mm)	0.28
Suture																			
Description	Silk, Black Braided																		
Length (cm)	50																		
Size	7-0 (0.5 metric)																		
Needle																			
Length (mm)	7.0																		
Curve	3/8																		
Diam. (mm)	0.28																		

SILK

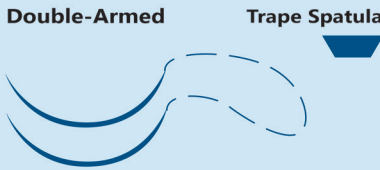
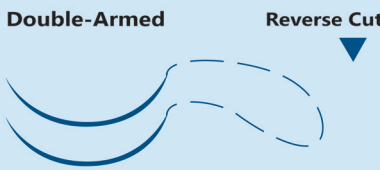
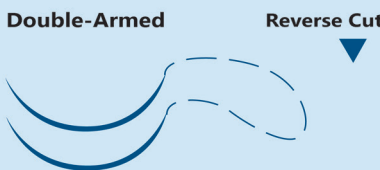
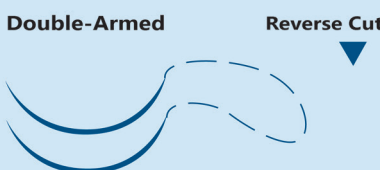
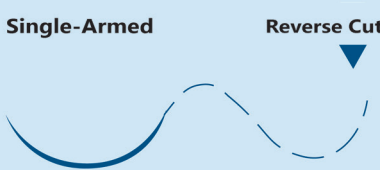
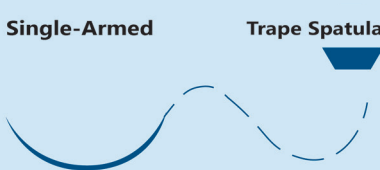
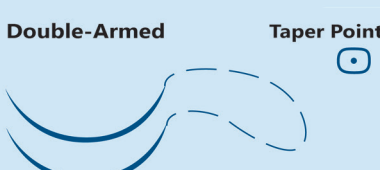
Item #	Description	Image																
<b>Sutures 6-0 Silk</b>																		
AB-2801	<p><b>Silk Suture, Trape Spatula</b></p> <p>Double-armed suture, measures 45cm in length. Trape spatula needle, measures 6.5mm in length, 3/8 curve, and 0.28mm in diameter.</p>	 <table border="1"> <thead> <tr> <th colspan="2">Suture</th> </tr> </thead> <tbody> <tr> <td>Description</td> <td>Silk, Black Braided</td> </tr> <tr> <td>Length (cm)</td> <td>45</td> </tr> <tr> <td>Size</td> <td>6-0 (0.7 metric)</td> </tr> </tbody> </table> <table border="1"> <thead> <tr> <th colspan="2">Needle</th> </tr> </thead> <tbody> <tr> <td>Length (mm)</td> <td>6.5</td> </tr> <tr> <td>Curve</td> <td>3/8</td> </tr> <tr> <td>Diam. (mm)</td> <td>0.28</td> </tr> </tbody> </table>	Suture		Description	Silk, Black Braided	Length (cm)	45	Size	6-0 (0.7 metric)	Needle		Length (mm)	6.5	Curve	3/8	Diam. (mm)	0.28
Suture																		
Description	Silk, Black Braided																	
Length (cm)	45																	
Size	6-0 (0.7 metric)																	
Needle																		
Length (mm)	6.5																	
Curve	3/8																	
Diam. (mm)	0.28																	
AB-2805	<p><b>Silk Suture, Reverse Cut</b></p> <p>Double-armed suture, measures 45cm in length. Reverse cut needle, measures 8.0mm in length, 5/16 curve, and 0.28mm in diameter.</p>	 <table border="1"> <thead> <tr> <th colspan="2">Suture</th> </tr> </thead> <tbody> <tr> <td>Description</td> <td>Silk, Black Braided</td> </tr> <tr> <td>Length (cm)</td> <td>45</td> </tr> <tr> <td>Size</td> <td>6-0 (0.7 metric)</td> </tr> </tbody> </table> <table border="1"> <thead> <tr> <th colspan="2">Needle</th> </tr> </thead> <tbody> <tr> <td>Length (mm)</td> <td>8.0</td> </tr> <tr> <td>Curve</td> <td>5/16</td> </tr> <tr> <td>Diam. (mm)</td> <td>0.28</td> </tr> </tbody> </table>	Suture		Description	Silk, Black Braided	Length (cm)	45	Size	6-0 (0.7 metric)	Needle		Length (mm)	8.0	Curve	5/16	Diam. (mm)	0.28
Suture																		
Description	Silk, Black Braided																	
Length (cm)	45																	
Size	6-0 (0.7 metric)																	
Needle																		
Length (mm)	8.0																	
Curve	5/16																	
Diam. (mm)	0.28																	
AB-2853	<p><b>Silk Suture, Reverse Cut</b></p> <p>Double-armed suture, measures 45cm in length. Reverse cut needle, measures 7.0mm in length, 3/8 curve, and 0.28mm in diameter.</p>	 <table border="1"> <thead> <tr> <th colspan="2">Suture</th> </tr> </thead> <tbody> <tr> <td>Description</td> <td>Silk, Black Braided</td> </tr> <tr> <td>Length (cm)</td> <td>45</td> </tr> <tr> <td>Size</td> <td>6-0 (0.7 metric)</td> </tr> </tbody> </table> <table border="1"> <thead> <tr> <th colspan="2">Needle</th> </tr> </thead> <tbody> <tr> <td>Length (mm)</td> <td>7.0</td> </tr> <tr> <td>Curve</td> <td>3/8</td> </tr> <tr> <td>Diam. (mm)</td> <td>0.28</td> </tr> </tbody> </table>	Suture		Description	Silk, Black Braided	Length (cm)	45	Size	6-0 (0.7 metric)	Needle		Length (mm)	7.0	Curve	3/8	Diam. (mm)	0.28
Suture																		
Description	Silk, Black Braided																	
Length (cm)	45																	
Size	6-0 (0.7 metric)																	
Needle																		
Length (mm)	7.0																	
Curve	3/8																	
Diam. (mm)	0.28																	
AB-3305	<p><b>Silk Suture, Reverse Cut</b></p> <p>Double-armed suture, measures 45cm in length. Reverse cut needle, measures 11.0mm in length, 3/8 curve, and 0.33mm in diameter.</p>	 <table border="1"> <thead> <tr> <th colspan="2">Suture</th> </tr> </thead> <tbody> <tr> <td>Description</td> <td>Silk, Black Braided</td> </tr> <tr> <td>Length (cm)</td> <td>45</td> </tr> <tr> <td>Size</td> <td>6-0 (0.7 metric)</td> </tr> </tbody> </table> <table border="1"> <thead> <tr> <th colspan="2">Needle</th> </tr> </thead> <tbody> <tr> <td>Length (mm)</td> <td>11.0</td> </tr> <tr> <td>Curve</td> <td>3/8</td> </tr> <tr> <td>Diam. (mm)</td> <td>0.33</td> </tr> </tbody> </table>	Suture		Description	Silk, Black Braided	Length (cm)	45	Size	6-0 (0.7 metric)	Needle		Length (mm)	11.0	Curve	3/8	Diam. (mm)	0.33
Suture																		
Description	Silk, Black Braided																	
Length (cm)	45																	
Size	6-0 (0.7 metric)																	
Needle																		
Length (mm)	11.0																	
Curve	3/8																	
Diam. (mm)	0.33																	
AB-3305S	<p><b>Silk Suture, Reverse Cut</b></p> <p>Single-armed suture, measures 45cm in length. Reverse cut needle, measures 11.0mm in length, 3/8 curve, and 0.33mm in diameter.</p>	 <table border="1"> <thead> <tr> <th colspan="2">Suture</th> </tr> </thead> <tbody> <tr> <td>Description</td> <td>Silk, Black Braided</td> </tr> <tr> <td>Length (cm)</td> <td>45</td> </tr> <tr> <td>Size</td> <td>6-0 (0.7 metric)</td> </tr> </tbody> </table> <table border="1"> <thead> <tr> <th colspan="2">Needle</th> </tr> </thead> <tbody> <tr> <td>Length (mm)</td> <td>11.0</td> </tr> <tr> <td>Curve</td> <td>3/8</td> </tr> <tr> <td>Diam. (mm)</td> <td>0.33</td> </tr> </tbody> </table>	Suture		Description	Silk, Black Braided	Length (cm)	45	Size	6-0 (0.7 metric)	Needle		Length (mm)	11.0	Curve	3/8	Diam. (mm)	0.33
Suture																		
Description	Silk, Black Braided																	
Length (cm)	45																	
Size	6-0 (0.7 metric)																	
Needle																		
Length (mm)	11.0																	
Curve	3/8																	
Diam. (mm)	0.33																	
AB-3354S	<p><b>Silk Suture, Trape Spatula</b></p> <p>Single-armed suture, measures 50cm in length. Trape spatula needle, measures 10.0mm in length, 3/8 curve, and 0.33mm in diameter.</p>	 <table border="1"> <thead> <tr> <th colspan="2">Suture</th> </tr> </thead> <tbody> <tr> <td>Description</td> <td>Silk, Black Braided</td> </tr> <tr> <td>Length (cm)</td> <td>50</td> </tr> <tr> <td>Size</td> <td>6-0 (0.7 metric)</td> </tr> </tbody> </table> <table border="1"> <thead> <tr> <th colspan="2">Needle</th> </tr> </thead> <tbody> <tr> <td>Length (mm)</td> <td>10.0</td> </tr> <tr> <td>Curve</td> <td>3/8</td> </tr> <tr> <td>Diam. (mm)</td> <td>0.33</td> </tr> </tbody> </table>	Suture		Description	Silk, Black Braided	Length (cm)	50	Size	6-0 (0.7 metric)	Needle		Length (mm)	10.0	Curve	3/8	Diam. (mm)	0.33
Suture																		
Description	Silk, Black Braided																	
Length (cm)	50																	
Size	6-0 (0.7 metric)																	
Needle																		
Length (mm)	10.0																	
Curve	3/8																	
Diam. (mm)	0.33																	
AB-3356	<p><b>Silk Suture, Taper Point</b></p> <p>Double-armed suture, measures 55cm in length. Taper point needle, measures 13.0mm in length, 3/8 curve, and 0.33mm in diameter.</p>	 <table border="1"> <thead> <tr> <th colspan="2">Suture</th> </tr> </thead> <tbody> <tr> <td>Description</td> <td>Silk, Black Braided</td> </tr> <tr> <td>Length (cm)</td> <td>55</td> </tr> <tr> <td>Size</td> <td>6-0 (0.7 metric)</td> </tr> </tbody> </table> <table border="1"> <thead> <tr> <th colspan="2">Needle</th> </tr> </thead> <tbody> <tr> <td>Length (mm)</td> <td>13.0</td> </tr> <tr> <td>Curve</td> <td>3/8</td> </tr> <tr> <td>Diam. (mm)</td> <td>0.33</td> </tr> </tbody> </table>	Suture		Description	Silk, Black Braided	Length (cm)	55	Size	6-0 (0.7 metric)	Needle		Length (mm)	13.0	Curve	3/8	Diam. (mm)	0.33
Suture																		
Description	Silk, Black Braided																	
Length (cm)	55																	
Size	6-0 (0.7 metric)																	
Needle																		
Length (mm)	13.0																	
Curve	3/8																	
Diam. (mm)	0.33																	

SILK

Item #	Description	Image	Suture	Needle												
AB-3366	<b>Silk Suture, Lancet</b> Double-armed suture, measures 55cm in length. Lancet needle, measures 10.0mm in length, 3/8 curve, and 0.33mm in diameter.	<b>Double-Armed Lancet</b> 	<table border="1"><tr><td>Description</td><td>Silk, Black Braided</td></tr><tr><td>Length (cm)</td><td>55</td></tr><tr><td>Size</td><td>6-0 (0.7 metric)</td></tr></table>	Description	Silk, Black Braided	Length (cm)	55	Size	6-0 (0.7 metric)	<table border="1"><tr><td>Length (mm)</td><td>10.0</td></tr><tr><td>Curve</td><td>3/8</td></tr><tr><td>Diam. (mm)</td><td>0.33</td></tr></table>	Length (mm)	10.0	Curve	3/8	Diam. (mm)	0.33
Description	Silk, Black Braided															
Length (cm)	55															
Size	6-0 (0.7 metric)															
Length (mm)	10.0															
Curve	3/8															
Diam. (mm)	0.33															
AB-2804	<b>Silk Suture, Trape Spatula</b> Double-armed suture, measures 45cm in length. Trape spatula needle, measures 5.5mm in length, 7/16 curve, and 0.28mm in diameter.	<b>Double-Armed Trape Spatula</b> 	<table border="1"><tr><td>Description</td><td>Silk, Black Braided</td></tr><tr><td>Length (cm)</td><td>45</td></tr><tr><td>Size</td><td>6-0 (0.7 metric)</td></tr></table>	Description	Silk, Black Braided	Length (cm)	45	Size	6-0 (0.7 metric)	<table border="1"><tr><td>Length (mm)</td><td>5.5</td></tr><tr><td>Curve</td><td>7/16</td></tr><tr><td>Diam. (mm)</td><td>0.28</td></tr></table>	Length (mm)	5.5	Curve	7/16	Diam. (mm)	0.28
Description	Silk, Black Braided															
Length (cm)	45															
Size	6-0 (0.7 metric)															
Length (mm)	5.5															
Curve	7/16															
Diam. (mm)	0.28															
AB-3353	<b>Silk Suture, Cut Taper</b> Double-armed suture, measures 55cm in length. Cut taper needle, measures 13.0mm in length, 3/8 curve, and 0.33mm in diameter.	<b>Double-Armed Cut Taper</b> 	<table border="1"><tr><td>Description</td><td>Silk, Black Braided</td></tr><tr><td>Length (cm)</td><td>55</td></tr><tr><td>Size</td><td>6-0 (0.7 metric)</td></tr></table>	Description	Silk, Black Braided	Length (cm)	55	Size	6-0 (0.7 metric)	<table border="1"><tr><td>Length (mm)</td><td>13.0</td></tr><tr><td>Curve</td><td>3/8</td></tr><tr><td>Diam. (mm)</td><td>0.33</td></tr></table>	Length (mm)	13.0	Curve	3/8	Diam. (mm)	0.33
Description	Silk, Black Braided															
Length (cm)	55															
Size	6-0 (0.7 metric)															
Length (mm)	13.0															
Curve	3/8															
Diam. (mm)	0.33															
AB-3850S	<b>Silk Suture, Cut Taper</b> Single-armed suture, measures 60cm in length. Cut taper needle, measures 14.0mm in length, 3/8 curve, and 0.38mm in diameter.	<b>Single-Armed Cut Taper</b> 	<table border="1"><tr><td>Description</td><td>Silk, Black Braided</td></tr><tr><td>Length (cm)</td><td>60</td></tr><tr><td>Size</td><td>6-0 (0.7 metric)</td></tr></table>	Description	Silk, Black Braided	Length (cm)	60	Size	6-0 (0.7 metric)	<table border="1"><tr><td>Length (mm)</td><td>14.0</td></tr><tr><td>Curve</td><td>3/8</td></tr><tr><td>Diam. (mm)</td><td>0.38</td></tr></table>	Length (mm)	14.0	Curve	3/8	Diam. (mm)	0.38
Description	Silk, Black Braided															
Length (cm)	60															
Size	6-0 (0.7 metric)															
Length (mm)	14.0															
Curve	3/8															
Diam. (mm)	0.38															

Sutures 5-0 Silk

Mani brand 5-0, black braided, silk sutures with both single and double arms. Lancet, reverse cut, and taper point needles ranging in length, curve, and diameter. Mani sutures are ideal for micro-suturing on the cornea and sclera during eye surgery. Ultimate sharpness is obtained through the "cross-lapped edge" technique giving each suture a fine and sharp tip ensuring minimally invasive wound closure. Mani hard fiber stainless steel is used to make strong and break-resistant needles. Sold 12 per box.

AB-3355	<b>Silk Suture, Taper Point</b> Double-armed suture, measures 45cm in length. Taper point needle, measures 13.0mm in length, 3/8 curve, and 0.33mm in diameter.	<b>Double-Armed Taper Point</b> 	<table border="1"><tr><td>Description</td><td>Silk, Black Braided</td></tr><tr><td>Length (cm)</td><td>45</td></tr><tr><td>Size</td><td>5-0 (1.0 metric)</td></tr></table>	Description	Silk, Black Braided	Length (cm)	45	Size	5-0 (1.0 metric)	<table border="1"><tr><td>Length (mm)</td><td>13.0</td></tr><tr><td>Curve</td><td>3/8</td></tr><tr><td>Diam. (mm)</td><td>0.33</td></tr></table>	Length (mm)	13.0	Curve	3/8	Diam. (mm)	0.33
Description	Silk, Black Braided															
Length (cm)	45															
Size	5-0 (1.0 metric)															
Length (mm)	13.0															
Curve	3/8															
Diam. (mm)	0.33															
AB-3355S	<b>Silk Suture, Taper Point</b> Single-armed suture, measures 30cm in length. Taper point needle, measures 13.0mm in length, 3/8 curve, and 0.33mm in diameter.	<b>Single-Armed Taper Point</b> 	<table border="1"><tr><td>Description</td><td>Silk, Black Braided</td></tr><tr><td>Length (cm)</td><td>30</td></tr><tr><td>Size</td><td>5-0 (1.0 metric)</td></tr></table>	Description	Silk, Black Braided	Length (cm)	30	Size	5-0 (1.0 metric)	<table border="1"><tr><td>Length (mm)</td><td>13.0</td></tr><tr><td>Curve</td><td>3/8</td></tr><tr><td>Diam. (mm)</td><td>0.33</td></tr></table>	Length (mm)	13.0	Curve	3/8	Diam. (mm)	0.33
Description	Silk, Black Braided															
Length (cm)	30															
Size	5-0 (1.0 metric)															
Length (mm)	13.0															
Curve	3/8															
Diam. (mm)	0.33															
AB-3358S	<b>Silk Suture, Reverse Cut</b> Single-armed suture, measures 50cm in length. Reverse cut needle, measures 13.0mm in length, 3/8 curve, and 0.33mm in diameter.	<b>Single-Armed Reverse Cut</b> 	<table border="1"><tr><td>Description</td><td>Silk, Black Braided</td></tr><tr><td>Length (cm)</td><td>50</td></tr><tr><td>Size</td><td>5-0 (1.0 metric)</td></tr></table>	Description	Silk, Black Braided	Length (cm)	50	Size	5-0 (1.0 metric)	<table border="1"><tr><td>Length (mm)</td><td>13.0</td></tr><tr><td>Curve</td><td>3/8</td></tr><tr><td>Diam. (mm)</td><td>0.33</td></tr></table>	Length (mm)	13.0	Curve	3/8	Diam. (mm)	0.33
Description	Silk, Black Braided															
Length (cm)	50															
Size	5-0 (1.0 metric)															
Length (mm)	13.0															
Curve	3/8															
Diam. (mm)	0.33															



SILK

Item #	Description	Image	Suture																
AB-3855S	<b>Silk Suture, Taper Point</b> Single-armed suture, measures 30cm in length. Taper point needle, measures 16.0mm in length, 3/8 curve, and 0.38mm in diameter.	<b>Single-Armed Taper Point</b> 	<table border="1"> <tr><th colspan="2">Suture</th></tr> <tr><td>Description</td><td>Silk, Black Braided</td></tr> <tr><td>Length (cm)</td><td>30</td></tr> <tr><td>Size</td><td>5-0 (1.0 metric)</td></tr> </table> <table border="1"> <tr><th colspan="2">Needle</th></tr> <tr><td>Length (mm)</td><td>16.0</td></tr> <tr><td>Curve</td><td>3/8</td></tr> <tr><td>Diam. (mm)</td><td>0.38</td></tr> </table>	Suture		Description	Silk, Black Braided	Length (cm)	30	Size	5-0 (1.0 metric)	Needle		Length (mm)	16.0	Curve	3/8	Diam. (mm)	0.38
Suture																			
Description	Silk, Black Braided																		
Length (cm)	30																		
Size	5-0 (1.0 metric)																		
Needle																			
Length (mm)	16.0																		
Curve	3/8																		
Diam. (mm)	0.38																		
AB-4350S	<b>Silk Suture, Reverse Cut</b> Single-armed suture, measures 50cm in length. Reverse cut needle, measures 11.0mm in length, 3/8 curve, and 0.43mm in diameter.	<b>Single-Armed Reverse Cut</b> 	<table border="1"> <tr><th colspan="2">Suture</th></tr> <tr><td>Description</td><td>Silk, Black Braided</td></tr> <tr><td>Length (cm)</td><td>50</td></tr> <tr><td>Size</td><td>5-0 (1.0 metric)</td></tr> </table> <table border="1"> <tr><th colspan="2">Needle</th></tr> <tr><td>Length (mm)</td><td>11.0</td></tr> <tr><td>Curve</td><td>3/8</td></tr> <tr><td>Diam. (mm)</td><td>0.43</td></tr> </table>	Suture		Description	Silk, Black Braided	Length (cm)	50	Size	5-0 (1.0 metric)	Needle		Length (mm)	11.0	Curve	3/8	Diam. (mm)	0.43
Suture																			
Description	Silk, Black Braided																		
Length (cm)	50																		
Size	5-0 (1.0 metric)																		
Needle																			
Length (mm)	11.0																		
Curve	3/8																		
Diam. (mm)	0.43																		
AB-3855	<b>Silk Suture, Taper Point</b> Double-armed suture, measures 60cm in length. Taper point needle, measures 16.0mm in length, 3/8 curve, and 0.38mm in diameter.	<b>Double-Armed Taper Point</b> 	<table border="1"> <tr><th colspan="2">Suture</th></tr> <tr><td>Description</td><td>Silk, Black Braided</td></tr> <tr><td>Length (cm)</td><td>60</td></tr> <tr><td>Size</td><td>5-0 (1.0 metric)</td></tr> </table> <table border="1"> <tr><th colspan="2">Needle</th></tr> <tr><td>Length (mm)</td><td>16.0</td></tr> <tr><td>Curve</td><td>3/8</td></tr> <tr><td>Diam. (mm)</td><td>0.38</td></tr> </table>	Suture		Description	Silk, Black Braided	Length (cm)	60	Size	5-0 (1.0 metric)	Needle		Length (mm)	16.0	Curve	3/8	Diam. (mm)	0.38
Suture																			
Description	Silk, Black Braided																		
Length (cm)	60																		
Size	5-0 (1.0 metric)																		
Needle																			
Length (mm)	16.0																		
Curve	3/8																		
Diam. (mm)	0.38																		
AB-3856	<b>Silk Suture, Lancet</b> Double-armed suture, measures 50cm in length. Lancet needle, measures 11.0mm in length, 3/8 curve, and 0.38mm in diameter.	<b>Double-Armed Lancet</b> 	<table border="1"> <tr><th colspan="2">Suture</th></tr> <tr><td>Description</td><td>Silk, Black Braided</td></tr> <tr><td>Length (cm)</td><td>50</td></tr> <tr><td>Size</td><td>5-0 (1.0 metric)</td></tr> </table> <table border="1"> <tr><th colspan="2">Needle</th></tr> <tr><td>Length (mm)</td><td>11.0</td></tr> <tr><td>Curve</td><td>3/8</td></tr> <tr><td>Diam. (mm)</td><td>0.38</td></tr> </table>	Suture		Description	Silk, Black Braided	Length (cm)	50	Size	5-0 (1.0 metric)	Needle		Length (mm)	11.0	Curve	3/8	Diam. (mm)	0.38
Suture																			
Description	Silk, Black Braided																		
Length (cm)	50																		
Size	5-0 (1.0 metric)																		
Needle																			
Length (mm)	11.0																		
Curve	3/8																		
Diam. (mm)	0.38																		
AB-3856S	<b>Silk Suture, Lancet</b> Single-armed suture, measures 50cm in length. Lancet needle, measures 11.0mm in length, 3/8 curve, and 0.38mm in diameter.	<b>Single-Armed Lancet</b> 	<table border="1"> <tr><th colspan="2">Suture</th></tr> <tr><td>Description</td><td>Silk, Black Braided</td></tr> <tr><td>Length (cm)</td><td>50</td></tr> <tr><td>Size</td><td>5-0 (1.0 metric)</td></tr> </table> <table border="1"> <tr><th colspan="2">Needle</th></tr> <tr><td>Length (mm)</td><td>11.0</td></tr> <tr><td>Curve</td><td>3/8</td></tr> <tr><td>Diam. (mm)</td><td>0.38</td></tr> </table>	Suture		Description	Silk, Black Braided	Length (cm)	50	Size	5-0 (1.0 metric)	Needle		Length (mm)	11.0	Curve	3/8	Diam. (mm)	0.38
Suture																			
Description	Silk, Black Braided																		
Length (cm)	50																		
Size	5-0 (1.0 metric)																		
Needle																			
Length (mm)	11.0																		
Curve	3/8																		
Diam. (mm)	0.38																		

Sutures 4-0 Silk

Mani brand 4-0, black or white braided, silk sutures with both single and double arms. Taper point, reverse cut, cut taper, dia spatula, and lancet needles ranging in length, curve, and diameter. Mani sutures are ideal for micro-suturing on the cornea and sclera during eye surgery. Ultimate sharpness is obtained through the "cross-lapped edge" technique giving each suture a fine and sharp tip ensuring minimally invasive wound closure. Mani hard fiber stainless steel is used to make strong and break-resistant needles. Sold 12 per box.





AB-380I	<b>Silk Suture, Taper Point</b> Black braided, double-armed suture, measures 45cm in length. Taper point needle, measures 13.0mm in length, 3/8 curve, and 0.38mm in diameter.	<b>Double-Armed Taper Point</b> 	<table border="1"> <tr><th colspan="2">Suture</th></tr> <tr><td>Description</td><td>Silk, Black Braided</td></tr> <tr><td>Length (cm)</td><td>45</td></tr> <tr><td>Size</td><td>4-0 (1.5 metric)</td></tr> </table> <table border="1"> <tr><th colspan="2">Needle</th></tr> <tr><td>Length (mm)</td><td>13.0</td></tr> <tr><td>Curve</td><td>3/8</td></tr> <tr><td>Diam. (mm)</td><td>0.38</td></tr> </table>	Suture		Description	Silk, Black Braided	Length (cm)	45	Size	4-0 (1.5 metric)	Needle		Length (mm)	13.0	Curve	3/8	Diam. (mm)	0.38
Suture																			
Description	Silk, Black Braided																		
Length (cm)	45																		
Size	4-0 (1.5 metric)																		
Needle																			
Length (mm)	13.0																		
Curve	3/8																		
Diam. (mm)	0.38																		
AB-380IS	<b>Silk Suture, Taper Point</b> Black braided, single-armed suture, measures 45cm in length. Taper point needle, measures 13.0mm in length, 3/8 curve, and 0.38mm in diameter.	<b>Single-Armed Taper Point</b> 	<table border="1"> <tr><th colspan="2">Suture</th></tr> <tr><td>Description</td><td>Silk, Black Braided</td></tr> <tr><td>Length (cm)</td><td>45</td></tr> <tr><td>Size</td><td>4-0 (1.5 metric)</td></tr> </table> <table border="1"> <tr><th colspan="2">Needle</th></tr> <tr><td>Length (mm)</td><td>13.0</td></tr> <tr><td>Curve</td><td>3/8</td></tr> <tr><td>Diam. (mm)</td><td>0.38</td></tr> </table>	Suture		Description	Silk, Black Braided	Length (cm)	45	Size	4-0 (1.5 metric)	Needle		Length (mm)	13.0	Curve	3/8	Diam. (mm)	0.38
Suture																			
Description	Silk, Black Braided																		
Length (cm)	45																		
Size	4-0 (1.5 metric)																		
Needle																			
Length (mm)	13.0																		
Curve	3/8																		
Diam. (mm)	0.38																		



SILK

Item #	Description	Image	Suture	Needle												
AB-3851	<b>Silk Suture, Taper Point</b> Black braided, double-armed suture, measures 55cm in length. Taper point needle, measures 13.0mm in length, 3/8 curve, and 0.38mm in diameter.	<p><b>Double-Armed</b> <b>Taper Point</b></p>	<table border="1"> <tr><td>Description</td><td>Silk, Black Braided</td></tr> <tr><td>Length (cm)</td><td>55</td></tr> <tr><td>Size</td><td>4-0 (1.5 metric)</td></tr> </table>	Description	Silk, Black Braided	Length (cm)	55	Size	4-0 (1.5 metric)	<table border="1"> <tr><td>Length (mm)</td><td>13.0</td></tr> <tr><td>Curve</td><td>3/8</td></tr> <tr><td>Diam. (mm)</td><td>0.38</td></tr> </table>	Length (mm)	13.0	Curve	3/8	Diam. (mm)	0.38
Description	Silk, Black Braided															
Length (cm)	55															
Size	4-0 (1.5 metric)															
Length (mm)	13.0															
Curve	3/8															
Diam. (mm)	0.38															
AB-4300	<b>Silk Suture, Reverse Cut</b> Black braided, double-armed suture, measures 45cm in length. Reverse cut needle, measures 13.0mm in length, 7/16 curve, and 0.43mm in diameter.	<p><b>Double-Armed</b> <b>Reverse Cut</b></p>	<table border="1"> <tr><td>Description</td><td>Silk, Black Braided</td></tr> <tr><td>Length (cm)</td><td>45</td></tr> <tr><td>Size</td><td>4-0 (1.5 metric)</td></tr> </table>	Description	Silk, Black Braided	Length (cm)	45	Size	4-0 (1.5 metric)	<table border="1"> <tr><td>Length (mm)</td><td>13.0</td></tr> <tr><td>Curve</td><td>7/16</td></tr> <tr><td>Diam. (mm)</td><td>0.43</td></tr> </table>	Length (mm)	13.0	Curve	7/16	Diam. (mm)	0.43
Description	Silk, Black Braided															
Length (cm)	45															
Size	4-0 (1.5 metric)															
Length (mm)	13.0															
Curve	7/16															
Diam. (mm)	0.43															
AB-4351	<b>Silk Suture, Reverse Cut</b> Black braided, double-armed suture, measures 50cm in length. Reverse cut needle, measures 13.0mm in length, 3/8 curve, and 0.43mm in diameter.	<p><b>Double-Armed</b> <b>Reverse Cut</b></p>	<table border="1"> <tr><td>Description</td><td>Silk, Black Braided</td></tr> <tr><td>Length (cm)</td><td>50</td></tr> <tr><td>Size</td><td>4-0 (1.5 metric)</td></tr> </table>	Description	Silk, Black Braided	Length (cm)	50	Size	4-0 (1.5 metric)	<table border="1"> <tr><td>Length (mm)</td><td>13.0</td></tr> <tr><td>Curve</td><td>3/8</td></tr> <tr><td>Diam. (mm)</td><td>0.43</td></tr> </table>	Length (mm)	13.0	Curve	3/8	Diam. (mm)	0.43
Description	Silk, Black Braided															
Length (cm)	50															
Size	4-0 (1.5 metric)															
Length (mm)	13.0															
Curve	3/8															
Diam. (mm)	0.43															
AB-4351S	<b>Silk Suture, Reverse Cut</b> Black braided, single-armed suture, measures 50cm in length. Reverse cut needle, measures 13.0mm in length, 3/8 curve, and 0.43mm in diameter.	<p><b>Single-Armed</b> <b>Reverse Cut</b></p>	<table border="1"> <tr><td>Description</td><td>Silk, Black Braided</td></tr> <tr><td>Length (cm)</td><td>50</td></tr> <tr><td>Size</td><td>4-0 (1.5 metric)</td></tr> </table>	Description	Silk, Black Braided	Length (cm)	50	Size	4-0 (1.5 metric)	<table border="1"> <tr><td>Length (mm)</td><td>13.0</td></tr> <tr><td>Curve</td><td>3/8</td></tr> <tr><td>Diam. (mm)</td><td>0.43</td></tr> </table>	Length (mm)	13.0	Curve	3/8	Diam. (mm)	0.43
Description	Silk, Black Braided															
Length (cm)	50															
Size	4-0 (1.5 metric)															
Length (mm)	13.0															
Curve	3/8															
Diam. (mm)	0.43															
AB-5351	<b>Silk Suture, Taper Point</b> Black braided, double-armed suture, measures 75cm in length. Taper point needle, measures 16.0mm in length, 1/2 curve, and 0.53mm in diameter.	<p><b>Double-Armed</b> <b>Taper Point</b></p>	<table border="1"> <tr><td>Description</td><td>Silk, Black Braided</td></tr> <tr><td>Length (cm)</td><td>75</td></tr> <tr><td>Size</td><td>4-0 (1.5 metric)</td></tr> </table>	Description	Silk, Black Braided	Length (cm)	75	Size	4-0 (1.5 metric)	<table border="1"> <tr><td>Length (mm)</td><td>16.0</td></tr> <tr><td>Curve</td><td>1/2</td></tr> <tr><td>Diam. (mm)</td><td>0.53</td></tr> </table>	Length (mm)	16.0	Curve	1/2	Diam. (mm)	0.53
Description	Silk, Black Braided															
Length (cm)	75															
Size	4-0 (1.5 metric)															
Length (mm)	16.0															
Curve	1/2															
Diam. (mm)	0.53															
AB-4302S	<b>Silk Suture, Cut Taper</b> Black braided, single-armed suture, measures 75cm in length. Cut taper needle, measures 14.0mm in length, 3/8 curve, and 0.43mm in diameter.	<p><b>Single-Armed</b> <b>Cut Taper</b></p>	<table border="1"> <tr><td>Description</td><td>Silk, Black Braided</td></tr> <tr><td>Length (cm)</td><td>75</td></tr> <tr><td>Size</td><td>4-0 (1.5 metric)</td></tr> </table>	Description	Silk, Black Braided	Length (cm)	75	Size	4-0 (1.5 metric)	<table border="1"> <tr><td>Length (mm)</td><td>14.0</td></tr> <tr><td>Curve</td><td>3/8</td></tr> <tr><td>Diam. (mm)</td><td>0.43</td></tr> </table>	Length (mm)	14.0	Curve	3/8	Diam. (mm)	0.43
Description	Silk, Black Braided															
Length (cm)	75															
Size	4-0 (1.5 metric)															
Length (mm)	14.0															
Curve	3/8															
Diam. (mm)	0.43															
AB-4359	<b>Silk Suture, Lancet</b> Black braided, double-armed suture, measures 55cm in length. Lancet needle, measures 13.0mm in length, 3/8 curve, and 0.43mm in diameter.	<p><b>Double-Armed</b> <b>Lancet</b></p>	<table border="1"> <tr><td>Description</td><td>Silk, Black Braided</td></tr> <tr><td>Length (cm)</td><td>55</td></tr> <tr><td>Size</td><td>4-0 (1.5 metric)</td></tr> </table>	Description	Silk, Black Braided	Length (cm)	55	Size	4-0 (1.5 metric)	<table border="1"> <tr><td>Length (mm)</td><td>13.0</td></tr> <tr><td>Curve</td><td>3/8</td></tr> <tr><td>Diam. (mm)</td><td>0.43</td></tr> </table>	Length (mm)	13.0	Curve	3/8	Diam. (mm)	0.43
Description	Silk, Black Braided															
Length (cm)	55															
Size	4-0 (1.5 metric)															
Length (mm)	13.0															
Curve	3/8															
Diam. (mm)	0.43															
AB-4359S	<b>Silk Suture, Lancet</b> Black braided, single-armed suture, measures 50cm in length. Lancet needle, measures 13.0mm in length, 3/8 curve, and 0.43mm in diameter.	<p><b>Single-Armed</b> <b>Lancet</b></p>	<table border="1"> <tr><td>Description</td><td>Silk, Black Braided</td></tr> <tr><td>Length (cm)</td><td>50</td></tr> <tr><td>Size</td><td>4-0 (1.5 metric)</td></tr> </table>	Description	Silk, Black Braided	Length (cm)	50	Size	4-0 (1.5 metric)	<table border="1"> <tr><td>Length (mm)</td><td>13.0</td></tr> <tr><td>Curve</td><td>3/8</td></tr> <tr><td>Diam. (mm)</td><td>0.43</td></tr> </table>	Length (mm)	13.0	Curve	3/8	Diam. (mm)	0.43
Description	Silk, Black Braided															
Length (cm)	50															
Size	4-0 (1.5 metric)															
Length (mm)	13.0															
Curve	3/8															
Diam. (mm)	0.43															

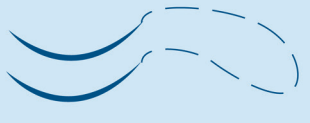
SILK

Item #	Description	Image																
AB-3857	<p><b>Silk Suture, Taper Point</b></p> <p>White braided, double-armed suture, measures 45cm in length. Taper point needle, measures 25.0mm in length, 7/16 curve, and 0.38mm in diameter.</p>	<div style="display: flex; justify-content: space-around;"> <div style="text-align: center;"> <p><b>Double-Armed</b></p>  </div> <div style="text-align: center;"> <p><b>Taper Point</b></p>  </div> </div> <table border="1" style="width: 100%; border-collapse: collapse;"> <thead> <tr> <th colspan="2">Suture</th> </tr> </thead> <tbody> <tr> <td>Description</td> <td>Silk, White Braided</td> </tr> <tr> <td>Length (cm)</td> <td>45</td> </tr> <tr> <td>Size</td> <td>4-0 (1.5 metric)</td> </tr> </tbody> </table> <table border="1" style="width: 100%; border-collapse: collapse;"> <thead> <tr> <th colspan="2">Needle</th> </tr> </thead> <tbody> <tr> <td>Length (mm)</td> <td>25.0</td> </tr> <tr> <td>Curve</td> <td>7/16</td> </tr> <tr> <td>Diam. (mm)</td> <td>0.38</td> </tr> </tbody> </table>	Suture		Description	Silk, White Braided	Length (cm)	45	Size	4-0 (1.5 metric)	Needle		Length (mm)	25.0	Curve	7/16	Diam. (mm)	0.38
Suture																		
Description	Silk, White Braided																	
Length (cm)	45																	
Size	4-0 (1.5 metric)																	
Needle																		
Length (mm)	25.0																	
Curve	7/16																	
Diam. (mm)	0.38																	
AB-4360	<p><b>Silk Suture, Dia Spatula</b></p> <p>White braided, double-armed suture, measures 60cm in length. Dia spatula needle, measures 6.5mm in length, 1/4 curve, and 0.43mm in diameter.</p>	<div style="display: flex; justify-content: space-around;"> <div style="text-align: center;"> <p><b>Double-Armed</b></p>  </div> <div style="text-align: center;"> <p><b>Dia Spatula</b></p>  </div> </div> <table border="1" style="width: 100%; border-collapse: collapse;"> <thead> <tr> <th colspan="2">Suture</th> </tr> </thead> <tbody> <tr> <td>Description</td> <td>Silk, White Braided</td> </tr> <tr> <td>Length (cm)</td> <td>60</td> </tr> <tr> <td>Size</td> <td>4-0 (1.5 metric)</td> </tr> </tbody> </table> <table border="1" style="width: 100%; border-collapse: collapse;"> <thead> <tr> <th colspan="2">Needle</th> </tr> </thead> <tbody> <tr> <td>Length (mm)</td> <td>6.5</td> </tr> <tr> <td>Curve</td> <td>1/4</td> </tr> <tr> <td>Diam. (mm)</td> <td>0.43</td> </tr> </tbody> </table>	Suture		Description	Silk, White Braided	Length (cm)	60	Size	4-0 (1.5 metric)	Needle		Length (mm)	6.5	Curve	1/4	Diam. (mm)	0.43
Suture																		
Description	Silk, White Braided																	
Length (cm)	60																	
Size	4-0 (1.5 metric)																	
Needle																		
Length (mm)	6.5																	
Curve	1/4																	
Diam. (mm)	0.43																	

# Surgical Disposables

APPAREL

Item #	Description	Image
--------	-------------	-------

**Exam Gown**

Exam gowns are an efficient way to offer patients a high level of privacy during exams while saving your facility laundry expenses. These disposable gowns are blue in color and designed with the patient's comfort in mind, while staying at an affordable price. Non-sterile and latex-free. Sold 50 per box.

AXI5194

**Large Exam Gown**

Medline patient gown that is made from a multi-layer fabric. Can be worn with opening in the front or back and the tie is attached to the gown for a snug fit. Regular/large in size with short sleeves.



AXI2076

**Universal Exam Gown**

McKesson exam gown that is made from 3-ply tissue/poly/tissue. Comes with a waist belt and measures 30 x 42 inches and fits most adults. Sleeves are short with no cuffs.



**Isolation and Fluid-Resistant Surgical Gown**

McKesson Isolation and Fluid-Resistant Gowns are designed for comfort and flexibility of movement. They are made of a non-woven, durable material and feature elastic cuffs. These disposable gowns are non-sterile and are not made with natural rubber latex. Non-sterile, disposable.



AXI3284

**X-Large Surgical Gown**

McKesson Protective Procedure Gown is made from polyethylene-coated, spunbonded polypropylene. Gown is yellow, long sleeves with elastic cuffs that fit snugly under gloves, unisex, and x-large adult size. Full back with neck and waist ties that offer individual size adjustment. Sold 10 per bag.



APPAREL

Item #	Description	Image
AXI2077	<p><b>Universal Surgical Gown, Blue</b></p> <p>Medi-Pak Performance Fluid-Resistant Gown is made from polyethylene-coated, spunbonded polypropylene. Gown is blue, long sleeves with elastic cuffs that fit snugly under gloves, unisex, and adult unisize. Open back with neck and waist ties that offer individual size adjustment. Sold 50 per box.</p>	
AXII795	<p><b>Universal Surgical Gown, White</b></p> <p>Medi-Pak Performance Fluid-Resistant Gown is made from polyethylene-coated, spunbonded polypropylene. Gown is white, long sleeves with elastic cuffs that fit snugly under gloves, unisex, and adult unisize. Full back with neck and waist ties that offer individual size adjustment. Sold 10 per box.</p>	
AXI3328	<p><b>Universal Surgical Gown</b></p> <p>McKesson Fluid-Resistant Gown is made from polypropylene. Gown is yellow, long sleeves with elastic cuffs that fit snugly under gloves, unisex, and adult unisize. Full back with neck and waist ties that offer individual size adjustment. Sold 50 per box.</p>	

**Non-Skid Shoe Cover**

Blue, non-skid shoe covers offer improved floor traction while having an elastic opening that provides a snug comfortable fit. Made from spunbound polypropylene. Latex-free and non-skid.

AXI3364	<p><b>Sport Shoe Cover</b></p> <p>Medline shoe cover made from spunbound polypropylene that is a breathable, fluid-repellent material. Blue cover with an elastic band for closure. Sport size fits almost any athletic shoe. Sold 100 per box.</p>	
---------	---	--



## APPAREL

Item #	Description	Image
AX11642	<p><b>Large Shoe Cover</b></p> <p>Medline shoe cover made from spunbound polypropylene that is a breathable, fluid-repellent material. Blue cover with an elastic band for closure. Regular/large size fits up to men's size 12 but is generously sized for full-coverage protection. Sold 100 per box.</p>	
AX11250	<p><b>X-Large Shoe Cover</b></p> <p>Medline shoe cover made from spunbound polypropylene that is a breathable, fluid-repellent material. Blue cover with an elastic band for closure. X-large size fits up to men's size 15 but is generously sized for full-coverage protection. Sold 100 per box.</p>	
AX0208	<p><b>X-Large Shoe Cover</b></p> <p>Medline shoe cover made from spunbound polypropylene that is a breathable, fluid-repellent material. Blue cover with an elastic band for closure. X-large size fits up to men's size 15 but is generously sized for full-coverage protection. Sold 200 per box.</p>	
AX10735	<p><b>Universal Shoe Cover</b></p> <p>Dynarex shoe cover made from spunbound polypropylene that is sewn together instead of glued and offers greater strength. Blue cover with an elastic band for closure. Universal in size, fitting shoes small to large. Non-conductive. Sold 100 per box.</p>	



APPAREL

Item #	Description	Image
--------	-------------	-------

**Smooth Bottom Shoe Cover**

Smooth covers are ideal for jobs that do not require a non-skid tread. Made from spunbound polypropylene that is sewn together instead of glued, offering greater strength. Latex-free. Dynarex blue shoe cover with an elastic band for a snug comfortable closure. Universal in size, fitting shoes small to large, non-conductive, and sold 100 per box.

AXI0388	<b>Universal Shoe Cover</b>
---------	-----------------------------



**McKesson Bouffant Cap**

Bouffant cap made from non-sterile spunbound polypropylene that is lightweight but durable and permits increased airflow, keeping the wearer cool and comfortable during long surgical procedures. Latex-free. Blue cap with elastic band for closure. Sold 100 per box.

AXI4051	<b>Large Bouffant Cap</b> 21-inch large size.
---------	--

AXI4488	<b>X-Large Bouffant Cap</b> 24-inch x-large size.
---------	--



**Pro Series Bouffant Cap**

Medline Pro Series Bouffant Caps comply with NFPA standards and are made from lightweight multi-ply polypropylene, which results in less linting. Double-stitched elastic band keeps caps flat and comfortable on the forehead. Latex-free. Butterfly printed cap with elastic band for closure. 24-inch large/regular size. Sold 500 per case.

AXI4349	<b>Butterfly Bouffant Cap</b>
---------	-------------------------------



APPAREL

Item #	Description	Image
--------	-------------	-------

**Single-Ply Bouffant Cap**

Medline caps are made of single-ply spunbond polypropylene, which results in less linting and is latex-free. Caps comply with NFPA standards and have double-stitched elastic band for closure that keeps caps flat and comfortable on the forehead. Sold 100 per bag.

AXI0923	<p><b>Medium Bouffant Cap, Blue</b> Blue cap, 21-inch medium size.</p>	
---------	--	--



AXI0240	<p><b>Large Bouffant Cap, White</b> White cap, 24-inch large/regular size.</p>	
---------	--	---



AXII593	<p><b>Large Bouffant Cap, Blue</b> Blue cap, 24-inch large/regular size.</p>	
---------	--	--



APPAREL

Item #	Description	Image
<b>Surgeon Cap</b>		
Blue surgeon caps that feature traditional tie-on styling. Uses comfortable material that is ideal for extended wearing during surgeries. One size fits most. Sold 100 per box.		
AXI3251	<p><b>McKesson Surgeon Cap</b></p> <p>McKesson surgeon cap is made from blue scrim-reinforced, soft and absorbent material, with wide panel sides, ventilated crown, and adjustable fastening ties. Non-sterile and latex-free.</p>	
AXI5314	<p><b>Cardinal Surgeon Cap</b></p> <p>Cardinal blue nonwoven cap features traditional tie-on styling, providing you with a comfortable fit without binding. Features absorbent non-sterile polyester top for breathability and comfort. Contains latex.</p>	
AXI1823	<p><b>Halyard Surgeon Cap</b></p> <p>Halyard surgeon cap is made from blue Kaycel material, and has adjustable fastening ties. Best suited for use in situations where there is no fluid contamination anticipated. Non-sterile.</p>	

APPAREL

Item #	Description	Image
--------	-------------	-------

**Surgical Gown**

These surgical gowns are extremely comfortable and provide the right level of protection during surgeries.

**AXI5490**      **Small Surgical Gown**

Halyard sterile surgical gown is made from polypropylene, which is a low-linting fabric. Gown is blue, long sleeve, and small adult in size. Includes towel, knit cuffs, closed back, and adjustable neckline with 3-snap closure. Sold 34 per box.



**AXI0502**      **Large Surgical Gown**

Halyard sterile surgical gown is made from polypropylene, which is a low-linting fabric. Gown is blue, long sleeve, non-reinforced, and large adult in size. Includes towel, knit cuffs, closed back, and adjustable neckline with 2-snap closure. Sold 36 per box.

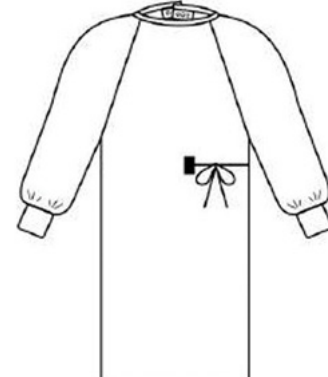

**AXI4906**      **Large Surgical Gown**

The Aurora line provides an unbeatable combination of extreme comfort and high protection. No compromise is necessary with a premium blue fabric that's also incredibly strong. The fabric's high hydrostatic head protects the wearer, and its extreme breathability leaves the wearer feeling cool and unrestricted during procedures. AAMI level 3 protection. The gown is sterile, large in size, and closes with a hook and loop. Sold 30 per box.

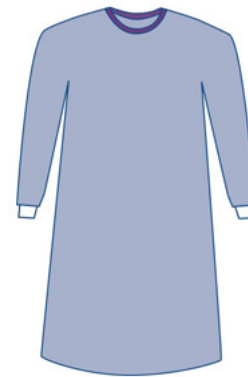

**AXI3262**      **Large Surgical Gown**



Astound sterile surgical gown is made from 3-layer microfiber, which is classified as AAMI level 3. Gown is blue, non-reinforced, long sleeve, and large adult in size. Includes towel, knit cuffs, closed back, and side tie closure. Sold 20 per box.



APPAREL

Item #	Description	Image
AXI2039	<p><b>X-Large Surgical Gown</b></p> <p>Halyard sterile surgical gown is made from polypropylene, which is a low-linting fabric. Gown is blue, long sleeve, and x-large adult in size. Includes towel, knit cuffs, closed back, and adjustable neckline with 3-snap closure. Sold 30 per box.</p>	

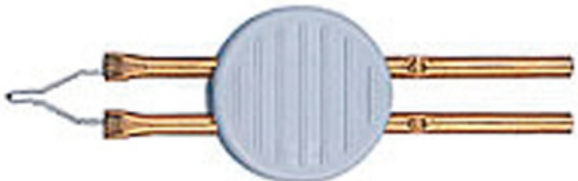
CAUTERIES

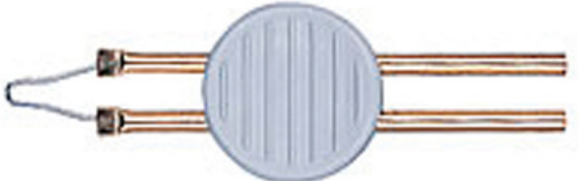
Item #	Description	Image
<p><b>Change-a-Tip Cautery</b></p> <p>These replaceable battery and replaceable tip cauteries are the next advance in battery-operated cauteries where reusability is a must. These products are excellent for the office, ER, and clinical procedures.</p>		
AXII640	<p><b>High-Temp Handle Replacement</b></p> <p>Bovie high-temperature handle that includes one fine-tip non-sterile tip and one "AA" alkaline battery. Sold 1 per box.</p>	
AXII943	<p><b>High-Temp Tip Replacement</b></p> <p>Bovie high-temperature non-sterile fine-tip cauterizing tip. Replacement for Change-a-Tip handles. Sold 10 per box.</p>	
AXI3426	<p><b>Low-Temp Tip Replacement</b></p> <p>Bovie low-temperature non-sterile fine-tip cauterizing tip. Replacement for Change-a-Tip handles. Sold 10 per box.</p>	
AXI4343	<p><b>Low-Temp Handle Replacement</b></p> <p>Bovie low-temperature handle that includes one fine-tip non-sterile tip and one "AA" alkaline battery. Sold 1 per box.</p>	
AXI5372	<p><b>High-Temp Tip Replacement</b></p> <p>Bovie high-temperature non-sterile loop-tip cauterizing tip. Replacement for Change-a-Tip handles. Sold 10 per box.</p>	



CAUTERIES

Item #	Description	Image
--------	-------------	-------

**High-Temperature Cautery**

High-temperature cauteries are popular for many types of procedures, including pinpoint hemostasis, evacuation of a subungual hematoma, controlling diffuse bleeders, and sculpting woven grafts. Cauteries are individually packaged, sterile, and sold 10 per box.

**AXI0170** **Fine-Tip Cautery**  
 Bovie high-temperature (2,200°F) fine-tip cautery. Protective cover cap is included for storage and safe disposal.



**AXI0319** **Loop-Tip Cautery**  
 Medi-Pak high-temperature (2,200°F) loop-tip cautery.



**AXI4250** **Microfine-Tip Cautery**  
 Bovie high-temperature (2,000°F) microfine-tip cautery. Protective cover cap is included for storage and safe disposal.



**Low-Temperature Cautery**

With a variety of low temperatures and fine tips the surgeon is ensured precise pinpoint hemostasis. These cauteries can be used in a variety of ophthalmic procedures. Cauteries are individually packaged, sterile, and sold 10 per box.

**AXI0339** **Fine-Tip Cautery**  
 Bovie low-temperature (1,300°F) fine-tip cautery. Protective cover cap is included for storage and safe disposal.



**AXI1971** **Microfine-Tip Cautery**  
 Bovie low-temperature (850°F) microfine-tip cautery. Protective cover cap is included for storage and safe disposal.



**AXI5167** **Fine-Tip Cautery**  
 Accu-Temp low-temperature (1200°F) fine-tip cautery.







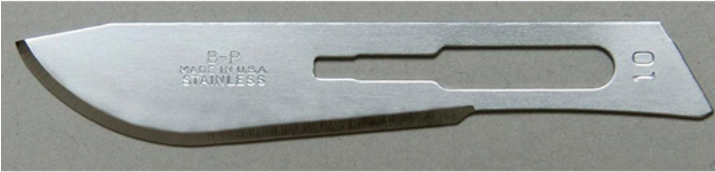

CAUTERIES

Item #	Description	Image
<b>Eye Bubble</b>		
The Bovie eye bubble is a clear protective bubble that is to be used for ophthalmic procedures. Sold 10 per box.		
AXI5014	<a href="#">Eye Bubble</a>	

SCALPELS & BLADES

Item #	Description	Image
<b>BD Bard-Parker Scalpel Blade</b>		
Offers the superior cutting advantages of carbon steel technology, including consistent sharpness, control, and strength. Packaged for safety and ease of use. Sterile. Sold 50 per box.		
AXI5390	<a href="#">#10 Blade</a> Size 10 scalpel blade.	
AXI0919	<a href="#">#11 Blade</a> Size 11 scalpel blade. Carbon steel rib-back.	
AXI3981	<a href="#">#11 Blade</a> Size 11 scalpel blade. Stainless steel.	
AXI0126	<a href="#">#15 Blade</a> Size 15 scalpel blade. Carbon steel rib-back.	

SCALPELS & BLADES

Item #	Description	Image
--------	-------------	-------

**Beaver Mini-Blade**

Beaver's Mini-Blades are manufactured using a proprietary grindless technology that yields consistent sharpness and blade geometry and are available in a variety of designs to meet all small incision and excision needs. Beaver Mini-Blades are preassembled into a unique, patented tip, designed for safe assembly and ease of use. Each mini-blade is color coded for easy identification and has a screw handle. Sterile. Sold 20 per box.

AXI3843	<p><b>#64 Blade</b></p> <p>Size 64 blade that is grindless, rounded tip, and sharp on one side. Green.</p>
---------	--



AXI5329	<p><b>#69 Blade</b></p> <p>Size 69 blade that is grindless, straight, sharp all around, 180-degree cutting surface, and double bevel blade. Blue.</p>
---------	---



**Change-a-Blade Safety Scalpel Handle**

This size 3 handle allows the surgeon to use the preferred choice of blade while eliminating hazard with a protective safety shield. Requires no change in surgeon's technique. Blade can be changed as often as needed throughout procedure. Same width, puncture-ability and visibility as a traditional scalpel handle. Sterile. Sold 48 per case.

AXI5435	<b>Change-a-Blade</b>
---------	-----------------------

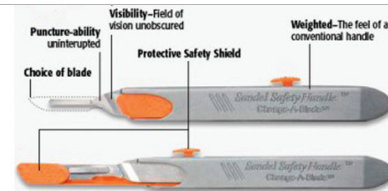

**Cincinnati Lance Blade**

Size 11 lance blade comes sterile. Lance sterile surgical blades enjoy the reputation for consistently longer lasting, unequaled cutting edges. All blades are individually wrapped in a peel-open package. Sterile. Sold 100 per box.

AXI0905	<b>Cincinnati Lance Blade</b>
---------	-------------------------------



SCALPELS & BLADES

Item #	Description	Image
--------	-------------	-------

**Cincinnati Surgical Blade Remover**

The C/S blade remover assists in the safe removal of blades, thereby greatly reducing the risk of injury and infection. When ready to discard, the unit and its contents may be safely autoclaved and disposed of in a proper manner. Sold 10 per box.

AXI4249      **Blade Removal System**



**Cincinnati Surgical Blade**

Cincinnati Surgical blades have an unmatched reputation for quality. Both the stainless and carbon blades are manufactured of high grade British surgical steel, resulting in exceptional durability and sharpness. Individually wrapped in an easy-to-use peel-open package. Sterile. Sold 100 per box.

AXI5052      **Surgical Blade #12**  
Size I2 surgical blade.



AXI3360      **Surgical Blade #10**  
Size I0 surgical blade.









AX9810      **Surgical Blade #11**  
Size I1 surgical blade.





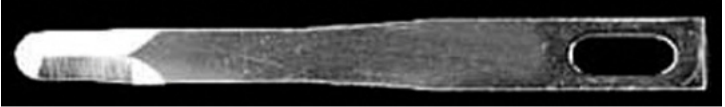

AX9811      **Surgical Blade #15**  
Size I5 surgical blade.



## SCALPELS &amp; BLADES

Item #	Description	Image
<b>Miltex General-Purpose Blade</b>		
Stainless steel general-purpose blades are disposable and provide a smooth, sharp edge for a precise incision. Sterile. Sold 100 per box.		
AXI4189	<b>Blade #11</b> Size 11 blade.	
AXI5555	<b>Blade #15</b> Size 15 blade.	
<b>Miniature Surgical Blade</b>		
Sharp miniature blades that are made from high-quality surgical stainless steel and are designed for precise incisions. Sterile.		
AXI0439	<b>Cincinnati Blade #64</b> Size 64 miniature blade. Sold 25 per box. Manufactured by Cincinnati Surgical.	
AXI0438	<b>Cincinnati Blade #65</b> Size 65 miniature blade. Sold 25 per box. Manufactured by Cincinnati Surgical.	
AXI3195	<b>Cincinnati Blade #67</b> Size 67 miniature blade. Sold 25 per box. Manufactured by Cincinnati Surgical.	
AXI1011	<b>Cincinnati Blade #69</b> Size 69 miniature blade. Sold 25 per box. Manufactured by Cincinnati Surgical.	
AXI3055	<b>Surgistar Blade</b> 15-degree pointed lance blade. Sold 12 per box. Manufactured by Surgistar.	

SCALPELS & BLADES

Item #	Description	Image
AXI4137	<p><b>Surgistar Blade</b></p> <p>Miniature blade with a round tip, sharp all around, and straight. Sold 6 per box. Manufactured by Surgistar.</p>	
AXI5106	<p><b>Surgistar Blade</b></p> <p>Miniature blade with a curved tip and sharp on one side. Sold 12 per box. Manufactured by Surgistar.</p>	
AXI5325	<p><b>Surgistar Blade</b></p> <p>Miniature blade with a round tip and sharp on one side. Sold 12 per box. Manufactured by Surgistar.</p>	
AXI5324	<p><b>Surgistar Blade</b></p> <p>Miniature blade with a 1.5mm chisel tip. Sold 12 per box. Manufactured by Surgistar.</p>	

**Size 10 Disposable Scalpel**

Size 10 sterile scalpels incorporate superior stainless steel blades on uniquely designed handles. Each scalpel is supplied with a flexible blade cover for complete user protection. Sterile. Sold 10 per box.

AXI1213	<p><b>Scalpel #10</b></p>	
---------	---------------------------	--

**Size 11 Disposable Scalpel**

Size 11 sterile scalpels incorporate superior stainless steel blades on uniquely designed handles. Sterile. Sold 10 per box.

AXI0055	<p><b>Cincinnati Scalpel</b></p> <p>Size 11 scalpel. Cincinnati Surgical scalpels incorporate superior stainless steel blade on a uniquely designed handle. Each scalpel is supplied with a flexible blade cover for complete user protection.</p>	
AXI4179	<p><b>Miltex Scalpel</b></p> <p>Size 11 scalpel. Manufactured by Miltex.</p>	



SCALPELS & BLADES

Item #	Description	Image
AXI4191	<p><b>Bard-Parker Scalpel</b></p> <p>Size II scalpel. Manufactured by Aspen Surgical Products.</p>	

**Size II Safety Disposable Scalpel**

Size II safety scalpels are designed to minimize the risk of surgical blade injuries with a retractable shield or retractable blade. Allows clinicians to easily and safely operate with one hand. Sterile. Sold 10 per box.

AXI5249	<p><b>Moore Scalpel</b></p> <p>Size II scalpel with a protective sheath that covers the blade, safeguarding against accidental cuts when removing the scalpel from the package, while passing the scalpel, and during disposal. Manufactured by Moore Medical.</p>	
---------	--	--

AXI3986	<p><b>Miltex Blade</b></p> <p>Size II safety retractable blade. Manufactured by Miltex.</p>	
---------	---	--

AXI5160	<p><b>Aspen Blade</b></p> <p>Size II safety scalpel with retractable, locking shield. Manufactured by Aspen Surgical Products.</p>	
---------	--	--

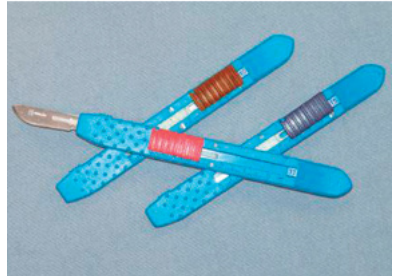
AXI4280	<p><b>McKesson Blade</b></p> <p>Medi-Pak Performance safety scalpel with retractable blade that has three positions: USE, PASS, and DISPOSE, with steadfast disposal lock. Locks into USE position. Disposal lock status indicator. Manufactured by McKesson.</p>	
---------	---	--

**Size 15 Disposable Scalpel**

Size 15 sterile scalpels that incorporate superior stainless steel blades on uniquely designed handles. Sterile. Sold 10 per box.

AXI0095	<p><b>Cincinnati Scalpel</b></p> <p>Size 15 scalpel. Superior stainless steel blade on a uniquely designed handle. Each scalpel is supplied with a flexible blade cover for complete user protection. Manufactured by Cincinnati Surgical.</p>	
---------	--	--



SCALPELS & BLADES

Item #	Description	Image
--------	-------------	-------

AXI1941 **Miltex Scalpel**  
Size 15 scalpel. Manufactured by Miltex.



AXI4348 **BD Scalpel**  
Size 15 scalpel. Manufactured by Aspen Surgical Products.



**Size 15 Safety Disposable Scalpel**

Size 15 safety scalpel designed to minimize the risk of surgical blade injuries with a retractable shield or retractable blade. Allows clinicians to easily and safely operate with one hand. Sterile. Sold 10 per box.

AXI1940 **Miltex Scalpel**  
Size 15 safety scalpel with retractable blade. Manufactured by Miltex.



AXI5161 **BD Scalpel**  
Size 15 safety scalpel with retractable, locking shield. Manufactured by Aspen Surgical Products.



AXI5190 **McKesson Scalpel**  
Medi-Pak Performance safety scalpel with retractable blade that has three positions: USE, PASS, and DISPOSE, with steadfast disposal lock. Locks into USE position. Disposal lock status indicator. Manufactured by McKesson.

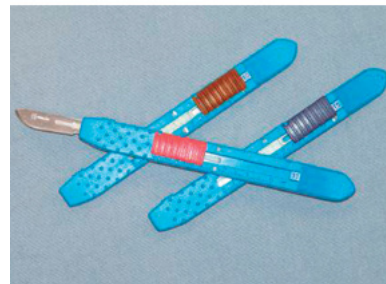



**Size 21 Disposable Scalpel**

Size 21 scalpel that comes sterile. Cincinnati Surgical scalpels incorporate superior stainless steel blade on a uniquely designed handle. Each scalpel is supplied with a flexible blade cover for complete user protection. Sold 10 per box.

AXI1240 **Handle and Blade #21**



SCALPELS & BLADES

Item #	Description	Image
<b>Surgistar Handle and Blade</b>		
Various types of blades that slide into handles as well as full handle and blade sets. Manufactured by Surgistar. Sterile. Sold 6 per box.		
AXI3207	<b>Blade #57</b> Scleral blade only that slides into a handle, #57. Standard US style.	
AXI4262	<b>Blade #66</b> Lamellar blade only that slides into a handle, #66. Angled tip, bevel up.	
AXI4425	<b>Handle and Blade #57</b> Scleral blade and handle set, #57. Standard US style.	

DRAPES

Item #	Description	Image
<b>Adhesive Towel Drape</b>		
These towel drapes feature an aggressive adhesive that leaves no residue, a non-linting, tear-resistant poly release liner, and a strong, drapable, low-glare matte finish film. Sterile. Sold 10 per box.		
AXI0146	<b>Surgical Towel, Short</b> This towel drape measures 18" x 12" and the adhesive area measures 18" x 1.5".	 <p>18" (45 cm)</p> <p>12" (30 cm)</p> <p>KEY:  Adhesive  Matte Film</p>

DRAPES

Item #	Description	Image
AXI0508	<p><b>Surgical Towel, Long</b></p> <p>Large towel drape measures 18" x 24" and the adhesive area measures 18" x 2".</p>	<p>18" (45 cm)</p> <p>24" (60 cm)</p> <p>KEY: Adhesive Matte Film</p>

Aperture Drape

Circular aperture with adhesive area. Non-linting, tear-resistant, waxy paper release liner. Thin, soft, drapeable, low-glare matte-finish film. Sterile.

AXI3164	<p><b>Aperture Drape</b></p> <p>Aperture drape measuring 16" x 16" with 2.5" circular aperture and 5" x 5" adhesive area. Sold 10 per box.</p>	<p>16" (40 cm)</p> <p>16" (40 cm)</p> <p>KEY: Adhesive Matte Film</p>
---------	--	---

AXI0591	<p><b>Minor Procedure Drape</b></p> <p>2.5" circular aperture with an adhesive area that measures 4.5" x 5". Drape measures 24" x 26". Great for minor procedures. Sold 25 per box.</p>	<p>24" (60 cm)</p> <p>26" (66 cm)</p> <p>KEY: Adhesive Absorbent Material</p>
---------	---	---

DRAPES

Item #	Description	Image
--------	-------------	-------

**Aperture Pouch Drape**

Drape measures 19" x 15" with an oval aperture that measures 2.4" x 1.4". Adhesive around aperture measures 5" x 4" and adhesive tabs measure 2" x 2". Oval aperture with adhesive optimized for skin. Non-linting, tear-resistant, waxy paper release liner. Two adhesive tabs for additional support. Moldable strip for additional fluid control. Soft, drapeable, low-glare matte-finish film. Sterile. Sold 10 per box.

AXII696	<b>Aperture Pouch Drape</b>	
---------	-----------------------------	--

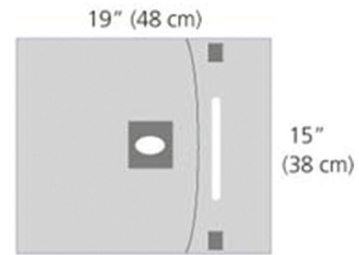

KEY:  Adhesive  Matte Film

**Convertors Mayo Stand Cover**

Sterile, single-use, reinforced poly mayo stand cover. Measures 22.75" x 55.5". Sold 30 per box.

AXII750	<b>Mayo Stand Cover</b>	
---------	-------------------------	--

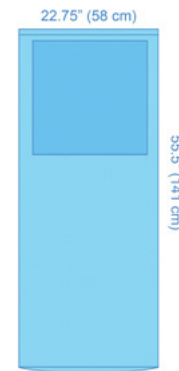

**Convertors Refractive Drape**

Sterile, 2-piece drape with circle aperture. Adhesive square around aperture area. For use in LASIK, refractive, corneal, and lid/plastic procedures. Overall size is 16" x 10.75". Aperture measures 1.5" x 0.98" and adhesive area is 3" x 3". Sold 10 per box.

AXIO432	<b>Convertors Refractive Drape</b>	
---------	------------------------------------	--

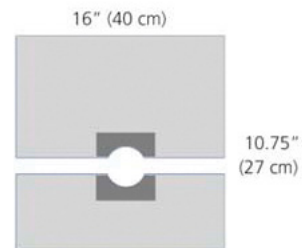

KEY:  Adhesive  Matte Film

DRAPES

Item #	Description	Image
--------	-------------	-------

**Drape Cover**

Clear, sterile poly cover used to cover table, as a barrier sheet or set up cover. Measures 44" x 72". Sold 25 per box.

AXI1033 **Drape Cover**

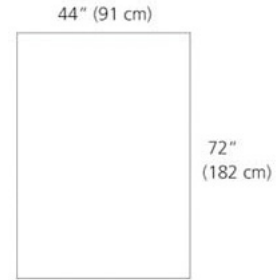

KEY:  Clear Film

**General-Purpose Drape**

General-purpose drapes. Unfenestrated and without pouches.

AXI3674 **Physical Exam Drape**

Nonsterile, general-purpose physical exam drape measuring 40" x 48". 2-ply, white, pebble-embossed, tissue drape. Sold 100 per box.







AXI4908 **Half Drape**

Sterile convertors, general-purpose half drape measuring 44" x 57". Sold 20 per box.

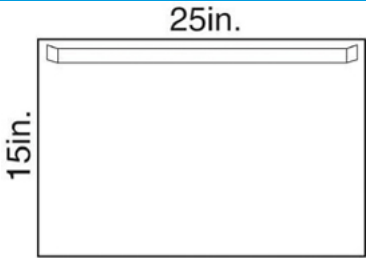

DRAPES

Item #	Description	Image
AXI1929	<p><b>Utility Drape</b></p> <p>A 2-pack of sterile utility drapes measuring 25" x 15" with adhesive tape. Sold 2 drapes per pack and 100 packs per box.</p>	
AXI3185	<p><b>Towel Drape</b></p> <p>Sterile, general-purpose Best Value towel drape measuring 15" x 26" with adhesive strip. Sold 2 per pack.</p>	
AXI4105	<p><b>Three-Quarter Drape</b></p> <p>Sterile general-purpose Convertors Tiburon three-quarter drape. Measures 57" x 76" and is made with Tiburon fabric. Sold 20 per box.</p>	
AXI1506	<p><b>X-Large Drape</b></p> <p>Extra-large general-purpose drape measuring 77" x 98". Sterile. Sold 12 per box.</p>	



DRAPES

Item #	Description	Image
--------	-------------	-------

AXI2042 **Half Drape**  
Sterile, general-purpose half drape measuring 60" x 44". Sold 54 per box.

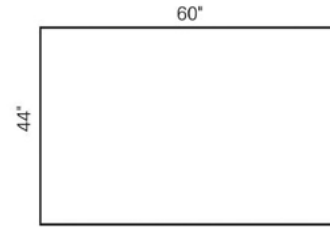

AXI3441 **Half Drape**  
Sterile half surgical drape measures 40" x 58". Top-of-the-line SMS fabric, composed of five strong fiber layers for exceptionally high barrier strength. Made of 100% polypropylene, SMS drapes are soft and drapeable. Composed with the latest generation SMS technology, drapes have smaller fibers and a more uniform fiber lay-down. Sold 20 per box.



**Incise Drape**

Sterile incise drape. Thin, conformable, low-glare matte finish film. Aggressive adhesive with no residue. Sold 10 per box.

AXO951 **Mini Incise Drape**  
EENT mini incise drape with adhesive center. Drape measures 6.5" x 7.5" with an adhesive area measuring 4" x 7.5".

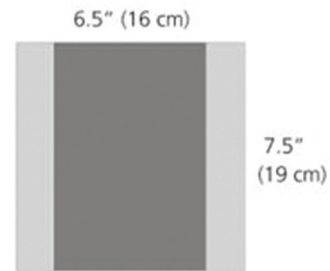

KEY: Adhesive Matte Film

AXII886 **Medium Incise Drape**  
Incise drape measures 16" x 16" with an adhesive area measuring 5" x 5".

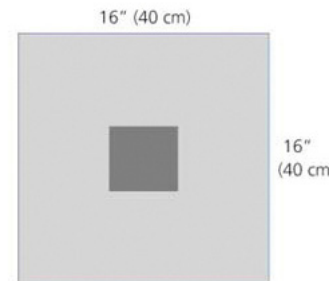

KEY: Adhesive Matte Film

DRAPES

Item #	Description	Image
--------	-------------	-------

AXI0560 **Large Incise Drape**  
 Incise drape measures 36" x 33" with an adhesive area measuring 23.5" x 33".

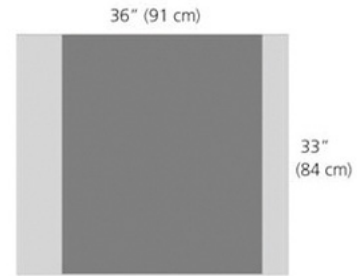

KEY: Adhesive Matte Film

AXI3424 **X-Large Incise Drape**  
 Incise drape measures 48" x 51" with an adhesive area measuring 5" x 4.5".

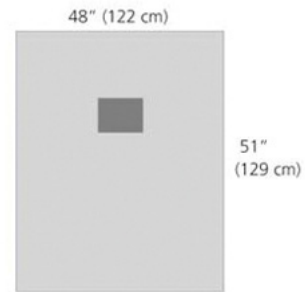

KEY: Adhesive Matte Film

**Incise Drape with Pouch**

Drape measures 48" x 51". Adhesive area measures 5" x 4.5" and pouch measures 10" x 11". Incise adhesive area. Non-linting, tear-resistant, waxy paper release liner. Fluid pouch with moldable strip for additional fluid control. Soft, drapeable, low-glare matte-finish film. Sterile. Sold 10 per box.

AXI0830 **Incise Drape with Pouch**

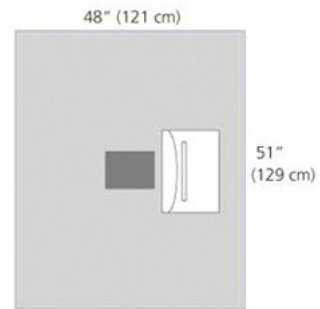

KEY: Adhesive Matte Film Clear Film

DRAPES

Item #	Description	Image
--------	-------------	-------

**Instrument Cover**

Large instrument cover measures 24" x 18". Used to cover instruments or mayo stand. This drape features a strong, clear, poly film that is transparent for improved observation and provides a barrier to fluids. It also features an aggressive adhesive strip with no residue. Sterile. Sold 10 per box.

AXI0525	Instrument Cover
---------	------------------

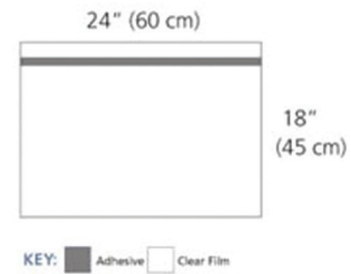

**Medi-Pak Performance Drape**

Minor procedure Medi-Pack performance sterile field drape measures 18" x 26". Made out of tissue and poly. Unfenestrated. Sterile. Sold 50 per box.

AXI4994	Medi-Pak Performance Drape
---------	----------------------------



**Poly U Drape**

Drape measures 48" x 52". Adhesive area measures 10" x 19" and "U" fenestration measures 6" x 19". "U" fenestration with wide adhesive area. Advanced adhesive provides excellent adhesion with no residue. Strong, drapeable, low-glare matte-finish film. Split, waxy paper liner for ease of application. Sterile. Sold 10 per box.

AXII032	Poly U Drape
---------	--------------

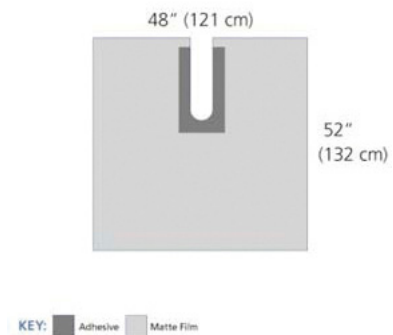

DRAPES

Item #	Description	Image
--------	-------------	-------

**Split Sheet Drape**

Sterile Convertors Tiburon split sheet drape measures 77" x 108". With absorbent Iso Bac reinforcement measuring 28" x 38" and split adhesive. Surgical area measures 37" x 2.5". Sold 10 per box.

AXI4460 **Split Sheet Drape**

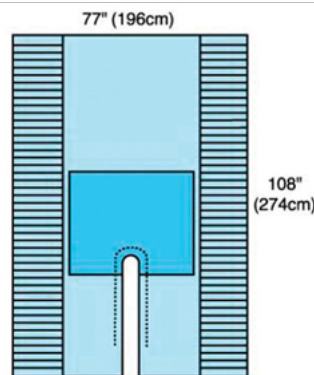

**Towel Drape**

Disposable, sterile towel drapes for use in minor surgical or therapeutic procedures where a sterile field or drape is required. Poly-interlined, 3-ply construction – tissue/poly/tissue – provides absorbency while preventing possible moisture or bacteria migration. Sold 50 per box.

AXII347 **Non-Fenestrated Drape**

Drape measures 18" x 26" and is non-fenestrated.



AXII419 **Fenestrated Drape**

Drape measures 18" x 26". Has 2.75" fenestrated opening.



## EYE SHIELDS

Item #	Description	Image
--------	-------------	-------

**Blue Eye Shield**

Blue non-sterile polycarbonate pinhole shield, universal size with deep shell. Does not have guarder or padded lining. Sold 50 per box.

AXI0494

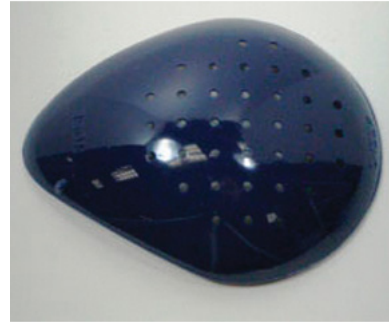
**Non-Sterile Blue Eye Shield****Clear Eye Shield**

Clear polycarbonate and plastic shields that allow for maximum comfort and protection for post-operative patients. Shields come sterile or non-sterile and are vented to reduce fogging. Adult and youth universal sizing with deep and standard shells.

AXI0445

**Non-Sterile Clear Eye Shield**

Clear non-sterile polycarbonate vented shield, universal size with deep shell. Does not have guarder or padded lining. Sold 50 per box.

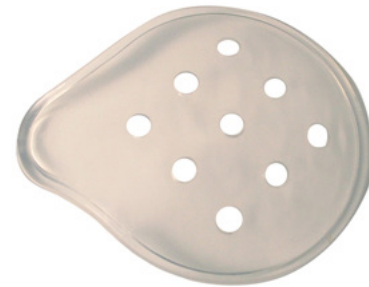

AXI2010

**Non-Sterile Clear Eye Shield**

Clear non-sterile polycarbonate vented shield, universal size with deep shell. Does not have guarder or padded lining. Sold 100 per box.

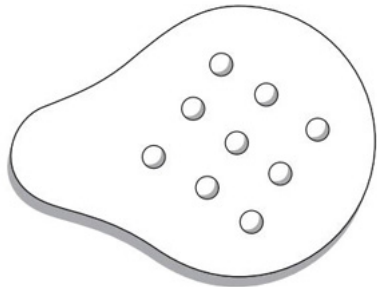
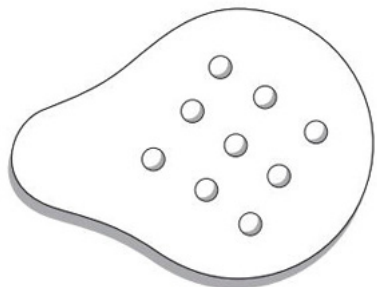
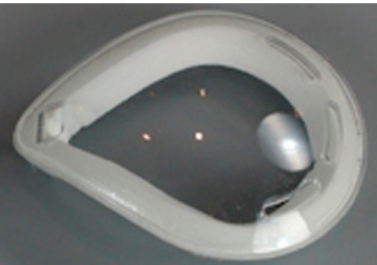
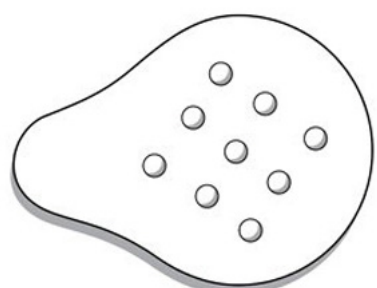

EYE SHIELDS

Item #	Description	Image
AXI4116	<p><b>Sterile Clear Eye Shield</b></p> <p>Clear sterile plastic vented shield, universal size with standard shell. Does not have guarder or padded lining. Sold 50 per box.</p>	
AXI5042	<p><b>Non-Sterile Clear Eye Shield</b></p> <p>Clear non-sterile plastic vented shield, universal size with standard shell. Does not have guarder or padded lining. Sold 100 per bag.</p>	
AXI5346	<p><b>Non-Sterile Clear Eye Shield</b></p> <p>Clear non-sterile polycarbonate vented shield, universal youth size with standard shell. Shield has foam lining but no guarder. Sold 25 per box.</p>	
AXI5723	<p><b>Sterile Clear Eye Shield</b></p> <p>Clear sterile plastic vented shield, universal 3" x 2.5" size with standard shell. Does not have guarder or padded lining. Sold 50 per box.</p>	



EYE SHIELDS

Item #	Description	Image
--------	-------------	-------

**Gray Eye Shield**

Gray tinted non-sterile polycarbonate vented shield, universal size with deep shell. Does not have guarder or padded lining. Sold 50 per box.

AXI5590 [Non-Sterile Gray Eye Shield](#)

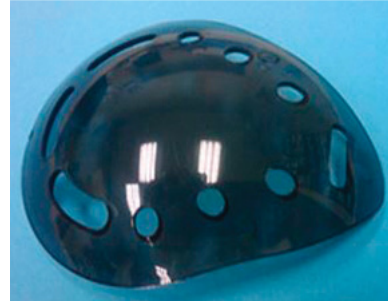

**Metal Eye Shield**

Aluminum non-sterile pinhole shield, universal size with standard shell. Shield has a white thermoplastic guarded edge that is latex-free. No padded lining. Sold 50 per box.

AXI0193 [Non-Sterile Metal Eye Shield](#)



IRIS RETRACTORS

Item #	Description	Image
--------	-------------	-------

**Disposable Iris Retractor**

Sterile, disposable iris retractors. Used to gently stretch and stabilize the iris for increased visibility during surgery. The iris retractor is held in place by an adjustable silicone circle. Sold in set of 5.

AXI4020 [Iris Retractor, Polypropylene](#)  
Polypropylene iris retractor.



IRIS RETRACTORS

Item #	Description	Image
AXI4139	<b>Iris Retractor, Nylon</b> Nylon iris retractor.	

**Reusable Iris Retractor**

Reusable, polypropylene iris retractors with autoclavable case. Used to gently stretch and stabilize the iris for increased visibility during surgery. The iris retractor is held in place by an adjustable silicone circle. Sold 6 per set and come in reusable autoclavable case.

AXI5156	<b>Iris Retractors with Case</b>	
---------	----------------------------------	--

LIQUID BANDAGES

Item #	Description	Image
<b>Histoacryl Topical Skin Adhesive</b>		
Histoacryl has been referenced in more than 1,200 publications world-wide and is one of the most used topical skin adhesives. This skin adhesive forms a strong bond that seals the wound quickly and inhibits the growth of bacteria. Aesculap Histoacryl Blue Topical Skin Adhesive liquid comes in a 0.5ml tube with a precision applicator tip that provides a precise controlled application. The active ingredient is n-butyl-2 cyanoacrylate.		

AXI4287	<b>0.5ml Skin Adhesive</b>	
---------	----------------------------	--

PVA PRODUCTS/WECK-CEL

Item #	Description	Image
--------	-------------	-------

**Corneal Light Shield**

Used to protect hinge and posterior side of corneal flap. Used to protect the retina from the operating microscope light. Sold 20 per box.

AXI0089	<p><b>Ultracell Corneal Light Shield</b></p> <p>Corneal light shield, 7mm (0.28"). Made from PVA material. Manufactured by Beaver-Visitec.</p>
AXII998	<p><b>Merocel Corneal Light Shield</b></p> <p>Corneal light shield, 8mm (0.3") diameter. Made from exclusive Merocel PVA material. The Merocel material is lint-free. Designed to provide the surgeon with a superior fiber-free product. Manufactured by Beaver-Visitec.</p>
AXI5553	<p><b>Corneal Light Shield</b></p> <p>Coreneal light sheild, 8mm diameter (0.3"). Lint-free PVA material that keeps cornea moist. Manufactured by Hurricane Medical.</p>



**Cellulose Eye Spear**

Made from highly absorbent, natural, cellulose material. Fast wicking action delivers quick absorption of blood and fluid from the surgical area. The flat tip provides precise application at the surgical incision. Light blue handle.

AXI0087	<p><b>Ultraspear Eye Spear</b></p> <p>100 count, 5 per pouch, 20 pouches per box.</p>
AXI0088	<p><b>Ultraspear Eye Spear</b></p> <p>200 count, 10 per pouch, 20 pouches per box.</p>



**PVA Eye Spear**

Various brand PVA eye spears made from highly absorbent Merocel polyvinyl acetal (PVA) material. Designed to benefit both the patient and surgeon, each device is absorbent and firm, allowing gentle manipulation of delicate tissues during LASIK and other corneal procedures. Triangle-shaped spearhead, set on a malleable, polypropylene handle. Latex-free.

AXI0085	<p><b>Accutome Eye Spear</b></p> <p>Blue handle. 100 count, 5 per pouch, 20 pouches per box.</p>
AXI0086	<p><b>Accutome Eye Spear</b></p> <p>Blue handle. 200 count, 10 per pouch, 20 pouches per box.</p>
AXI5430	<p><b>Keracel Eye Spear</b></p> <p>Red handle. 60 count, 3 per pouch, 20 pouches per box.</p>
AXI5429	<p><b>Merocel Eye Spear</b></p> <p>Blue handle. 50 count, 5 per pouch, 10 pouches per box.</p>
AXI5643	<p><b>Ultraspear Eye Spear</b></p> <p>Light blue handle. 100 count, 5 per pouch, 20 pouches per box.</p>
AXI5644	<p><b>Ultraspear Eye Spear</b></p> <p>Light blue handle. 200 count, 10 per pouch, 20 pouches per box.</p>



PVA PRODUCTS/WECK-CEL

Item #	Description	Image
--------	-------------	-------

**LASIK PVA Disk**

Round surgical PVA sponge disks for LASIK surgery. Various size disks on plastic handles. One sterile round per pack. Sold 20 packs per box.

AXI0516      **9mm LASIK Disk**  
Surgical rounds that measure 9mm in diameter.

AXI5118      **7mm LASIK Disk**  
Surgical rounds that measure 7mm in diameter.



**Ultracell Instrument Wipe**

This Ultracell PVA instrument wipe is used in the care and cleaning of surgical instruments. 2mm thick instrument wipe that measures 3 x 3 inches. Sold 20 per box.

AXI0092      **Instrument Wipe**



## SURGICAL GLOVES

Item #	Description	Image
--------	-------------	-------

**Derma Prene Ultra Surgical Gloves**

The Ansell Derma Prene Ultra surgical glove is powder-free and made from latex-free neoprene. It is a good choice for latex-sensitive (Type I) and chemical-sensitive (Type IV) health-care professionals and patients. The Derma Prene Ultra is dark green in color for instant identification as a natural rubber latex-free glove. The glove is typically 12 inches in length and has an enhanced, beaded cuff and SureFit Technology for extra coverage and protection on the forearm, and to maintain the glove's position on surgical gowns. Hand-specific, sterile, powder-free smooth surface. Straight cuffs, intended for single use. 11.9" long with 0.19mm fingertip thickness. Sold 50 pairs per box.

AXII265	<b>Derma Prene Gloves, Size 7</b> Size 7 Derma Prene Ultra neoprene surgical gloves.
AXII774	<b>Derma Prene Gloves, Size 7.5</b> Size 7.5 Derma Prene Ultra neoprene surgical gloves.

**Encore Acclaim Surgical Gloves**

The Encore Acclaim is Ansell's premier powder-free surgical glove made from natural rubber latex. The glove's thickness allows for a comfortable fit and excellent tactile sensitivity during surgical procedures in a single- or double-gloving environment. Its smooth finish provides worry-free instrument and suture control, and its low allergen levels help reduce the risk of latex sensitization in health-care workers and patients. Hand-specific, sterile, powder-free ivory gloves with smooth surface. Beaded cuffs, intended for single use, 11.5" long with 0.25mm fingertip thickness. Sold 50 pairs per box.

AXI0235	<b>Encore Gloves, Size 6.5</b> Size 6.5 Encore Acclaim latex surgical gloves.
AXII798	<b>Encore Gloves, Size 7</b> Size 7 Encore Acclaim latex surgical gloves.
AXII799	<b>Encore Gloves, Size 7.5</b> Size 7.5 Encore Acclaim latex surgical gloves.
AXI3009	<b>Encore Gloves, Size 8</b> Size 8 Encore Acclaim latex surgical gloves.



## SURGICAL GLOVES

Item #	Description	Image
--------	-------------	-------

**Encore Surgical Gloves**

Encore surgical gloves are powder-free and made from natural rubber latex. The gloves have a textured finish for superior grip and handling, and their low allergen levels help reduce the risk of latex sensitization in health-care workers and patients. Hand-specific, sterile, powder-free, ivory gloves with a fully textured surface. Each glove has beaded cuffs and is intended for single use. Size 6.5, 11.5" in length with a 0.23mm fingertip thickness. Manufactured by Ansell. Sold 50 pairs per box.

AX11369	<a href="#">Encore Gloves, Size 6.5</a>	
---------	---	--

**No Powder Surgical Gloves**

These latex gloves have a straight, reinforced cuff for extra coverage and protection on the forearm and a textured finish for superior grip and handling of instruments and sutures. Powder-free to help eliminate powder-related post-operative complications and sensitivity. Hand-specific, sterile, powder-free, ivory gloves with a fully textured surface. Each glove has straight cuffs and is intended for single use. 11.8" in length with a 0.23mm fingertip thickness. Manufactured by Ansell. Sold 50 pairs per box.

AX10981	<a href="#">No Powder Gloves, Size 6.5</a>	
---------	--	--

	Size 6.5 surgical gloves.	
--	---------------------------	--

AX10943	<a href="#">No Powder Gloves, Size 7</a>	
---------	--	--

	Size 7 surgical gloves.	
--	-------------------------	--

AX10918	<a href="#">No Powder Gloves, Size 7.5</a>	
---------	--	--

	Size 7.5 surgical gloves.	
--	---------------------------	--

AX10982	<a href="#">No Powder Gloves, Size 8</a>	
---------	--	--

	Size 8 surgical gloves.	
--	-------------------------	--

**Perry Performance Plus Micro-Thin Surgical Gloves**

Perry Performance Plus micro-thin latex surgical gloves. Hand-specific, sterile, powder-free, polymer coating, brown gloves with a textured surface. Each glove has straight cuffs and is intended for single use. 11.4" in length with a 0.19mm fingertip thickness. Manufactured by Mckesson. Sold 40 pairs per box.

AX11683	<a href="#">Surgical Gloves, Size 7</a>	
---------	---	--

	Size 7 micro-thin surgical gloves.	
--	------------------------------------	--

AX11881	<a href="#">Surgical Gloves, Size 8</a>	
---------	---	--

	Size 8 micro-thin surgical gloves.	
--	------------------------------------	--





SURGICAL GLOVES

Item #	Description	Image
--------	-------------	-------

**Perry Performance Plus Surgical Gloves**

Perry Performance Plus latex and neoprene surgical gloves. Various glove sizes that are hand-specific and intended for single use. Sterile. Manufactured by Mckesson. Sold 40 pairs per box.

AXI4092

**Surgical Gloves, Size 5.5**

Size 5.5 Perry Performance Plus latex surgical gloves. Powder-free, cream-colored gloves with a smooth surface. Each glove has beaded cuffs and is intended for single use. 11.5" in length with a 0.23mm fingertip thickness.



AXII830

**Surgical Gloves, Size 6**

Size 6 Perry Performance Plus latex surgical gloves. Powder-free, brown-colored gloves with a textured surface. Each glove has straight cuffs and is intended for single use. 11.4" in length with a 0.19mm fingertip thickness.



AXI4968

**Surgical Gloves, Size 6**

Size 6 Perry Performance Plus neoprene surgical gloves. Powder-free, dark green-colored gloves with a smooth surface. Each glove has beaded cuffs and is intended for single use. 12.2" in length with a 0.20mm fingertip thickness.







AXII68I

**Surgical Gloves, Size 6.5**





Size 6.5 Perry Performance Plus latex surgical gloves. Powder-free, brown-colored gloves with a fully textured surface. Each glove has straight cuffs and is intended for single use. 11.4" in length with a 0.19mm fingertip thickness.



SURGICAL GLOVES

Item #	Description	Image
AXI1715	<p><b>Surgical Gloves, Size 6.5</b></p> <p>Size 6.5 Perry Performance Plus latex surgical gloves. Powdered, cream-colored gloves with a smooth surface. Each glove has beaded cuffs and is intended for single use. 11.5" in length with a 0.23mm fingertip thickness.</p>	
AXI4964	<p><b>Surgical Gloves, Size 6.5</b></p> <p>Size 6.5 Perry Performance Plus neoprene surgical gloves. Powder-free, dark green-colored gloves with a smooth surface. Each glove has beaded cuffs and is intended for single use. 12.2" in length with a 0.20mm fingertip thickness.</p>	
AXI1684	<p><b>Surgical Gloves, Size 7</b></p> <p>Size 7 Perry Performance Plus latex surgical gloves. Powdered, cream-colored gloves with a smooth surface. Each glove has beaded cuffs and is intended for single use. 11.3" in length with a 0.23mm fingertip thickness.</p>	
AXI1688	<p><b>Surgical Gloves, Size 7</b></p> <p>Size 7 Perry Performance Plus latex surgical gloves. Powder-free, polymer coating, cream-colored gloves with a smooth surface. Each glove has beaded cuffs and is intended for single use. 11.5" in length with a 0.23mm fingertip thickness.</p>	

## SURGICAL GLOVES

Item #	Description	Image
AXI4965	<p><b>Surgical Gloves, Size 7</b></p> <p>Size 7 Perry Performance Plus neoprene surgical gloves. Powder-free, dark green-colored gloves with a smooth surface. Each glove has beaded cuffs and is intended for single use. 12.2" in length with a 0.20mm fingertip thickness.</p>	
AXII432	<p><b>Surgical Gloves, Size 7.5</b></p> <p>Size 7.5 Perry Performance Plus latex surgical gloves. Powdered, cream-colored gloves with a smooth surface. Each glove has beaded cuffs and is intended for single use. 11.3" in length with a 0.23mm fingertip thickness.</p>	
AXII626	<p><b>Surgical Gloves, Size 7.5</b></p> <p>Size 7.5 Perry Performance Plus latex surgical gloves. Powder-free, brown-colored gloves with a textured surface. Each glove has straight cuffs and is intended for single use. 11.4" in length with a 0.19mm fingertip thickness.</p>	
AXII646	<p><b>Surgical Gloves, Size 7.5</b></p> <p>Size 7.5 Perry Performance Plus latex surgical gloves. Powder-free, polymer-coated, cream-colored gloves with a smooth surface. Each glove has beaded cuffs and is intended for single use. 11.5" in length with a 0.23mm fingertip thickness.</p>	

SURGICAL GLOVES

Item #	Description	Image
AXI5112	<p><b>Surgical Gloves, Size 7.5</b></p> <p>Size 7.5 Perry Performance Plus neoprene surgical gloves. Powder-free, dark green-colored gloves with a smooth surface. Each glove has beaded cuffs and is intended for single use. 12.2" in length with a 0.20mm fingertip thickness.</p>	
AXI0957	<p><b>Surgical Gloves, Size 8</b></p> <p>Size 8 Perry Performance Plus latex surgical gloves. Powdered, cream-colored gloves with a smooth surface. Each glove has beaded cuffs and is intended for single use. 11.3" in length with a 0.23mm fingertip thickness.</p>	
AXI1649	<p><b>Surgical Gloves, Size 8</b></p> <p>Size 8 Perry Performance Plus latex surgical gloves. Powder-free, cream-colored gloves with a smooth surface. Each glove has beaded cuffs and is intended for single use. 11.5" in length with a 0.23mm fingertip thickness.</p>	
AXI1627	<p><b>Surgical Gloves, Size 8.5</b></p> <p>Size 8.5 Perry Performance Plus latex surgical gloves. Powder-free, brown-colored gloves with a fully textured surface. Each glove has straight cuffs and is intended for single use. 11.4" in length with a 0.19mm fingertip thickness.</p>	

SURGICAL GLOVES

Item #	Description	Image
AX11737	<p><b>Surgical Gloves, Size 8.5</b></p> <p>Size 8.5 Perry Performance Plus latex surgical gloves. Powder-free, cream-colored gloves with a smooth surface. Each glove has beaded cuffs and is intended for single use. 11.5" in length with a 0.23mm fingertip thickness.</p>	

**Sempermed Supreme Surgical Gloves**

Sempermed Supreme surgical gloves are anatomically designed to reduce hand fatigue and increase comfort. They are powder-free to eliminate aerosolization and skin irritation. A special multi-layer copolymer composition provides optimal protection during surgery. Hand-specific, sterile, powder-free, ivory-colored gloves with a micro-textured surface. Each glove has beaded cuffs and is intended for single use. 10.6" in length with a 0.27mm fingertip thickness. Manufactured by Sempermed USA. Sold 50 pairs per box.

AX15021	<p><b>Sempermed Gloves, Size 7.5</b></p>	
---------	--	---

**SensiCare Surgical Gloves**

SensiCare revolutionized the medical glove industry as the first latex-free synthetic polyisoprene surgical glove on the market. Medline is the only surgical glove manufacturer that makes its own raw material polyisoprene, called Isolex, ensuring you a safe, quality product. SensiCare is coated with 100% pure aloe vera to help soothe and moisturize dry, irritated skin caused by frequent handwashing and glove-wearing. Hand-specific, sterile, powder-free, white-colored gloves with a smooth surface coated in aloe and polymer. Each glove has beaded cuffs and is intended for single use. 12" in length with a 25mm fingertip thickness. Sold 25 pairs per box.

AX15155	<p><b>SensiCare Gloves, Size 6</b></p>	
	<p>Size 6 surgical gloves.</p>	
AX14889	<p><b>SensiCare Gloves, Size 7</b></p>	
	<p>Size 7 surgical gloves.</p>	
AX12048	<p><b>SensiCare Gloves, Size 7.5</b></p>	
	<p>Size 7.5 surgical gloves.</p>	
AX10852	<p><b>SensiCare Gloves, Size 8</b></p>	
	<p>Size 8 surgical gloves.</p>	



## SURGICAL GLOVES

Item #	Description	Image
--------	-------------	-------

**Sensi-Touch Surgical Gloves**

Ansell Sensi-Touch powdered surgical gloves with a straight, reinforced non-beaded cuff for extra coverage and protection on the forearm. The glove's latex formulation provides superior strength, and its design helps to reduce hand fatigue. Hand-specific, sterile, powdered, ivory-colored gloves with a smooth surface. Intended for single use. 12.9" in length with a 0.24mm fingertip thickness. Sold 50 pairs per box.

AXI1186	<b>Sensi-Touch Gloves, Size 6.5</b>	
---------	-------------------------------------	--

Size 6.5 surgical gloves.

AXI1315	<b>Sensi-Touch Gloves, Size 7</b>
---------	-----------------------------------

Size 7 surgical gloves.

AXI1316	<b>Sensi-Touch Gloves, Size 7.5</b>
---------	-------------------------------------

Size 7.5 surgical gloves.

AXI2024	<b>Sensi-Touch Gloves, Size 8.5</b>
---------	-------------------------------------

Size 8.5 surgical gloves.

**Original Perry Style 42 Surgical Gloves**

Ansell's Original Perry Style 42 powdered surgical gloves provide uncompromising quality and durability. Their satin-smooth finish provides maximum tactile sensitivity and is produced with advanced technology to lower powder and protein levels. This product contains natural rubber latex, which may cause allergic reactions. This latex glove contains 60 micrograms or less of total water-extractable protein per gram. Hand-specific, sterile, powdered, ivory-colored gloves with a smooth anti-slip surface. Each glove has beaded cuffs and is intended for single use. 11.7" in length with a 0.23mm fingertip thickness. Sold 50 pairs per box.

AXI0836	<b>Perry Gloves, Size 7</b>	
---------	-----------------------------	--

Size 7 surgical gloves.

AXI0870	<b>Perry Gloves, Size 7.5</b>
---------	-------------------------------

Size 7.5 surgical gloves.

AXI1069	<b>Perry Gloves, Size 8</b>
---------	-----------------------------

Size 8 surgical gloves.



**SURGICAL GLOVES**

Item #	Description	Image
--------	-------------	-------

**Triflex Surgical Gloves**

Triflex sterile surgical gloves have an anti-slip finish for a firm grip and mechanically locking cuffs that prevent rolldown. Extensive rinse cycles on the gloves reduces latex allergens and proteins. Hand-specific, sterile, powdered, ivory-colored gloves with a smooth surface. Each glove has beaded cuffs and is intended for single use. 12" in length with a 0.23mm fingertip thickness. Manufactured by Cardinal. Sold 40 pairs per box.

AXI1455 **Triflex Gloves, Size 7.5**  
Size 7.5 surgical gloves.

AXI0683 **Triflex Gloves, Size 8**  
Size 8 surgical gloves.



**Triumph Green Surgical Gloves**

AORN, the CDC, the American College of Surgeons, and the American Academy of Orthopedic Surgeons recommend double gloving during invasive procedures. Triumph Green latex powder-free surgical gloves are ideal when double gloving with Aloetouch Natural, Triumph, or Triumph LT. Made from low-protein natural rubber latex with synthetic polymer coating. Dark green-colored gloves with a smooth surface coated in aloe and polymer. Each glove has beaded cuffs and is intended for single use. 12" in length with a 8.5mm fingertip thickness. Manufactured by Medline. Sold 50 pairs per box.

AXI3975 **Triumph Gloves, Size 7**



**Triumph LT Surgical Gloves**

All of Medline's powder-free gloves have a proprietary inner polymer coating, which allows for easy donning and double gloving. The Triumph LT Sterile Latex Powder-Free Surgical Glove is a standard-thickness glove that can be used alone or as an outer glove when double gloving over Medline's Aloetouch Latex-Free Powder-Free Surgical Glove. The unique beaded cuff is reinforced to resist tearing. Sterile, white-colored gloves with a lightly textured surface coated with synthetic polymer donning agent. Each glove has beaded cuffs and is intended for single use. 12" in length with a 23mm fingertip thickness. Manufactured by Medline. Sold 50 pairs per box.

AXI0900 **Triumph Gloves, Size 7**



## SURGICAL LENSES

Item #	Description	Image
--------	-------------	-------

**Bi-Concave Disposable Lens**

Volk's disposable lenses deliver high-resolution, direct-image retinal views in a convenient sterile, single-use design. They are packaged individually in an easy-to-use peel pack. Sold 10 per pack.

AXI5229	<a href="#">Bi-Concave Disposable Lens</a>	
---------	--	--

**Flat Disposable Lens**

Volk's disposable lenses deliver high-resolution, direct-image retinal views in a convenient sterile, single-use design. They are packaged individually in an easy-to-use peel pack. Sold 10 per pack.

AXI4910	<a href="#">Flat Disposable Lens</a>	
---------	--------------------------------------	---

**Flat SSV Disposable Lens**

Primarily used for routine direct image vitreoretinal surgery of the central retina. Lens is Direct Image Flat (ACS) with a field of view of 30 degrees and an image magnification of 0.92x. Nonsterile, autoclavable. Sold individually.

AXI5012	<a href="#">Flat SSV Disposable Lens</a>	
---------	--	--



## SURGICAL LENSES

Item #	Description	Image
--------	-------------	-------

**Magnifying Disposable Lens**

Volk's disposable lenses deliver high-resolution, direct-image retinal views in a convenient sterile, single-use design. They are packaged individually in an easy-to-use peel pack. Sold 10 per pack.

AXI5044	<a href="#">Magnifying Disposable Lens</a>	
---------	--	--

**Wide Field Disposable Lens**

Volk's disposable lenses deliver high-resolution, direct-image retinal views in a convenient sterile, single-use design. They are packaged individually in an easy-to-use peel pack. Sold 10 per pack.

AXI5063	<a href="#">Wide Field</a>	
---------	----------------------------	--

**30-Degree Prism Disposable Lens**

Volk's disposable lenses deliver high-resolution, direct-image retinal views in a convenient sterile, single-use design. They are packaged individually in an easy-to-use peel pack. Sold 10 per pack.

AXI5230	<a href="#">30-Degree Prism Disposable Lens</a>	
---------	---	--



## SURGICAL LENSES

Item #	Description	Image
<b>30-Degree Prism SSV ACS Lens</b>	<p>Primarily used for off-axis direct image vitreoretinal surgery. Lens is direct-image, 30-degree Prism (ACS) with a field of view of 30 degrees offset, and an image magnification of 0.90x. Patented Chalam SSV design eliminates the need for sutures or rings. Nonsterile, autoclavable. Sold individually.</p>	
AXI5402	<b>30-Degree Prism Lens</b>	



# Instrument Covers



PROTECTORS & GUARDS

Item #	Description	Image
--------	-------------	-------

**Comply Instrument Protector**

3M Comply Instrument Protectors, protect sharp-pointed surgical instruments from damage and reduces possibility of pouch puncture during sterilization. It protects sharp surgical instruments from damage while holding them open for full sterilant contact. Dual indicators on the protector verify steam or EO processing. White instrument protector that measures 2 x 5 inches and is latex-free. Sold 100 per box.

AXI3932	<a href="#">White Instrument Protector</a>	
---------	--	--



**Osteotome Instrument Tip Guard**

Designed to protect osteotome instrument edges from chipping during sterilization, storage, and handling. Covers can reduce monthly repair or replacement costs by meeting protection needs. Clear, non-vented osteotome instrument tip protector. Measures 6.4mm x 19mm. Nonsterile and latex-free. Sold 50 per bag.

AXI0806	<a href="#">Clear Instrument Guard</a>	
---------	--	--



**Round Instrument Tip Guard**





Rounded tip guards designed to protect medical instruments from damage during sterilization, storage, and handling. Covers can reduce monthly repair or replacement costs by meeting protection needs. Blue-tinted, vented instrument tip protectors. Measures 38.1mm in length and fits 3mm to 4mm tips. Nonsterile and latex-free. Sold 70 per bag.

AXII288	<a href="#">Blue Instrument Guard</a>	
---------	---------------------------------------	--









PROTECTORS & GUARDS



Item #	Description	Image
<b>Standard Instrument Tip Guard</b>		
<p>Designed to protect medical instruments from damage during sterilization, storage, and handling. Covers can reduce monthly repair or replacement costs by meeting protection needs. Nonsterile and latex-free. Sold 100 per bag.</p>		
AXI0807	<p><b>Clear Instrument Guard</b> Clear, vented instrument tip protectors. Measures 2.8mm x 19mm.</p>	
AXI1208	<p><b>Clear Instrument Guard</b> Clear, vented instrument tip protectors. Measures 5mm x 25mm.</p>	
AXI2025	<p><b>Green Instrument Guard</b> Solid green, vented instrument tip protectors. Measures 2.8mm x 19mm.</p>	
AXI3238	<p><b>Clear Instrument Guard</b> Clear, nonvented instrument tip protectors. Measures 3.2mm x 25.4mm.</p>	

PROTECTORS & GUARDS

Item #	Description	Image
AXI5355	<p><b>Clear Instrument Guard</b></p> <p>Clear, vented instrument tip protectors. Measures 2mm x 9mm x 25mm.</p>	
AXI5468	<p><b>Assorted Instrument Guards</b></p> <p>Assorted colors, vented and solid instrument tip protectors. Various sizes.</p>	
AXI3979	<p><b>Orange Instrument Guard</b></p> <p>Orange-tinted, vented instrument tip protectors. Measures 2mm x 9mm x 25mm.</p>	
AXI5047	<p><b>Orange Instrument Guard</b></p> <p>Orange-tinted, nonvented instrument tip protectors. Measures 2mm x 9mm x 25mm.</p>	

# Cleaning & Sterilizing

DIAMOND KNIFE CLEANING SYSTEMS

Item #	Description	Image
<b>Opti-Kleen</b>		
<p>Accutome recommends the Opti-Kleen blade cleaning system for the care and cleaning of diamond knives. This is an efficient and safe method for cleaning tissue and other debris from the surfaces of diamond knife blades prior to sterilization. The Opti-Kleen blade cleaning system comes with 12 individual disposable trays per dispenser box. A holding tray with cover can also be purchased to cradle the cleaning system trays. The Opti-Kleen blade cleaning system can be used throughout the day for both diamond knives and delicate instruments. Each new instrument should be cleaned in an area of the pad that has not already been used.</p>		
AXII396	<p><b>Opti-Kleen Blade Cleaning System</b></p> <p>Each tray has three cleaning sections: a scrubbing section and two rinse sections. Sold 12 individual trays per box. Does not include plastic holder.</p>	
AXII397	<p><b>Opti-Kleen Holding Tray</b></p> <p>Plastic holder for disposable cleaning system trays.</p>	

INDICATOR STRIPS

Item #	Description	Image
<b>Biological Indicator Incubator</b>		
<p>3M Attest Incubator provides optimal incubation conditions for the accurate readout of 3M Attest biological indicators. Since the growth of each test organism is temperature dependent, it is critical that the appropriate Attest biological indicator be used with the correct Attest incubator. Biological indicator incubator, 14-vial (round), 56°C steam, 120 nominal voltage required, 90-132V acceptable.</p>		
AXI4154	<p><b>Biological Indicator Incubator</b></p>	

INDICATOR STRIPS

Item #	Description	Image
--------	-------------	-------

**Biological Indicator Test Pack**

Complete biological indicator test packs that includes everything needed for the monitoring of the steam sterilization process. For clinics, medical, and veterinary offices. The Centers for Disease Control and Prevention and AAMI recommend a weekly biological indicator challenge of all sterilizers. This is important to help prevent cross-contamination and to protect patients and medical professionals from infection that can result from a faulty sterilizer or its incorrect operation.

AXI2069

**Biological Test Pack and Culture Service Program**

Test results are uploaded daily to a secure online database and you will be provided a permanent record of test results. Spore testing is one of the most dependable methods to monitor sterilization. This is a complete system that includes a culture service program. Each box contains 10 test packs, 10 sterilization report forms, 10 pre-addressed postage paid envelopes and instructions for use. Takes 48 hours for culturing service. Sold 10 tests per box.



AXI5689

**Biological Indicator Test Pack**

The 3M Attest incubator provides optimal incubation conditions for the accurate readout of 3M Attest biological indicators. Biological indicator incubator, 14-vial (round), 56°C steam, 120 nominal voltage required, 90-132V acceptable. Kit includes: incubator, 1 roll tape, 1 box biological indicators, 1 bag chemical indicators, the log book, inservice video, and wall chart. Sterilization is indicated with color change and takes 48 hours for test results. Latex-free.



**Biological Indicator Vial**

Various brand biological indicators provide the best assurance of sterility by challenging the steam sterilizer with quantifiable, highly resistant *Geobacillus stearothermophilus* spores and providing results quickly. Biological indicators are used for load control monitoring, which is the process by which a load is monitored and released based on the result of a biological indicator (BI) in a test pack.

AXI3167

**3M Biological Indicator Vial**

The 3M Attest system provides results within 48 hours. The self-contained BI for 250°F/121°C gravity and 270°F /132°C vacuum-assisted steam cycles consist of a *Geobacillus stearothermophilus* spore strip, sealed glass ampule with growth medium and a bromocresol purple pH indicator system, brown color-coded cap with holes for sterilant penetration and a filter as a bacterial barrier, and a chemical indicator on the label that changes from rose to brown when processed. After sterilization, the vial is "crushed" to join the growth media with the processed spore strip. The BI is incubated for 48 hours for a visual color change readout. A color change to yellow indicates surviving spores and a positive result. Store at USP controlled room temperature. Sold 25 vials per box.





INDICATOR STRIPS

Item #	Description	Image
AXI4267	<p><b>3M Biological Indicator Vial</b></p> <p>The 3M Attest system provides results within 24 hours. 3M Attest I261 biological indicators for 270°F/132°C gravity steam cycles. Self-contained BI for 270°F/132°C gravity steam cycles consists of a <i>Geobacillus stearothermophilus</i> spore strip, sealed glass ampule with growth medium and a bromocresol purple pH indicator dye system, blue color-coded cap with holes for sterilant penetration and a filter as a bacterial barrier, and a chemical indicator on the label that changes from rose to brown when processed. After sterilization, the vial is "crushed" to join the growth media with the processed spore strip. The BI is incubated for 24 hours for a visual color change readout. A color change to yellow indicates surviving spores and a positive result. Store at USP controlled room temperature. Latex-free. Sold 100 per box.</p>	
AXI3258	<p><b>3M Biological Indicator Vial</b></p> <p>The 3M Attest system includes rapid readout biological indicators, disposable test packs, an auto-reader, and log books. 3M Attest I291 rapid readout biological indicators for 132°C/270°F gravity displacement cycles. Self-contained BI for gravity displacement cycles consisting of a <i>Geobacillus stearothermophilus</i> spore strip, sealed glass ampule with growth medium and dual indicator system, blue color-coded cap with holes for sterilant penetration and a filter as a bacterial barrier, and a chemical indicator on the label that changes from rose to brown when processed. After sterilization, the vial is "crushed" to join the growth media with the processed spore strip. The BI is incubated for 1 hour in the 3M Attest 290 series auto-reader for a fluorescent reading. Note: This product must be used with Cat. No. 290 3M Attest auto-reader. This product is latex-free. Sold 50 per box.</p>	
AXI4475	<p><b>Ster-All Biological Indicator Vial</b></p> <p>Ster-All Performance Self-Contained Steam BI is for use in monitoring 60-degree celsius steam sterilization processes. Final readout takes only 24 hours and fits in existing incubators. Latex-free. Sold 25 tests per box.</p>	
AXI4993	<p><b>Ster-All Biological Indicator Vial</b></p> <p>Ster-All Performance Self-Contained Steam BI is for use in monitoring 60-degree celsius steam sterilization processes. Final readout takes only 24 hours and fits in existing incubators. Latex-free. Sold 100 tests per box.</p>	



INDICATOR STRIPS

Item #	Description	Image
--------	-------------	-------

AXI5461

**ProSpore2 Biological Indicator Vial**

ProSpore2 is ideal for in-office validation and monitoring of steam sterilizers. It consists of a paper disk carrier containing *Geobacillus stearothermophilus* spores. The disk is enclosed in a plastic tube along with a glass vial containing media for growing the bacterial spores. Bromocresol purple has been added to assist in detecting spore growth. The outgrowth of spores decreases pH, causing a color change from purple to yellow. A shorter incubation period allows a validated 24-hour result. Includes biological indicators, testing incubator, record-keeping system, and vial crusher. Sold 50 per box.

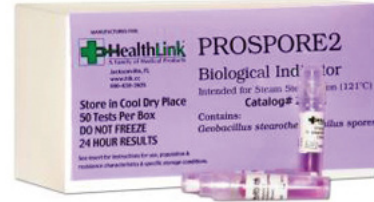

**Class 4 Steam Indicator Strip**

These class 4 steam indicator strips have a distinctive, color change feature when exposed to steam sterilization. Ranges in size and colors.

AXI0400

**Medline Sterilization Indicator Strip**

Class 4 steam indicator strip that measures 4”L x 1.25”W x 1.5”H and has a distinctive, non-reversible color change from blue to black. These strips contain latex, and are for use in gravity and vacuum cycles. Sold 250 per box.



AXI5672

**3M Steam Indicator Strip**

3M Comply class 4 steam indicator strip that measures 0.625”W x 4.25”L in short form, which is convenient for smaller packs. Has a distinctive color change from yellow to black and can be used in all steam sterilizers. These strips are latex-free and are for use as an internal pack monitor for 250-270°F processes. Sold 250 per box.



AXI3832

**3M Steam Indicator Strip**

3M Comply class 4 steam indicator strip that measures 0.625”W x 8”L and have a distinctive color change from off-yellow to black. It can be used in all steam sterilizers and is perforated, allowing for full- or half-length use for different pack sizes. These strips are latex-free and are for use as an internal pack monitor. Store at USP controlled room temperature. Sold 240 per box.



AXI4058

**Medline Steam Indicator Strip**

These measure the time, temperature, and presence of steam in steam sterilizers. They use a distinctive color change from purple to green and are made of laminated plastic. Measures 4” in length and are to be used for Cidex OPA tests. Latex-free. Sold 250 per box.



INDICATOR STRIPS

Item #	Description	Image
--------	-------------	-------

**Class 5 Steam Indicator Strip**

As an internal pack monitor, the 3M Comply (SteriGage) Class 5 Steam Chemical Integrators offer immediate, accurate and easy to read method of monitoring the sterilization process conditions inside each pack. It can be used in all steam sterilizers. The easy-to-read moving front style has been shown to have a higher reading accuracy than color interpretation style indicators. Use in steam sterilization cycles at 250°F, 270°F, 273°F, and 275°F. Measures 0.75"W x 2"L and are latex-free. Takes 15 minutes, depending on temperature.

AXI3038	<p><b>3M Steam Indicator Strip</b> Sold 100 per bag.</p>
---------	--

AXI4291	<p><b>3M Steam Indicator Strips</b> Sold 500 per bag.</p>
---------	---



**Dry Heat Sterilization Indicator Strip**

Dry heat indicator strip that measures 4" in length and are made from paper. Disposable, nonsterile, latex-free strips. Sold 100 per box.

AXI1042	<p><b>Dry Heat Indicator Strip</b></p>
---------	--



**Indicator Label**

Each chemical indicator label provides distinct color change when exposed to the sterilization process. Has date and operator fields on label. Pressure-sensitive indicator for use in dry-heat sterilization processes. Measures 0.75"W x 1.25"L. Sold 125 labels per roll.

AXI5245	<p><b>Indicator Label</b></p>
---------	-------------------------------

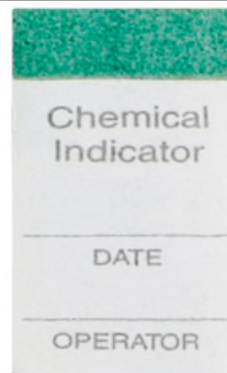

INDICATOR STRIPS

Item #	Description	Image
--------	-------------	-------

**OK Steam Sterilization Strip**

OK Steam Sterilization Strips are indicators that monitor all critical sterilization parameters: steam, time, and temperature. In sterilization cycles, OK strips guard against incomplete steam penetration, presence of non-condensing gases or excessive air, as well as from inadequate temperature or insufficient time exposure. The pre-printed standard reference color permits rapid and certain visualization of the results. If the sterilization conditions meet requirements, the arrow and the K will change to become at least as dark as the reference color "O" forming the OK expression. The indicator dot printed on the distal end of the 8" strip permits a secure sterile presentation. Only if this dot is dark may sterile personnel handle the strip and the package contents. Without such assurance, contamination of personnel becomes a real risk. For steam sterilization cycles of 250°F (121°C) and 272°F (134°C). Measures 0.56"W x 4"L. Sold 250 per box.

AXI3984 [OK Steam Sterilization Strips](#)



**Steam Indicator Tape**

Surgical instrument sterilization tape is used to seal sterilization packs or wraps. The tape will visually indicate that the pack has been exposed to the steam sterilization cycle by its distinctive, non-reversible color change from beige to black. Lead-free ink means no hazardous waste issues. The tape material has a stretchable backing that minimizes tape "pop-off" during sterilization. This tape can also be written on or labeled with pre-printed labels. Sold individually.

AXI3347 [0.94-Inch Steam Indicator Tape](#)  
 3M Comply lead-free steam indicator tape measures 0.94 inch x 60 yards.

AXI5487 [0.70-Inch Steam Indicator Tape](#)  
 3M Comply lead-free steam indicator tape measures 0.70 inch x 60 yards.

AXI5181 [1-Inch Steam Indicator Tape](#)  
 McKesson steam indicator tape measures 1 inch x 60 yards. Contains latex.

AXI1290 [1-Inch Steam Indicator Tape](#)  
 Medline steam indicator tape measures 1 inch x 60 yards. Contains latex.



STERILIZATION POUCHES

Item #	Description	Image
--------	-------------	-------

**Dry-Heat Sterilization Pouch**

Nylon packaging products are manufactured for use with dry heat processes up to 420°F. Nylon material is clear, strong and puncture resistant, maintaining a durable barrier for instrumentation until point of use. These self-seal nylon pouches feature built-in adhesive tape which eliminates the need for a heat sealer or indicator tape. Each pouch is notched for ease of opening after processing, and complimentary external chemical indicator labels are included. Sold 100 per box.

AXI4271	<b>2" Sterilization Pouch</b> 2" x 10" sterilization pouch.
AXI1038	<b>3" Sterilization Pouch</b> 3" x 10" sterilization pouch.
AXI1013	<b>4" Sterilization Pouch</b> 4" x 10" sterilization pouch.
AXI4457	<b>7" Sterilization Pouch</b> 7" x 10.5" sterilization pouch.
AXI5736	<b>9.5" Sterilization Pouch</b> 9.5" x 13" sterilization pouch.

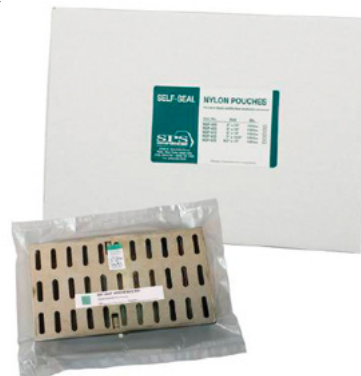

**Steam Sterilization Pouch**

Various sizes and brands of sterilization pouches. All pouches are transparent for easy viewing and are compatible for EO gas/steam sterilization. Sold 200 per box.

AXI1638	<b>3.5" Sterilization Pouch</b> 3.5" x 5.25" View Pack sterilization pouch. Patented triple seal provides an adhesive-to-adhesive, adhesive-to-paper, and adhesive-to-poly closure for a secure, tamper-free barrier. Triple rail seal offers protection exceeding that of one wide seal, resists blowouts, and provides uniform peel when opening. Blue-tinted laminate helps to quickly detect if a hole or tear is present. Highest quality medical grade paper helps prevent fiber tear of the packaging.
---------	--



AXI3288	<b>3.5" Sterilization Pouch</b> 3.5" x 5.25" Sure-Check sterilization pouch with built-in internal/external multi-parameter steam sterilization indicators confirm all sterilization criteria—time, temperature, and presence of steam. Eliminates the extra step of adding separate multi-parameter indicators to each pouch. Meets CDC infection control guidelines for effective sterilization.
---------	---



STERILIZATION POUCHES

Item #	Description	Image
AXI4229	<p><b>3.5" Sterilization Pouch</b></p> <p>3.5" x 8" Steriking sterilization pouch is transparent white in color. This self-sealing pouch is made from a paper/film material. Feature the innovative and convenient chemical indicator (Class I) peel-off strip. The sterilizable adhesive strip promotes a tight, impermeable closing of the pack, while the closing flap is prefolded to facilitate the sealing of the pouch.</p>	
AXI5752	<p><b>3.5" Sterilization Pouch</b></p> <p>3.5" x 9" Sure-Check sterilization pouch. This self-sealing pouch is made from a film material with built-in internal/external multi-parameter steam sterilization indicators to confirm all sterilization criteria—time, temperature, and presence of steam. Eliminates the extra step of adding separate multi-parameter indicators to each pouch and meets CDC infection control guidelines for effective sterilization.</p>	
AXI0413	<p><b>3.5" Sterilization Pouch</b></p> <p>3.5" x 9" Ster-All sterilization pouch is made from a blue paper/film material. Thumb notch at the fold makes it easy to open and grip. Perforated edge helps to ensure a quality seal. Made of a polypropylene/polyester blend and medical grade paper. Latex-free.</p>	
AXI4487	<p><b>3.5" Sterilization Pouch</b></p> <p>3.5" x 9" Medline sterilization pouch. Transparent blue and self-sealing.</p>	



STERILIZATION POUCHES

Item #	Description	Image
AXI5809	<p><b>3.5" Sterilization Pouch</b></p> <p>3.5" x 9" View Pack sterilization pouch. Transparent blue and self-sealing. Patented triple seal provides an adhesive-to-adhesive, adhesive-to-paper, and adhesive-to-poly closure for a secure, tamper-free barrier. Triple rail seal offers protection exceeding that of one wide seal, resists blowouts, and provides uniform peel when opening. Blue-tinted laminate helps to quickly detect if a hole or tear is present, and highest quality medical grade paper helps prevent fiber tear of the packaging.</p>	
AXI0155	<p><b>5.25" Sterilization Pouch</b></p> <p>5.25" x 10" Ster-All self-seal sterilization pouch is transparent blue in color. This self-sealing pouch is made from a paper/film material and contains a thumb notch at the fold, making it easy to open and grip. Perforated edge helps to ensure a quality seal. Made of a polypropylene/polyester blend and medical grade paper. Latex-free.</p>	
AXI0545	<p><b>7.5" Sterilization Pouch</b></p> <p>7.5" x 13" McKesson Argent Sure-Check self-seal sterilization pouch is transparent blue. This self-sealing pouch is made from a paper/film material and helps to ensure infection prevention through proper instrument sterilization, facilitating the safety of both patients and medical staff. Triple seals trap heat along the secured edges to prevent separation. Sterilization pouches maintain sterilization integrity through extra-wide chevron seals. Includes Class 4 or Multi-Parameter Sterilization indicators to help ensure proper saturating steam presence, exposure time, and sufficient high temperatures. Wide self-seal strip and thumb notch make it easy to open. Medical-grade paper eases the labeling process; clear transparent film provides aseptic presentation and easy identification of surgical equipment.</p>	
AXI4173	<p><b>12" Sterilization Pouch</b></p> <p>12" x 18" McKesson Argent Sure-Check self-seal sterilization pouch is transparent blue. This self-sealing pouch is made from a paper/film material and helps to ensure infection prevention through proper instrument sterilization, facilitating the safety of both patients and medical staff. Triple seals trap heat along the secured edges to prevent separation. Sterilization pouches maintain sterilization integrity through extra-wide chevron seals. Includes Class 4 or Multi-Parameter Sterilization indicators to help ensure proper saturating steam presence, exposure time, and sufficient high temperatures. Wide self-seal strip and thumb notch make it easy to open. Medical-grade paper eases the labeling process; clear transparent film provides aseptic presentation and easy identification of surgical equipment.</p>	



ULTRASONIC CLEANERS

Item #	Description	Image
--------	-------------	-------

**Crest 0.75-Gallon Ultrasonic Cleaner**

Crest medical grade 0.75-gallon tank capacity with analog timer and adjustable thermostatically controlled heater. A cover, main on/off switch, and drain valve are all included. All stainless steel enclosures resist chemical spills and will not crack. Has ceramically enhanced transducers and all timers have continuous operation. Dimensions of inside tank: 9.5”L x 5.25”W x 4”H; Overall Dimensions of unit: 11.5”L x 6.375”W x 9.25”H.

AM0940      [0.75-Gallon Ultrasonic Cleaner](#)



**Crest 2.5-Gallon Ultrasonic Cleaner**

Crest 2.5-gallon tank capacity with analog timer and adjustable thermostatically controlled heater. A cover, main on/off switch, and drain valve are all included. Has a sweep frequency of 45 kHz and all stainless steel enclosures resist chemical spills and will not crack. Has ceramically enhanced transducers and all timers have continuous operation. Dimensions of inside tank: 19.5”L x 5.25”W x 6”H; Overall Dimensions of unit: 20.25”L x 6”W x 10.625”H.

AM0970      [2.5-Gallon Ultrasonic Cleaner](#)



**Crest 5-Gallon Ultrasonic Cleaner**

Crest 5-gallon tank capacity with analog timer and adjustable thermostatically controlled heater. A cover, main on/off switch, and drain valve are all included. Has a sweep frequency of 45 kHz and all stainless steel enclosures resist chemical spills and will not crack. Has ceramically enhanced transducers and all timers have continuous operation. Dimensions of inside tank: 19.5”L x 11.75”W x 6”H; Overall Dimensions of unit: 21”L x 12.75”W x 14.5”H.

AM0975      [5-Gallon Ultrasonic Cleaner](#)



QUICKRINSE INSTRUMENT RINSE SYSTEM

Item #	Description	Image
--------	-------------	-------

**QuickRinse Cleaning System**

The QuickRinse instrument rinse system uses pressurized water and air to rinse lumened instruments and tubing, such as phaco handpieces, vitrectomy cutters, and I/A tubing. Unlike with a syringe, the compact system provides consistent rinsing pressure regardless of the operator. The QuickRinse also eliminates hand fatigue associated with repetitive syringe use. Complete system comes with: operator's manual, console, complete bottle assembly, nose cone rinse attachment, dual rinse "Y" attachment, power cord, power supply, accessory fittings, nylon brush, spare bottle cap gaskets, and spare quick-disconnect O-rings.

AM7550      [QuickRinse Cleaning System](#)



# Cryo Units



## CRYO UNITS

Item #	Description	Image
--------	-------------	-------

<b>Keeler Cryomatic Cryo Unit</b>		
-----------------------------------	--	--

With exceptional reliability, the Cryomatic delivers quality and versatility when using either disposable or reusable probes. The integral software automatically detects the type of probe in use and adjusts the unit accordingly, meaning the unit is ready for use in a matter of minutes. This technology ensures a short purge cycle time after time without the need for an adaptor. Engineered to produce greater reliability and freezing characteristics. Weighs 6 pounds and measures 12"W x 8"D x 7.5"H.

AM9050	<b>Keeler Cryomatic Cryo Unit</b>	
--------	-----------------------------------	--



# Pharmaceutical & Diagnostics



## 4Sight®

Item No. 24-8000

Ophthalmic ultrasound platform that combines the A-Scan, B-Scan, UBM, and Pachymeter in one easy-to-use platform.

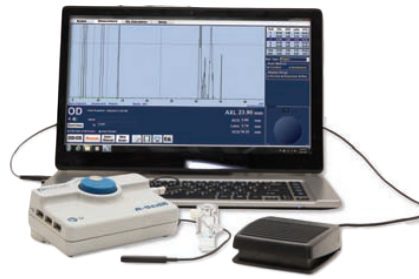

## A-Scan Plus Connect®

Item No. 24-4400

Portable design and an effective solution for measuring and calculating all of your patients, including dense cataracts, and refining your surgical outcomes.

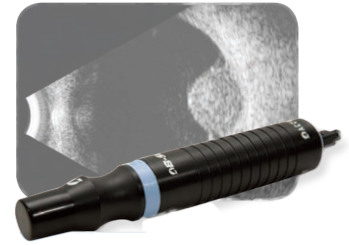

## B-Scan Plus®

Item No. 24-6100

Portable probe that provides HD imaging and assessment of the posterior segment, while a user-friendly interface can store and share information easily.



## AccuPen®

Item No. 24-3000

Gravity Offset Technology requires less calibration in any testing position while providing up to 9 accurate IOP measurements that can be stored.

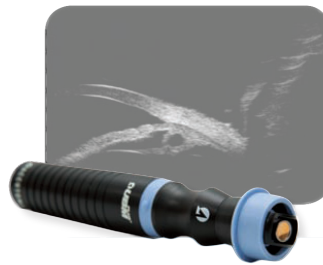

## UBM Plus®

Item No. 24-6300

Portable probe that provides HD imaging and assessment of the anterior segment, while a user-friendly interface can store and share information easily.



## Pachymeters®

Item No. 24-6200 & No. 24-5100

Accurate and easy-to-use portable or tabletop pachymeter versions that convert IOP measurements in seconds.



## Diagnostic Supplies

- Mydriatics/Cycloplegics
- Anesthetics
- Irrigating Solutions
- Gonioscopy
- Tonometry



## Therapeutics

- Miotic/Glaucoma Agents
- Antibiotics
- Anti-Inflammatories
- Antibiotic/Anti-Inflammatory Combo



## General Ophthalmic Supplies

- Eye Patches
- Punctum Plugs
- Needles and Syringes
- And Many More!



# PRODUCT NUMBER LOOKUP

AB-0550S.....	262	AB-2490.....	276	AB-3855.....	282
AB-1000.....	262	AB-2801.....	280	AB-3855S.....	282
AB-1000S.....	262	AB-2804.....	281	AB-3856.....	282
AB-1001.....	263	AB-2805.....	280	AB-3856S.....	282
AB-1052S.....	263	AB-2806.....	270	AB-3857.....	284
AB-1053S.....	265	AB-2807.....	270	AB-4300.....	283
AB-1401.....	263	AB-2808.....	269	AB-4302S.....	283
AB-1401S.....	263	AB-2808S.....	269	AB-4350S.....	282
AB-1402.....	266	AB-2853.....	280	AB-4351.....	283
AB-1403.....	262	AB-2854.....	269	AB-4351S.....	283
AB-1404.....	263	AB-2855.....	268	AB-4352.....	274
AB-1404S.....	263	AB-2856.....	271	AB-4353.....	273
AB-1405.....	265	AB-2859.....	270	AB-4355.....	273
AB-1406.....	263	AB-2860S.....	279	AB-4356.....	274
AB-1406S.....	264	AB-2863.....	272	AB-4357.....	274
AB-1407.....	265	AB-2865.....	271	AB-4359.....	283
AB-1407S.....	266	AB-2890.....	276	AB-4359S.....	283
AB-1410.....	264	AB-3305.....	280	AB-4360.....	284
AB-1410S.....	264	AB-3305S.....	280	AB-5351.....	283
AB-1411.....	271	AB-3353.....	281	AB-8102.....	276
AB-1412.....	272	AB-3354S.....	280	AB-8109.....	275
AB-1421.....	266	AB-3355.....	281	AB-8111.....	276
AB-1452.....	264	AB-3355S.....	281	AB-8112.....	275
AB-1457.....	268	AB-3356.....	280	AB-8117.....	277
AB-1459.....	264	AB-3358S.....	281	AB-8123.....	277
AB-1467.....	278	AB-3361.....	268	AB-8126.....	276
AB-1468S.....	264	AB-3361S.....	268	AB-8127.....	277
AB-1474.....	264	AB-3362S.....	270	AB-8137.....	274
AB-1475.....	265	AB-3363S.....	269	AB-8138.....	277
AB-1476.....	262	AB-3364.....	268	AB-8697G.....	278
AB-1478S.....	262	AB-3364S.....	268	AB-9105B.....	164
AB-1482.....	264	AB-3365.....	267	AB-9110.....	165
AB-2000.....	265	AB-3366.....	281	AB-9110B.....	164
AB-2002.....	265	AB-3370.....	272	AB-9115.....	164
AB-2002S.....	265	AB-3371.....	272	AB-9120.....	165
AB-2003.....	266	AB-3372.....	272	AB-9125P.....	164
AB-2003S.....	266	AB-3373.....	273	AB-9130.....	165
AB-2008.....	279	AB-3374.....	273	AB-9135.....	165
AB-2008S.....	279	AB-3375.....	273	AB-9155P.....	164
AB-2017.....	271	AB-3376.....	272	AB-9160P.....	164
AB-2023.....	278	AB-3377.....	272	AB-9170P.....	164
AB-2023S.....	278	AB-3378.....	273	AB-9175P.....	164
AB-2028.....	266	AB-3379S.....	269	AB-60600.....	256
AB-2054.....	266	AB-3380.....	273	AB-60625.....	256
AB-2056.....	267	AB-3381S.....	270	AB-60650.....	256
AB-2058.....	267	AB-3382.....	269	AB-60675.....	256
AB-2062S.....	279	AB-3382S.....	269	AB-60700.....	256
AB-2063.....	279	AB-3383S.....	271	AB-60725.....	256
AB-2068S.....	279	AB-3386.....	270	AB-60750.....	256
AB-2090.....	275	AB-3391.....	277	AB-60775.....	257
AB-2091.....	276	AB-3801.....	282	AB-60785.....	257
AB-2092.....	276	AB-3801S.....	282	AB-60800.....	257
AB-2455S.....	267	AB-3850S.....	281	AB-60825.....	257
AB-2457S.....	267	AB-3851.....	283	AB-60850.....	257
AB-2461.....	267	AB-3853S.....	270	AB-60875.....	257
AB-2461S.....	267	AB-3854.....	271	AB-60900.....	257
AB-2463.....	268	AB-3854S.....	271	AB-60925.....	257



# PRODUCT NUMBER LOOKUP

AB-60950.....	257	AB-AST15G.....	15	AC0231 27.....	80
AB-67600.....	256	AB-AST22.....	13	AC0320 5.....	77
AB-67650.....	256	AB-AST22G.....	15	AC0320 7.....	77
AB-67700.....	256	AB-AST30.....	13	AC0320 8.....	77
AB-67725.....	256	AB-AST45.....	13	AC0320 10.....	77
AB-67750.....	256	AB-AVR10.....	13	AC0350.....	86
AB-67775.....	256	AB-AVR10AG.....	15	AC0390.....	84
AB-67800.....	256	AB-AVR10S.....	13	AC0400.....	85
AB-67825.....	256	AB-AVR12.....	13	AC0457.....	82
AB-67850.....	256	AB-AVR19.....	13	AC0458.....	83
AB-67875.....	256	AB-AVR19A.....	13	AC0459.....	82
AB-67900.....	256	AB-AVR19AG.....	15	AC0460.....	81
AB-ACD26.....	14	AB-AVR19G.....	15	AC0460 23.....	81
AB-ACS20.....	14	AB-AVR20.....	13	AC0461.....	82
AB-ACU26.....	14	AB-AVR20A.....	13	AC0462.....	82
AB-ACU26G.....	16	AB-AVR20AG.....	16	AC0463.....	82
AB-ALRI500G.....	16	AB-AVR20G.....	15	AC0465.....	81
AB-ALRI550G.....	16	AB-AVR21AG.....	16	AC0466.....	83
AB-ALRI600G.....	16	AB-AVR21G.....	16	AC0467.....	82
AB-ARS32.....	14	AB-AVR23A.....	13	AC0469.....	82
AB-ARS35.....	14	AB-AVR23AG.....	16	AC0473.....	83
AB-ARS41.....	14	AB-AVR23G.....	16	AC0475.....	83
AB-ARS52.....	14	AB-AVR25.....	13	AC0476.....	83
AB-ASL10.....	12	AB-AVR25AG.....	16	AC0478.....	83
AB-ASL12.....	12	AB-AVR25G.....	16	AC0485.....	82
AB-ASL18.....	12	AC0105.....	76	AC0560.....	86
AB-ASL18DB.....	12	AC0110.....	76	AC0560 27.....	87
AB-ASL20.....	12	AC0120.....	77	AC0561.....	87
AB-ASL22.....	12	AC0121.....	77	AC0565.....	87
AB-ASL22DB.....	12	AC0122.....	76	AC0566.....	87
AB-ASL22G.....	15	AC0125.....	76	AC0567.....	87
AB-ASL23.....	12	AC0130.....	77	AC0570.....	86
AB-ASL24.....	12	AC0131.....	77	AC0580.....	87
AB-ASL24DB.....	12	AC0140.....	77	AC0582.....	87
AB-ASL24DBG.....	15	AC0141.....	77	AC0583.....	87
AB-ASL24G.....	15	AC0145.....	76	AC0584.....	86
AB-ASL25.....	12	AC0160.....	84	AC0590.....	86
AB-ASL25DB.....	12	AC0190 19.....	76	AC0620.....	78
AB-ASL25G.....	15	AC0190 20.....	76	AC0630.....	78
AB-ASL26.....	12	AC0190 23.....	76	AC0640.....	78
AB-ASL26DB.....	12	AC0190 25.....	76	AC0665.....	84
AB-ASL26G.....	15	AC0190 27.....	76	AC0666.....	84
AB-ASL27.....	12	AC0200.....	87	AC0675.....	84
AB-ASL27DB.....	12	AC0201.....	87	AC0740.....	78
AB-ASL27G.....	15	AC0220.....	80	AC0750.....	78
AB-ASL28.....	12	AC0230 A.....	80	AC0760.....	78
AB-ASL28DB.....	12	AC0230 18.....	79	AC0800.....	79
AB-ASL28G.....	15	AC0230 19.....	79	AC0810.....	79
AB-ASL30.....	13	AC0230 19 CS.....	81	AC0820.....	79
AB-ASL30DB.....	13	AC0230 21.....	79	AC1030 13.....	84
AB-ASL30G.....	15	AC0230 23.....	80	AC1030 21.....	84
AB-ASL32.....	13	AC0230 23 CS.....	81	AC1030 25.....	84
AB-ASL32DB.....	13	AC0230 25.....	80	AC1040.....	88
AB-ASL32G.....	15	AC0230 25 CS.....	81	AC1300.....	85
AB-ASL35.....	13	AC0230 26.....	80	AC1301.....	85
AB-ASL285.....	12	AC0230 27.....	80	AC1305.....	85
AB-AST15.....	13	AC0231 19.....	79	AC2110.....	86

# PRODUCT NUMBER LOOKUP

AC2120.....	86	AF0160.....	36	AF1185.....	138
AC2130.....	86	AF0162.....	36	AF1190.....	138
AC2140.....	86	AF0210.....	130	AF1240.....	138
AC2155.....	85	AF0215.....	130	AF1250.....	138
AC2262.....	84	AF0230.....	130	AF1270.....	138
AC2263.....	84	AF0250.....	130	AF1280.....	139
AC4174.....	81	AF0285T.....	139	AF1290.....	139
AC4175.....	81	AF0286.....	139	AF1290TI.....	139
AC5120.....	167	AF0288.....	131	AF1295.....	139
AC5120T.....	168	AF0290.....	132	AF1400.....	155
AC5140.....	168	AF0290 A.....	132	AF1403.....	155
AC5140T.....	168	AF0290K.....	132	AF2100.....	140
AC5141T.....	168	AF0290K T.....	133	AF2105.....	155
AC5150.....	168	AF0290L.....	134	AF2110.....	140
AC5150T.....	169	AF0290M.....	134	AF2120.....	140
AC5151.....	169	AF0290M T.....	134	AF2130.....	140
AC5151T.....	169	AF0290TI.....	133	AF2140.....	140
AC5160.....	169	AF0291.....	140	AF2150.....	141
AC5160T.....	169	AF0292.....	131	AF2320.....	141
AC5170.....	170	AF0295.....	131	AF2360.....	142
AC5170T.....	170	AF0299.....	133	AF2370.....	142
AC5180.....	170	AF0300.....	133	AF2380.....	142
AC5180T.....	170	AF0300 C.....	131	AF2395.....	142
AC5215.....	168	AF0300TI.....	133	AF2400.....	142
AC5220.....	169	AF0310.....	133	AF2405.....	145
AC5220T.....	170	AF0310TI.....	133	AF2440.....	142
AC5235.....	168	AF0340.....	132	AF2450.....	143
AC5235T.....	168	AF0350.....	133	AF2451.....	143
AC5245.....	169	AF0355.....	132	AF2510.....	154
AC5245T.....	169	AF0365T.....	131	AF2520.....	154
AC5400.....	88	AF0400.....	134	AF2540.....	143
AC6540.....	85	AF0410.....	134	AF3145TI.....	150
AC7000.....	166	AF0411.....	134	AF3150.....	145
AC7010.....	166	AF0430.....	134	AF3175.....	150
AC7030.....	165	AF0440.....	135	AF3177TI.....	151
AC7032.....	165	AF0450.....	135	AF3225.....	146
AC7040.....	166	AF0460.....	135	AF3230.....	146
AC7050.....	166	AF0470.....	135	AF3240.....	146
AC7100.....	165	AF0520.....	135	AF3305.....	145
AC7110.....	166	AF0530.....	132	AF3345.....	146
AC7120.....	167	AF0600.....	143	AF3355TI.....	149
AC7130.....	166	AF0700.....	144	AF3360.....	147
AC7430.....	166	AF0750.....	144	AF3370.....	147
AC7431.....	166	AF0800.....	136	AF3390.....	146
AC7450.....	167	AF0801.....	136	AF3480.....	145
AC7451.....	167	AF0810.....	136	AF3540.....	161
AC7530.....	167	AF0820.....	136	AF3600.....	149
AC8000.....	167	AF0830.....	136	AF3700.....	147
AF0100.....	37	AF0840.....	137	AF3705.....	147
AF0120.....	37	AF1110.....	137	AF3710.....	147
AF0120 IN.....	37	AF1110T.....	137	AF3720.....	147
AF0125.....	36	AF1115.....	141	AF3730.....	148
AF0127.....	36	AF1150.....	137	AF3740.....	148
AF0130.....	37	AF1160.....	137	AF3750.....	148
AF0130 I.....	37	AF1170.....	137	AF3760.....	148
AF0140.....	37	AF1180.....	139	AF3765.....	148
AF0145 A.....	38	AF1180TI.....	139	AF3775.....	148

# PRODUCT NUMBER LOOKUP

AF4100.....	143	AF6420TI.....	159	AH0620.....	120
AF4110.....	143	AF6421.....	159	AH0630.....	117
AF4120.....	144	AF6424.....	159	AH0630T.....	117
AF4130.....	144	AF6430.....	159	AH0630TI.....	117
AF4310.....	149	AF6450.....	159	AH0640.....	117
AF4320.....	149	AF6455.....	156	AH0650.....	118
AF4400.....	149	AF6470.....	160	AH0660.....	118
AF5100.....	151	AF6530.....	160	AH0670.....	118
AF5110.....	151	AF6580.....	157	AH0675T.....	118
AF5110TI.....	151	AF6700.....	161	AH0680.....	100
AF5140.....	152	AF6710.....	161	AH0690.....	101
AF5150.....	152	AF6720.....	161	AH0695T.....	100
AF5160.....	152	AF6730.....	161	AH0710.....	102
AF5170.....	152	AF6760.....	161	AH0730.....	102
AF5170TI.....	152	AF6770.....	162	AH0740.....	103
AF5180.....	152	AF6780.....	162	AH0750.....	119
AF5180K.....	153	AF6900.....	162	AH0760.....	119
AF5180TI.....	153	AF6910.....	162	AH0770.....	119
AF5190.....	153	AF6920.....	162	AH0780.....	119
AF5200.....	152	AF6930.....	161	AH0790.....	119
AF5200TI.....	152	AF6950.....	142	AH0800.....	120
AF5210.....	153	AF7600.....	150	AH0810.....	121
AF5220.....	153	AF7610.....	150	AH0820.....	121
AF5225.....	153	AF7635.....	150	AH0860.....	99
AF5240.....	154	AF7640TI.....	150	AH0870 C.....	99
AF5270.....	154	AF8000.....	145	AH0880.....	108
AF5290.....	154	AF9050TI.....	149	AH0890.....	108
AF5300.....	151	AF9075.....	144	AH0905.....	114
AF6100.....	155	AH0130.....	90	AH1000.....	234
AF6101.....	155	AH0140.....	94	AH1100.....	114
AF6110.....	155	AH0150.....	94	AH1110.....	104
AF6130.....	156	AH0160.....	94	AH1130.....	116
AF6135.....	155	AH0170.....	94	AH1140.....	99
AF6136.....	155	AH0180.....	94	AH1150.....	103
AF6137.....	155	AH0190.....	94	AH1155.....	103
AF6140.....	156	AH0200.....	94	AH1160.....	103
AF6178.....	141	AH0210.....	94	AH1165.....	103
AF6300.....	156	AH0220.....	90	AH1170.....	104
AF6300TI.....	156	AH0222.....	91	AH1175.....	104
AF6330.....	156	AH0225.....	90	AH1180.....	119
AF6350.....	160	AH0226.....	91	AH1190.....	104
AF6350TI.....	160	AH0228.....	90	AH1190TI.....	104
AF6351.....	157	AH0240.....	90	AH1200.....	104
AF6355.....	160	AH0260.....	198	AH1210.....	104
AF6355T.....	160	AH0300.....	199	AH1510.....	98
AF6360.....	157	AH0305.....	81	AH1520.....	98
AF6370.....	157	AH0510.....	127	AH1530.....	99
AF6380.....	157	AH0520.....	128	AH1530T.....	99
AF6395.....	130	AH0530.....	115	AH1540.....	99
AF6400.....	158	AH0540.....	115	AH1540T.....	99
AF6400 S.....	158	AH0550.....	97	AH1550.....	100
AF6400TI.....	158	AH0560.....	97	AH1560.....	101
AF6404.....	158	AH0580.....	115	AH1570.....	101
AF6410.....	158	AH0590.....	120	AH1580.....	96
AF6410S.....	158	AH0600.....	117	AH1600.....	115
AF6410TI.....	158	AH0605.....	115	AH2100.....	114
AF6420.....	159	AH0610.....	120	AH2110.....	114

# PRODUCT NUMBER LOOKUP

AH2120.....	115	AH4182.....	109	AH5255.....	235
AH2130.....	116	AH4184.....	110	AH5256.....	235
AH2135.....	102	AH4184TI.....	110	AH5260.....	234
AH2140.....	116	AH4185T.....	110	AH5265.....	235
AH2150.....	116	AH4190.....	103	AH5267.....	235
AH2160.....	116	AH4195.....	108	AH5270.....	235
AH2190.....	118	AH4200.....	104	AH5275.....	233
AH2210.....	122	AH4205.....	106	AH5290.....	204
AH2230.....	118	AH4205T.....	106	AH5310.....	204
AH2240.....	120	AH4210.....	107	AH5355.....	235
AH2505.....	172	AH4215.....	107	AH5360.....	120
AH2506.....	172	AH4216.....	107	AH5370.....	231
AH2510.....	172	AH4218.....	112	AH5380.....	98
AH2515.....	172	AH4220.....	101	AH5385.....	98
AH2540.....	174	AH4236.....	107	AH5390.....	236
AH2580.....	174	AH4240.....	109	AH5500.....	234
AH2595.....	174	AH4240TI.....	109	AH6110.....	250
AH3110.....	182	AH4242.....	109	AH6120.....	250
AH3130.....	182	AH4242T.....	109	AH6130.....	250
AH3150.....	182	AH4243.....	109	AH6140.....	236
AH3160.....	117	AH4265.....	110	AH6150.....	250
AH3170.....	182	AH4275.....	112	AH6500.....	197
AH3180.....	183	AH4282.....	96	AH6510.....	198
AH3190.....	183	AH4288.....	106	AH6520.....	198
AH3200.....	182	AH4289.....	106	AH6530.....	198
AH3210.....	183	AH4290.....	106	AH6545.....	106
AH3215.....	108	AH4290T.....	106	AH6610.....	232
AH3220.....	183	AH4295.....	106	AH6950.....	119
AH3230.....	183	AH4300.....	101	AH7100T.....	105
AH4100.....	96	AH4345.....	110	AH7101.....	105
AH4100T.....	96	AH4346.....	110	AH7105T.....	105
AH4110.....	96	AH4375.....	109	AH7106T.....	105
AH4115.....	107	AH4376.....	109	AH7107T.....	105
AH4120.....	97	AH4380.....	108	AH7110.....	105
AH4121.....	97	AH4381.....	108	AH7115.....	108
AH4122.....	97	AH4385T.....	109	AH7120.....	114
AH4125.....	97	AH4400.....	110	AH7125.....	100
AH4126.....	112	AH4450.....	96	AH7130.....	107
AH4126T.....	112	AH4600.....	232	AH7200.....	124
AH4135.....	100	AH4605.....	231	AH7201.....	231
AH4140.....	98	AH4606.....	231	AH7202.....	124
AH4140TI.....	98	AH4620.....	232	AH7210.....	91
AH4145.....	108	AH5100.....	230	AH7220.....	124
AH4160.....	102	AH5110.....	233	AH8150.....	232
AH4161.....	102	AH5120.....	230	AK0001L.....	32
AH4170.....	111	AH5124.....	236	AK0002L.....	32
AH4170TI.....	111	AH5125.....	236	AK0003L.....	32
AH4171T.....	110	AH5130.....	230	AK0009.....	33
AH4172T.....	110	AH5140.....	230	AK0010.....	33
AH4173.....	106	AH5150.....	230	AK0011L.....	32
AH4175.....	111	AH5160.....	230	AK0012L.....	32
AH4176.....	111	AH5170.....	233	AK0013L.....	32
AH4177.....	111	AH5190.....	234	AK0018L.....	32
AH4178.....	111	AH5220.....	233	AK0019L.....	32
AH4179.....	111	AH5230.....	233	AK0025.....	32
AH4180.....	111	AH5240.....	234	AK0035.....	33
AH4180T.....	111	AH5250.....	236	AK0038.....	32

# PRODUCT NUMBER LOOKUP

AK0041.....	33	AK6160P500.....	28	AK6175SPT500.....	25
AK0060.....	32	AK6160P550.....	28	AK6175SPT550.....	25
AK0061.....	32	AK6160P600.....	28	AK6175SPT600.....	25
AK5002.....	29	AK6160PT200.....	26	AK6180.....	23
AK5003.....	29	AK6160PT250.....	26	AK6216.....	29
AK5004.....	30	AK6160PT300.....	26	AK6230-2.....	23
AK5005.....	29	AK6160PT350.....	26	AK6230-3.....	23
AK5015.....	24	AK6160PT400.....	26	AK6235-2.....	29
AK5017.....	30	AK6160PT450.....	26	AK6235-3.....	29
AK6000-45.....	20	AK6160PT500.....	26	AK6410.....	19
AK6001-45.....	20	AK6160PT550.....	26	AK6411.....	19
AK6002-45.....	20	AK6160PT600.....	26	AK6412.....	19
AK6003-45.....	20	AK6160SPT200.....	26	AK6413.....	19
AK6005-45.....	20	AK6160SPT250.....	26	AK6415.....	19
AK6007S.....	20	AK6160SPT300.....	26	AK6419.....	19
AK6009S.....	20	AK6160SPT350.....	26	AK6424.....	19
AK6010-45.....	21	AK6160SPT400.....	26	AK6427.....	19
AK6011-45.....	21	AK6160SPT450.....	26	AK6449.....	19
AK6012-45.....	21	AK6160SPT500.....	26	AK6450.....	19
AK6013-45.....	21	AK6160SPT550.....	26	AK6451.....	19
AK6015-45.....	21	AK6160SPT600.....	26	AK6452.....	20
AK6016-60.....	24	AK6175.....	24	AK6453.....	20
AK6017S.....	21	AK6175A.....	24	AK6454.....	20
AK6019S.....	21	AK6175P200.....	27	AK6455.....	20
AK6021S.....	21	AK6175P250.....	27	AK6456.....	20
AK6022S.....	21	AK6175P300.....	27	AK6458.....	20
AK6023S.....	20	AK6175P350.....	27	AK6459.....	19
AK6024S.....	21	AK6175P400.....	27	AK6461.....	19
AK6026.....	24	AK6175P450.....	27	AK6465.....	19
AK6030.....	23	AK6175P500.....	27	AL0100.....	243
AK6040.....	22	AK6175P550.....	27	AL0110.....	244
AK6041.....	22	AK6175P600.....	27	AL0120.....	244
AK6044.....	22	AK6175PC.....	27	AL0120 S.....	244
AK6047.....	21	AK6175PT200.....	25	AL0121 S.....	244
AK6050.....	21	AK6175PT250.....	25	AL0126.....	245
AK6051.....	22	AK6175PT300.....	25	AL0130.....	245
AK6052.....	22	AK6175PT350.....	25	AL0133.....	246
AK6053.....	22	AK6175PT400.....	25	AL0140.....	243
AK6054.....	22	AK6175PT450.....	25	AL0140S.....	243
AK6058.....	22	AK6175PT500.....	25	AL0141.....	242
AK6059.....	22	AK6175PT550.....	25	AL0143.....	245
AK6060.....	22	AK6175PT600.....	25	AL0145 H.....	243
AK6064.....	22	AK6175SP200.....	28	AL0150.....	246
AK6065.....	22	AK6175SP250.....	28	AL0151.....	246
AK6067.....	22	AK6175SP300.....	28	AL0152.....	248
AK6070-60.....	21	AK6175SP350.....	28	AL0153.....	247
AK6072.....	21	AK6175SP400.....	28	AL0160.....	246
AK6130.....	23	AK6175SP450.....	28	AL0165.....	246
AK6150.....	24	AK6175SP500.....	28	AL0175.....	247
AK6160.....	24	AK6175SP550.....	28	AL0180.....	245
AK6160A.....	24	AK6175SP600.....	29	AL0185.....	248
AK6160P200.....	28	AK6175SPT200.....	25	AL0190.....	242
AK6160P250.....	28	AK6175SPT250.....	25	AL0300.....	242
AK6160P300.....	28	AK6175SPT300.....	25	AL0301.....	242
AK6160P350.....	28	AK6175SPT350.....	25	AL0340.....	238
AK6160P400.....	28	AK6175SPT400.....	25	AL0390.....	238
AK6160P450.....	28	AK6175SPT450.....	25	AL0400.....	238



# PRODUCT NUMBER LOOKUP

AL0450.....	238	AM0127.....	197	AN0140.....	186
AL0470.....	247	AM0128.....	197	AN0145.....	191
AL0480.....	240	AM0330.....	126	AN0150.....	186
AL0490.....	240	AM0330 12.....	126	AN0150TI.....	186
AL0500.....	240	AM0330 13.....	126	AN0160.....	186
AL0520 N/K.....	239	AM0330 14.....	126	AN0160TI.....	187
AL0520 N/V.....	239	AM0330 15.....	126	AN0170.....	191
AL0520 S.....	239	AM0330 16.....	126	AN0170T.....	187
AL0520 T/K.....	239	AM0330 17.....	126	AN0180.....	190
AL0520 T/K TI.....	239	AM0330 18.....	126	AN0180TI.....	190
AL0520 T/V.....	239	AM0330 19.....	126	AN0190.....	190
AL0520 T/V TI.....	239	AM0330 20.....	126	AN0200.....	191
AL0521 S.....	239	AM0330 21.....	126	AN0200TI.....	191
AL0523 T/K.....	240	AM0330 22.....	126	AN0210.....	186
AL0523 T/V.....	240	AM0330 23.....	126	AN0210TI.....	186
AL0525.....	240	AM0330 SET.....	127	AN0220.....	190
AL0530.....	241	AM0410.....	202	AN0230.....	188
AL0533.....	241	AM0410 1.00.....	202	AN0240.....	188
AL0534.....	241	AM0510.....	259	AN0240TI.....	188
AL1100.....	199	AM0560.....	162	AN0250.....	188
AL1110.....	199	AM0570 15.....	258	AN0260.....	191
AL1120.....	199	AM0570 20.....	257	AN0270.....	187
AL1130.....	199	AM0570 25.....	257	AN0280.....	187
AL1280.....	178	AM0570 30.....	257	AN0290.....	187
AL1320.....	176	AM0570 40.....	257	AN0300.....	187
AL1330.....	176	AM0570 45.....	257	AN0300TI.....	187
AL1340.....	176	AM0570 50.....	257	AN0310.....	187
AL1350.....	176	AM0570 60.....	257	AN0320.....	191
AL1360.....	176	AM0570 65.....	257	AN0350TI.....	191
AL1370.....	177	AM0570 67.....	257	AN0400.....	188
AL1375.....	176	AM0570 70.....	258	AN0410.....	188
AL1380.....	177	AM0570 72.....	258	AN0430.....	188
AL1390.....	178	AM0570 75.....	258	AN0440.....	188
AL1400.....	177	AM0570 77.....	258	AN0460.....	189
AL1410.....	178	AM0570 80.....	258	AN0470.....	192
AL1420.....	177	AM0570 82.....	258	AN0480.....	189
AL1430.....	178	AM0570 85.....	258	AN0490.....	192
AL1440.....	178	AM0570 87.....	258	AN0500.....	189
AL1450.....	178	AM0570 90.....	258	AN0510.....	186
AL1460.....	178	AM0570 95.....	258	AN0520.....	192
AL1530.....	177	AM0570 100.....	258	AN0525.....	192
AL2110.....	121	AM0570 105.....	258	AN0540.....	189
AL2120.....	121	AM0570 110.....	258	AN0560.....	192
AL2130.....	121	AM0570 115.....	258	AN0600.....	189
AL2140.....	121	AM0570 140.....	258	AN0610.....	193
AL2150.....	121	AM0570 160.....	258	AN0620.....	189
AL2155.....	121	AM0830.....	36	AN0625.....	192
AL2180.....	122	AM0831.....	36	AN0700.....	193
AL2210.....	122	AM0940.....	343	AR0120.....	41
AL3190.....	241	AM0970.....	343	AR0121.....	41
AL3300.....	122	AM0975.....	343	AR0121TI.....	41
AM0100.....	196	AM7550.....	344	AR0126.....	42
AM0105.....	196	AM9050.....	346	AR0127.....	42
AM0110.....	197	AN0110.....	190	AR0129.....	42
AM0120.....	197	AN0110TI.....	190	AR0132.....	42
AM0125.....	197	AN0120.....	186	AR0140.....	40
AM0126.....	197	AN0130.....	190	AR0145.....	46



# PRODUCT NUMBER LOOKUP

AR0146	45	AS0170	208	AS4150	217
AR0148	45	AS0180	207	AS4160	217
AR0150	40	AS0190	208	AS4170	220
AR0150TI	40	AS0200	208	AS4190	218
AR0155	40	AS0210	209	AS4200	218
AR0190	126	AS0220	210	AS4510	220
AR0190TI	126	AS0230	210	AS4520	221
AR0191	126	AS0240	220	AS4530	221
AR0197	126	AS0290	210	AS4540	222
AR0200	126	AS0301	213	AS4550	221
AR0250 4.00	43	AS0310	206	AS4560	221
AR0250 4.50	43	AS0320	207	AS4570	222
AR0250 5.00	43	AS0900	213	AS4575	222
AR0250 5.50	44	AS0940	213	AS4576	222
AR0250 5.75	44	AS1105	207	AS4580	216
AR0250 6.00	44	AS1110	207	AS4590	223
AR0250 8.00	44	AS1115	207	AS4600	223
AR0250 8.5	44	AS1120	207	AS4610	223
AR0250 9.00	44	AS1140	209	AS4620	223
AR0260	40	AS1150	208	AS5100	216
AR0370 2.50	45	AS1160	208	AS5110	215
AR0370 3.00	45	AS1170	209	AS5120	211
AR0370 3.50	45	AS1190	209	AS5130	211
AR0370 4.00	45	AS1200	208	AS5140	212
AR0370 5.00	45	AS1210	209	AS5150	215
AR0370 5.75	45	AS1220	209	AS5160	211
AR0370 6.00	45	AS1270	210	AS5170	212
AR0370 7.00	45	AS1290	210	AS5180	215
AR0370 8.00	45	AS2100	211	AS5190	224
AR0370 9.00	45	AS2110	210	AS5200	224
AR0380	41	AS2120	210	AS5210	225
AR0395	127	AS2310	212	AS5220	224
AR0400 8	44	AS2320	212	AS5235	216
AR0400 12	44	AS2390	212	AS5240	224
AR0420	127	AS3100	213	AS5250	225
AR0430	127	AS3110	213	AS5510	225
AR0580	180	AS3120	214	AS5520	225
AR0585	180	AS3130	214	AS5530	225
AR0600	180	AS3140	215	AS5540	226
AR0602	180	AS3160	214	AS5550	226
AR0603	180	AS3170	215	AS5560	209
AR0605	180	AS3185	214	AS5570	226
AR0610	180	AS3190	214	AS5580	226
AR0616	180	AS3200	215	AS5590	226
AR4120	42	AS3210	215	AS5600	227
AR4130	44	AS3220	215	AS5610	227
AR4150	45	AS3500	218	AS5630	227
AR8000	43	AS3510	218	AS5640	227
AR8001	43	AS3520	219	AS5650	228
AR8002	43	AS3530	219	AS5660	227
AS0100	206	AS3540	219	AS5670	227
AS0110	206	AS3550	219	AS5680	227
AS0120	206	AS4100	214	AS5900	219
AS0130	207	AS4110	214	AS5910	216
AS0140	208	AS4120	217	AS6510	224
AS0150	207	AS4130	220	AS6515	223
AS0160	208	AS4140	217	AS6516	223

# PRODUCT NUMBER LOOKUP

AT0155.....	253	AX10830.....	308	AX11750.....	304
AT0160.....	254	AX10836.....	324	AX11774.....	317
AT0170.....	254	AX10852.....	323	AX11795.....	287
AT0170 BTTM MAT.....	254	AX10853.....	48	AX11798.....	317
AT0190.....	253	AX10870.....	324	AX11799.....	317
AT0195.....	253	AX10900.....	325	AX11823.....	291
AT0200.....	253	AX10905.....	296	AX11830.....	319
AT0210.....	253	AX10914.....	49	AX11881.....	318
AT0225.....	253	AX10918.....	318	AX11886.....	307
AT0241.....	252	AX10919.....	295	AX11891.....	60
AT0242.....	252	AX10923.....	290	AX11929.....	306
AT0281.....	252	AX10943.....	318	AX11940.....	301
AT0600.....	254	AX10957.....	322	AX11941.....	301
AT0601.....	254	AX10981.....	318	AX11943.....	293
AX0208.....	288	AX10982.....	318	AX11956.....	52
AX0951.....	307	AX11011.....	298	AX11971.....	294
AX9810.....	297	AX11013.....	340	AX11998.....	315
AX9811.....	297	AX11032.....	309	AX12010.....	311
AX10055.....	299	AX11033.....	305	AX12024.....	324
AX10085.....	315	AX11038.....	340	AX12025.....	331
AX10086.....	315	AX11042.....	338	AX12039.....	293
AX10087.....	315	AX11069.....	324	AX12042.....	307
AX10088.....	315	AX11186.....	324	AX12045.....	48
AX10089.....	315	AX11208.....	331	AX12048.....	323
AX10092.....	316	AX11213.....	299	AX12069.....	335
AX10095.....	300	AX11240.....	301	AX12076.....	286
AX10126.....	295	AX11250.....	288	AX12077.....	287
AX10146.....	302	AX11261.....	51	AX12080.....	52
AX10155.....	342	AX11265.....	317	AX13009.....	317
AX10170.....	294	AX11288.....	330	AX13014.....	66
AX10193.....	313	AX11290.....	339	AX13038.....	338
AX10235.....	317	AX11347.....	310	AX13055.....	298
AX10240.....	290	AX11348.....	60	AX13070.....	196
AX10319.....	294	AX11369.....	318	AX13135.....	324
AX10339.....	294	AX11396.....	334	AX13136.....	324
AX10388.....	289	AX11397.....	334	AX13144.....	278
AX10400.....	337	AX11419.....	310	AX13164.....	303
AX10413.....	341	AX11432.....	321	AX13167.....	335
AX10414.....	48	AX11455.....	325	AX13185.....	306
AX10432.....	304	AX11463.....	52	AX13195.....	298
AX10438.....	298	AX11506.....	306	AX13207.....	302
AX10439.....	298	AX11593.....	290	AX13238.....	331
AX10445.....	311	AX11626.....	321	AX13251.....	291
AX10494.....	311	AX11627.....	322	AX13254.....	51
AX10502.....	292	AX11630.....	53	AX13258.....	336
AX10508.....	303	AX11638.....	340	AX13262.....	292
AX10516.....	316	AX11640.....	293	AX13284.....	286
AX10525.....	309	AX11642.....	288	AX13288.....	340
AX10545.....	342	AX11646.....	321	AX13328.....	287
AX10560.....	308	AX11649.....	322	AX13347.....	339
AX10591.....	303	AX11681.....	319	AX13360.....	297
AX10649.....	68	AX11683.....	318	AX13364.....	287
AX10683.....	325	AX11684.....	320	AX13424.....	308
AX10735.....	288	AX11688.....	320	AX13426.....	293
AX10761.....	59	AX11696.....	304	AX13441.....	307
AX10806.....	330	AX11715.....	320	AX13674.....	305
AX10807.....	331	AX11737.....	323	AX13832.....	337

# PRODUCT NUMBER LOOKUP

AX13843.....	296	AX14581.....	48	AX14655.....	50
AX13929.....	196	AX14582.....	48	AX14656.....	50
AX13930.....	196	AX14583.....	49	AX14657.....	50
AX13932.....	330	AX14584.....	49	AX14658.....	50
AX13975.....	325	AX14585.....	49	AX14659.....	50
AX13979.....	332	AX14586.....	49	AX14660.....	50
AX13981.....	295	AX14587.....	49	AX14661.....	50
AX13984.....	339	AX14588.....	49	AX14662.....	50
AX13986.....	300	AX14590.....	49	AX14663.....	50
AX14020.....	313	AX14591.....	50	AX14664.....	50
AX14029.....	196	AX14592.....	49	AX14665.....	54
AX14039.....	274	AX14593.....	49	AX14666.....	54
AX14040.....	274	AX14594.....	50	AX14667.....	54
AX14041.....	275	AX14595.....	53	AX14668.....	54
AX14042.....	275	AX14597.....	53	AX14669.....	54
AX14043.....	275	AX14601.....	53	AX14670.....	54
AX14045.....	277	AX14602.....	53	AX14671.....	54
AX14046.....	277	AX14603.....	53	AX14672.....	54
AX14051.....	289	AX14604.....	53	AX14673.....	54
AX14058.....	337	AX14605.....	52	AX14674.....	54
AX14092.....	319	AX14607.....	52	AX14675.....	54
AX14105.....	306	AX14611.....	52	AX14676.....	54
AX14112.....	14	AX14613.....	53	AX14677.....	54
AX14116.....	312	AX14614.....	53	AX14678.....	54
AX14137.....	299	AX14615.....	52	AX14679.....	54
AX14139.....	314	AX14617.....	52	AX14680.....	55
AX14154.....	334	AX14619.....	52	AX14681.....	56
AX14173.....	342	AX14621.....	52	AX14682.....	56
AX14179.....	299	AX14623.....	52	AX14683.....	56
AX14189.....	298	AX14624.....	52	AX14684.....	56
AX14191.....	300	AX14625.....	51	AX14685.....	56
AX14229.....	341	AX14627.....	51	AX14686.....	56
AX14249.....	297	AX14628.....	51	AX14687.....	56
AX14250.....	294	AX14629.....	51	AX14688.....	56
AX14262.....	302	AX14630.....	51	AX14689.....	56
AX14267.....	336	AX14631.....	52	AX14690.....	56
AX14271.....	340	AX14632.....	52	AX14691.....	55
AX14280.....	300	AX14633.....	52	AX14692.....	55
AX14287.....	314	AX14634.....	52	AX14693.....	55
AX14291.....	338	AX14635.....	51	AX14694.....	55
AX14343.....	293	AX14636.....	51	AX14695.....	55
AX14348.....	301	AX14637.....	51	AX14696.....	55
AX14349.....	289	AX14638.....	51	AX14697.....	55
AX14425.....	302	AX14639.....	51	AX14698.....	55
AX14457.....	340	AX14640.....	51	AX14699.....	55
AX14460.....	310	AX14641.....	51	AX14700.....	56
AX14475.....	336	AX14642.....	51	AX14701.....	56
AX14487.....	341	AX14643.....	51	AX14702.....	56
AX14488.....	289	AX14644.....	51	AX14703.....	56
AX14510.....	275	AX14645.....	50	AX14704.....	56
AX14533.....	196	AX14646.....	50	AX14705.....	57
AX14568.....	48	AX14647.....	50	AX14706.....	57
AX14571.....	48	AX14648.....	50	AX14707.....	57
AX14572.....	48	AX14651.....	51	AX14708.....	57
AX14576.....	48	AX14652.....	51	AX14710.....	57
AX14577.....	48	AX14653.....	51	AX14711.....	58
AX14580.....	48	AX14654.....	51	AX14713.....	57

# PRODUCT NUMBER LOOKUP

AX14714.....	58	AX14819.....	69	AX15161.....	301
AX14715.....	58	AX14820.....	69	AX15167.....	294
AX14719.....	59	AX14821.....	70	AX15181.....	339
AX14720.....	59	AX14822.....	70	AX15190.....	301
AX14721.....	59	AX14824.....	70	AX15194.....	286
AX14722.....	59	AX14825.....	70	AX15227.....	75
AX14723.....	58	AX14826.....	70	AX15229.....	326
AX14724.....	58	AX14827.....	71	AX15230.....	327
AX14725.....	58	AX14828.....	71	AX15245.....	338
AX14726.....	63	AX14829.....	72	AX15249.....	300
AX14727.....	62	AX14830.....	71	AX15314.....	291
AX14728.....	63	AX14831.....	72	AX15324.....	299
AX14730.....	62	AX14832.....	71	AX15325.....	299
AX14731.....	60	AX14833.....	71	AX15329.....	296
AX14732.....	60	AX14834.....	72	AX15346.....	312
AX14735.....	63	AX14835.....	71	AX15355.....	332
AX14736.....	61	AX14836.....	72	AX15372.....	293
AX14737.....	61	AX14837.....	71	AX15390.....	295
AX14739.....	60	AX14838.....	72	AX15402.....	328
AX14742.....	62	AX14839.....	72	AX15429.....	315
AX14743.....	61	AX14840.....	72	AX15430.....	315
AX14745.....	62	AX14841.....	72	AX15435.....	296
AX14749.....	63	AX14843.....	70	AX15461.....	337
AX14751.....	62	AX14844.....	73	AX15468.....	332
AX14752.....	60	AX14845.....	73	AX15487.....	339
AX14753.....	60	AX14846.....	73	AX15490.....	292
AX14754.....	64	AX14847.....	73	AX15553.....	315
AX14755.....	63	AX14848.....	73	AX15555.....	298
AX14756.....	64	AX14849.....	73	AX15581.....	75
AX14757.....	64	AX14850.....	73	AX15590.....	313
AX14758.....	64	AX14851.....	74	AX15630.....	75
AX14759.....	64	AX14852.....	74	AX15635.....	70
AX14760.....	64	AX14853.....	74	AX15636.....	70
AX14763.....	65	AX14855.....	74	AX15643.....	315
AX14764.....	65	AX14889.....	323	AX15644.....	315
AX14765.....	65	AX14906.....	292	AX15672.....	337
AX14766.....	65	AX14908.....	305	AX15689.....	335
AX14767.....	65	AX14910.....	326	AX15723.....	312
AX14772.....	66	AX14964.....	320	AX15736.....	340
AX14773.....	67	AX14965.....	321	AX15752.....	341
AX14775.....	67	AX14968.....	319	AX15809.....	342
AX14776.....	67	AX14993.....	336	AX20001.....	75
AX14777.....	67	AX14994.....	309	AX20001-BULK.....	75
AX14778.....	66	AX15012.....	326	AX111637.....	48
AX14780.....	67	AX15014.....	295	AX111642.....	48
AX14781.....	67	AX15021.....	323	AX115027.....	48
AX14784.....	66	AX15042.....	312	AX121273.....	53
AX14785.....	68	AX15044.....	327	AX121273-BULK.....	53
AX14786.....	68	AX15047.....	332	AX121273A.....	52
AX14802.....	68	AX15052.....	297	AX121273A-BULK.....	52
AX14808.....	68	AX15063.....	327	AX121273D.....	66
AX14809.....	69	AX15106.....	299	AX121274.....	53
AX14810.....	69	AX15112.....	322	AX121276.....	53
AX14811.....	69	AX15118.....	316	AX121276A.....	52
AX14812.....	69	AX15155.....	323	AX121277.....	55
AX14817.....	69	AX15156.....	314	AX121277B.....	51
AX14818.....	69	AX15160.....	300	AX121278.....	53

## PRODUCT NUMBER LOOKUP

AX121279A.....	55	AX131610.....	61	AX155075.....	58
AX121280.....	52	AX131610-BULK.....	61	AX161571.....	57
AX121638.....	52	AX131610A.....	61	AX165040.....	65
AX121639.....	52	AX131618.....	62	AX165040-BULK.....	65
AX125029.....	67	AX135004.....	61	AX165041.....	65
AX125037.....	66	AX135042.....	63	AX175005.....	65
AX125037-BULK.....	66	AX135049.....	61	AX175041.....	65
AX125155.....	68	AX135093.....	62	AX205256.....	74
AX125157.....	67	AX135113.....	62	AX721502.....	14
AX125158.....	66	AX151287.....	59	AX721532.....	14
AX125176.....	49	AX151297.....	59		
AX131599.....	60	AX151297-BULK.....	59		

**ORDERING**

Call toll free 1 (800) 979.2020 US and Canada  
(610) 889.0200 International  
+31 (0) 485.350300 Europe  
Fax: (610) 889.3233  
info@accutome.com

 **Buy Online!**  
accutome.com



3222 Phoenixville Pike, Building #50 • Malvern, PA 19355 USA  
European Office: Simon Homburgstraat 21 • 5431 NN, Cuijk, NL

Distributed by: