

Surgical Product Catalog





ORDERING

Call toll free 1.(800) 979.2020 US and Canada
(610) 889.0200 International
+31 (0) 485.350300 Europe
Fax: (610) 889.3233
info@accutome.com



Buy Online!

accutome.com

3222 Phoenixville Pike, Building #50 • Malvern, PA 19355 USA
European Office: Simon Homburgstraat 21 • 5431 NN, Cuijk, NL

About Us

Accutome is entering our fourth decade in the ophthalmic industry. The three major traits that keep the Accutome brand growing remain the same: superior customer service, quality, innovation. It is our goal to make every experience you have with us special and productive.

Our focus is to continue to improve our product line and customer service to better suit your needs. We are constantly adding more customer service and sales representatives to provide worldwide support. We also have a European office in the Netherlands.

We have become a total solutions provider for all of your ophthalmic needs by supplying quality products such as office medications, supplies, surgical instruments, and diagnostic equipment. We carry thousands of products to meet your needs. If you do not see a particular item, give our representatives a call, and we will find it for you.

Accutome Surgical Instruments and Supplies

Accutome offers a full line of diamond and metal surgical blades along with handheld surgical instruments and surgical disposable products. We are one of the top production and repair facilities of diamond knives. We cross-reference and competitively bid on all major brands of ophthalmic instruments - just send us your list for a quote.

Our reputation for innovation has been developed based on our relationships with top surgeons. Do you have an idea for a new instrument? Give us a call to discuss your idea.

Accutome Repair Center

Our state-of-the-art repair and technical support center is staffed by highly trained technicians. We offer expert repairs on all brands of ophthalmic surgery instruments and ultrasound. We are also experts in diamond knife repair, having one of the largest diamond repair facilities in the U.S. Accutome can customize diamond blades to your specifications and the Diamond Exchange Program allows you to downsize existing blades for a low cost. Most brands and styles can be repaired by us, usually in 24 hours. Our instrument repair unit can sharpen or repair surgical instruments, making them like new.

Accutome Diagnostic Equipment

Accutome offers a broad line of ophthalmic diagnostic equipment. We started in the 1980s by developing the first ophthalmic pachymeter. Today, we feature a full line of diagnostic equipment including: 4Sight, A-Scan Plus Connect, B-Scan Plus, UBM Plus, PachPen handheld pachymeter, AccuPach VI, and AccuPen handheld tonometer.

As an extension of our great customer service, Accutome also offers in-house diagnostic product specialists. Our specialists are available during work hours, Monday through Friday 8am to 8pm EST.

Accutome Office Medications and Supplies

Accutome carries thousands of diagnostic pharmaceuticals and clinical exam supplies. There are no minimum order requirements, and most products ship out on the same day. We run quarterly specials on our most popular products, which can be found on our website at www.accutome.com.

ACCUSHARP DISPOSABLE OPHTHALMIC KNIVES

NON-GUARDED DISPOSABLE OPHTHALMIC KNIVES12

AccuSharp Ophthalmic Angled Slit Knife.....	12
AccuSharp Ophthalmic Straight Knife.....	13
AccuSharp Ophthalmic Sideport/MVR Knife	13
AccuSharp Ophthalmic Crescent Knife	14
AccuSharp Ophthalmic Angled Implant Knife.....	14
Stab Knife	14

GUARDED DISPOSABLE OPHTHALMIC KNIVES.....15

AccuSharp Guarded Ophthalmic Angled Slit Knife.....	15
AccuSharp Guarded Ophthalmic Straight Knife	15
AccuSharp Guarded Ophthalmic Sideport/MVR Knife	15
AccuSharp Guarded Ophthalmic Crescent Knife.....	16
AccuSharp Guarded Ophthalmic LRI Knife.....	16

DIAMOND KNIVES

PHACO INCISION DIAMOND KNIVES19

Simplicity Series	19
Simplicity Trapezoid Series	19
Dual Bevel Diamond Knife (Dual Sides Sharp)	20
Dual Bevel Diamond Knife (Four Sides Sharp)	21
Dual Bevel Trapezoid Diamond Knife	21

SPECIALTY DIAMOND KNIVES22

Crescent Diamond Knife.....	22
Sclerostomy Diamond Knife.....	23
Universal Cataract Diamond Knife.....	23

PARACENTESIS/STAB DIAMOND KNIVES.....23

Hawkeye Series	23
Hawkeye Premium Series	24

ASTIGMATISM MANAGEMENT DIAMOND KNIVES.....25

Donnenfeld Preset LRI, Long Handle.....	25
Donnenfeld Preset LRI, Short Handle.....	25
Donnenfeld Preset Truncated Lancet, Long Handle	26
Donnenfeld Preset Truncated Lancet, Short Handle	26
Chang LRI Diamond Knife.....	27
Rubenstein Preset LRI, Long Handle.....	27
Rubenstein Preset Truncated Lancet, Long Handle	28
Rubenstein Preset LRI, Short Handle	28
Surgeon's Choice Adjustable	29
Micrometer	29

SAPPHIRE KNIVES

KERATOME SAPPHIRE KNIVES32

Clear Cornea Sapphire Knife	32
Spears Sapphire Knife	32
Trapezoid Sapphire Knife.....	32

CRESCENT SAPPHIRE KNIVES33

Crescent Sapphire Knife.....	33
------------------------------	----

SAPPHIRE STAB KNIVES.....33

Lancet Sapphire Knife	33
Single-Edge Sapphire Knife	33
Trifacet Sapphire Knife	33

BIPOLAR INSTRUMENTS

BIPOLAR CABLES & PROBES.....36

Bipolar Cables	36
Cautery Probe.....	36

BIPOLAR FORCEPS36

Adson Bipolar Forceps.....	36
Coaptation Bipolar Forceps.....	37
Jewelers Bipolar Forceps	37
McPherson Bipolar Forceps.....	37
Shepard Bipolar Forceps	38

CALIPERS, GAUGES & MARKERS

CALIPERS40

Braunstein Fixed Caliper	40
Castroviejo Caliper.....	40
Jameson Caliper	40
Stahl Corneal Caliper	41

GAUGES41

Mendez Degree Gauge.....	41
--------------------------	----

MARKERS.....41

Bores Axis Marker	41
Chayet Marker	42
Dell LRI Astigmatism Marker.....	42
Devgan Axis Marker	43
Hoffer Optical Zone Marker.....	43
LASIK Corneal Marker.....	44
Osher-Neumann Radial Incision Marker	44
Plain Optical Zone Marker.....	45
Rubenstein LASIK Corneal Marker.....	45
Toric Lens Marker.....	45
Toric Reference Marker	46

CANNULAS & CYSTOTOMES

ACCUSURGICAL SINGLE-USE CANNULAS & CYSTOTOMES48

Atkinson Retrobulbar Needle	48
Atkinson Peribulbar Needle.....	48
Non Atkinson Retrobulbar Needle	48
Non Atkinson Peribulbar Needle	49
Sub Tenon Anesthesia Cannula	49
Rous Sub Tenon/Parabulbar Needle.....	50

Anterior Chamber Cannula, Angled	50	LASIK Cannula [Slade].....	74
Anterior Chamber Cannula, Straight	54	LASIK Cannula [Linn].....	74
Anterior Chamber Cannula, Curved	54	Refractive Cannula.....	74
Air Injection Cannula	55	Femtosecond Cannula [Solomon].....	75
Viscoelastic Cannula	55	Brody Femtosecond Dissecting Cannula	75
Thin Wall Anterior Chamber Cannula, Angled	55	AccuDrop Cannula	75
Thin Wall Anterior Chamber Cannula, Curved	56	REUSABLE CANNULAS & CYSTOTOMES.....	76
Thin Wall Anterior Chamber Cannula, Straight	56	Atkinson Retrobulbar Needle	76
Double I/A Cannula	57	Air Injection Cannula	76
J-Shaped Double I/A Cannula.....	57	Gills-Welsh Aspirating Cannula	77
Double Barrel I/A Cannula [Simcoe]	57	McIntyre Anterior Chamber Cannula.....	78
Cortex Extractor [Charleux].....	57	McIntyre-Binkhorst Irrigating Cannula.....	79
Cortex Extractor [Simcoe]	58	Bishop-Harmon Irrigating Cannula.....	79
Button Coaxial I/A System	58	Bishop-Harmon Irrigating Cannula Bulb	80
J-Shaped Cannula	58	Adapter for Irrigators	80
J-Shaped Cannula [Binkhorst].....	59	Bishop-Harmon Irrigating Cannula Set	81
Micro J-Shaped Cannula [Hessburg]	59	Cystotome Cannula	81
Irrigating Cystotome.....	60	Lewicky Cystotome	81
Irrigating Double Sharp Cystotome [Kelman]	63	Hydrodissection Cannula	81
Irrigating Sharp Cystotome [Kelman]	64	Akahoshi II Hydrodissection Cannula.....	83
Capsule Polisher	64	Chang Nucleus Hydrodissection Cannula.....	83
Posterior Capsule Polisher	64	Simcoe Cortex Extractor Cannula	84
Silicone Tip Capsule Polisher	65	Infusion Cannula	84
Irrigating Vectis	65	Anis Cortex Aspirating Cannula.....	84
Bishop-Harmon Washout Cannula	65	Graether Collar Button Cannula	84
Nucleus Hydrodissection Cannula	66	Infusion Handle	85
Hydrodissection Cannula [Chang]	66	Henderson MICS Capsule Polisher Cannula.....	85
Hydrodissection Cannula [Kellan]	66	Jensen Capsule Polisher	86
J-Shaped Hydrodissection Cannula.....	67	Gills-Welsh Olive Tip Cannula	86
Hydrodelineation Needle [Kellan]	67	Lacrimal Cannula	86
Nucleus Hydrolysis Needle [P. Koch]	67	Bailey Lacrimal Cannula	87
Nucleus Hydrodissector/Rotator [Sinsky]	67	Fasanella Lacrimal Cannula	87
Cotrical Cleaving Hydrodissector	67	Simcoe I/A Cannula	88
Nucleus Hydrodissector	68	Slade LASIK Cannula	88
Lacrimal Cannula	68		
Irrigating Dialer	68	CAPSULE POLISHERS	
Alpha-Chymotrypsin Cannula.....	68	NON-IRRIGATING CAPSULE POLISHERS.....	90
Olive Tip Capsule Polisher	69	Accutome Capsule Polishing Sweeper and Curette	90
Chamber Maintainer	69	Gills-Welsh Capsule Polishing Curette.....	90
Chamber Maintainer with Serrated Tip	70	Holladay Posterior Capsule Polisher and Curette.....	90
Infusion Cannula	70	Nightingale Posterior Capsule Polishing Curette	90
Membrane Micropick [Eaton].....	70	Shepherd Capsule Polishing Curette.....	90
Retinal Backflush Cannula	70	Singer Sweep Polisher	91
Extrusion Cannula.....	71	Whitman Sheperd Capsule Polisher	91
Extrusion Cannula with Silicone Tubing	72	Accutome 360-Degree Capsule Polishing Curette.....	91
High Viscosity Fluid Cannula [Peyman]	72		
Membrane Dissector [Kingham]	72	CHALAZION INSTRUMENTS	
Subretinal Injector [Lambert].....	72	CURETTES	94
Subretinal Aspirator [Landers].....	72	Heath Chalazion Ring Curette.....	94
Vitreoretinal Micropick [Glaser]	73	Meyerhoeffer Chalazion Curette	94
Vitreoretinal Cannula [Vander].....	73		
Subretinal Injector [Glaser].....	73		
MVR Cannula [Glaser].....	73		
Subretinal Cannula [Lambert].....	74		
LASIK Cannula [Dishler]	74		

LENS MANIPULATORS & CHOPPERS

LENS MANIPULATORS 96

Anis Ball Tip Nucleus Manipulator	96
Barrett Duo Nucleus Rotator/Manipulator/Splitter	96
Bechert Lens Pusher	96
Bechert Nucleus Rotator	96
Clayman Nucleus Rotator	96
Drysdale Nucleus Manipulator	97
Fenzel Lens Manipulating Hook	97
Grayson Nucleus Manipulator	97
Grayson/Kuglen Double-Ended Manipulator	97
Hunkeler IOL Manipulator	98
Jaffe-Bechert Nucleus Rotator	98
Koch Phacoemulsification Manipulator	98
Koch Stop and Chop Manipulator	98
Lester IOL Manipulator	98
Lewicky Lens Manipulator Hook	99
Lieberman Microfinger Nucleus Manipulator	99
Lindstrom STAR Manipulator	100
Mackool Double-Ended Chopper and Spatula	100
Maloney No Hole IOL Manipulator	100
Maloney Nucleus Rotator	100
Maltsman-Fenzel Lens Manipulating Hook	100
Hunkeler IOL Manipulator	101
Masket Phaco Spatula	101
Nordan Capsule Elevator	101
O’Gawa Lens Dialer	101
Osher “Y” IOL Hook	102
Osher Iris Retractor	102
Osher Nucleus Manipulator	102
Pisacano Nucleus Rotator	102
Rentsch Boat Hook Lens Manipulator	103
Siepser Endocapsular Controller	103
Sinsky C-Hook, Modified	103
Sinsky Lens Manipulating Hook	103
Tennant Nucleus Manipulator	104

CHOPPERS 105

Accutome Wand	105
Akahoshi Nucleus Sustainer	105
Ambidextrous Seibel Nucleus Chopper	106
Castroviejo Dissector	106
Chang Microfinger Phaco Chopper and Quick Chopper	106
Chang-Seibel Microfinger Chopper and Vertical Safety Chopper	106
Davidoff Ambidextrous Nucleus Chopper	106
Dodick-Kammann Nucleus Chopper	107
Escaf Nucleus Sustainer	107
Fukasaku Snapper Chopper	107
Goldberg Sideport Splitter	107
Haefliger Phaco Cleaver	107
He Hook Chopper	108
Keener Lens/Nucleus Divider	108
Koch Spatula and Nagahara Chopper	108
Lieberman Microfinger and Spatula	108

Mackool Phaco Chopper	108
Mackool Phaco Chopper and Nucleus Chopper	109
Maloney Quick-Chop	109
Nagahara Fine Chopper and Nichamin Quick Chopper	109
Nagahara Phaco Chopper	109
Nichamin Double-Ended Nucleus Chopper and Spatula	110
Nichamin Quick Chopper	110
Nichamin Quick Chopper II	110
Nichamin Triple Chopper	110
Nucleus Chopper and Safety Quick Chopper	110
Rosen Chopper	111
Seibel Nucleus Chopper	111
Seibel Nucleus Chopper and Safety Quick Chopper	111
Seibel Safety Quick Chopper	111
Steinert II Nucleus Claw Chopper	112
Sweeney Manipulator Cracker	112
Verges Phaco Chopper	112

HOOKS & RETRACTORS

HOOKS 114

Bonn Iris Hook	114
Clayman Micro Iris Hook	114
Clayman-Jaffe Lens Manipulating Hook	114
Crawford Retrieving Hook	114
Crawford/Benger Probe Retrieving Hook	114
Culler Rectus Muscle Hook	115
Double Fixation Hook	115
Fukasaku Snapper Hook	115
Gass Retinal Detachment Hook	115
Graether Collar Button-Handle	115
Hirschman Iris Hook	116
Iris Hook	116
Jaffe Iris Hook	116
Jaffe Lens Manipulating Hook	116
Jaffe-Maltzman Lens Manipulating Hook	117
Kirby Expressor Double-Ended Hook and Loop	117
Kuglen Iris Hook Lens Manipulator	117
Maumenee Iris Hook	118
Shepard Iris Hook	118
Sinsky Iris and IOL Hook	119
Smith Expressor Hook	119
Stevens Tenotomy Hook	119
Twist Fixation Hook	119
Tyrell Iris Hook	120
University of Kansas Spatula and Hook	120
Green Strabismus Hook	120
Jameson Muscle Hook	120
Von Graefe Strabismus Hook	120

RETRACTORS 121

Berke-Jaeger Lid Plate	121
Conway Lid Retractor	121
Desmarres Lid Retractor	121
Knapp Lacrimal Sac Retractor	122

Pupil Iris Retractor.....	122
Rizzuti Expressor and Iris Retractor.....	122
Schepens Orbital Retractor.....	122

DSEK INSTRUMENTS

DSEK	124
Carlson DSEK Smoother.....	124
Descemet's DSEK/DSAEK Stripper.....	124
Rosenwasser Endothelial Stripper.....	124

FIXATION RINGS & PICKS

FIXATION RINGS.....	126
Fine-Thornton Fixation Ring.....	126
Flieringa Scleral Fixation Ring	126
Globe Fixation Ring.....	127
Thornton Fixation Ring	127
FIXATION PICKS	127
Anis Scleral Twist Fixation Cone	127
Burch Fixation Pick.....	128

FORCEPS & CLAMPS

CAPSULE FORCEPS.....	130
Arruga Capsule Forceps	130
Castroviejo Capsule Forceps.....	130
Gaskin Fragment Forceps	130
Kraff Capsule Tag Forceps.....	130
CAPSULORHEXIS FORCEPS	131
Devgan MICS Capsulorhexis Forceps.....	131
Gianetti MICS Capsulorhexis Forceps	131
Gimbel Capsulorhexis Forceps	131
Kellan Capsulorhexis Forceps.....	131
Lehner-Utrata Capsulorhexis Forceps	131
Masket Capsulorhexis Forceps.....	132
Nevyas Capsulorhexis Forceps.....	132
O'Gawa-Utrata Capsulorhexis Forceps	132
Utrata Capsulorhexis Forceps.....	132
Utrata MICS Capsulorhexis Forceps.....	134
CHALAZION FORCEPS	134
Baird Chalazion Forceps.....	134
Desmarres Chalazion Forceps	134
Francis Chalazion Forceps	134
Heath Chalazion Forceps.....	135
Hunt Chalazion Forceps	135
Lambert Chalazion Forceps	135
Wies Chalazion Forceps.....	135
CILIA FORCEPS	136
Barraquer Cilia Forceps	136
Cilia Forceps.....	136
Drews Cilia Forceps.....	136

Gradle Cilia Forceps.....	136
Swiss Cilia and Suture Forceps.....	137
CORNEAL FORCEPS	137
Castroviejo Colibri Corneal Forceps.....	137
Girard Corneoscleral Forceps.....	137
Hyde Corneal Forceps.....	138
Katzin-Barraquer Colibri Corneal Utility Forceps.....	138
Pierse Colibri Corneal Forceps	138
Polack Colibri Corneal Forceps	138
Thorpe Corneal Forceps.....	138
Troutman-Barraquer Colibri Corneal Forceps	139
DSEK FORCEPS	139
Charlie II Donor Forceps	139
Rossenwasser Donor Lamella Forceps.....	139
Snyder Stripping Forceps.....	140
DRESSING FORCEPS.....	140
Bishop-Harmon Dressing Forceps.....	140
Dressing Forceps	140
FEMTOSECOND FORCEPS	141
Femto LRI Enhancement Forceps.....	141
FIXATION FORCEPS	141
Castroviejo Fixation Forceps.....	141
Fechtner Conjunctiva Forceps	141
Graefe Fixation Forceps.....	142
Green Fixation Forceps	142
Kremer Corneal Fixation Forceps.....	142
Lester Fixation Forceps	142
McGregor Conjunctiva Forceps	142
Moody Fixation Forceps.....	143
Osher Fixation Forceps.....	143
Thorpe Conjunctiva Forceps.....	143
HEMOSTATIC FORCEPS	143
Hemostatic Forceps.....	143
Kelly Hemostatic Forceps.....	144
Sponge Forceps	144
IOL FORCEPS	145
Accutome Folding Forceps	145
Faulkner Lens Holding Forceps.....	145
Haberle-McPherson Lens Holding Forceps.....	145
Implant Removal Forceps.....	145
IOL Lens Loading Forceps	145
Accutome IOL Lens Loading Forceps	146
Livernois IOL Folding Forceps	146
Livernois IOL Holding Forceps.....	146
Steinert Folding Forceps	146
Universal II IOL Insertion Forceps.....	147
Universal III IOL Insertion Forceps.....	147
JEWELER FORCEPS.....	147
Jeweler Forceps	147
Suture Removal Forceps.....	148

Jewler's Type Utility and Splinter Forceps.....	148	CLAMPS	162
LASIK FORCEPS	149	Clamp.....	162
Buratto LASIK Flap Forceps	149	I/A & BIMANUAL HANDPIECES	
MUSCLE FORCEPS	149	DISPOSABLE I/A INSTRUMENTS.....	164
Berke Ptosis Forceps.....	149	Bimanual I/A System.....	164
Putterman Muscle Forceps	149	Mono-Manual I/A System.....	164
Troutman Superior Rectus Forceps	149	REUSABLE I/A INSTRUMENTS	165
PRE-CHOPPER FORCEPS	150	Bimanual Aspirating Unit	165
Akahoshi PreChop Forceps	150	Bimanual Aspiration Cannula Tip.....	166
D&K Salvitti Akahoshi PreChopping Forceps	150	Bimanual Irrigating Unit	166
Dodick Nucleus Cracker	150	Bimanual Irrigation Cannula Tip.....	167
Ernest Nucleus Cracker.....	150	Donnenfeld Irrigating Hook	167
Salz Nucleus Splitter	151	I/A Handpiece.....	167
RETINAL FORCEPS	151	I/A Tip	168
Scleral Plug Forceps	151	KNIFE HANDLES	
SUTURING FORCEPS.....	151	BARD-PARKER KNIFE HANDLES	172
Bonn Suturing Forceps	151	Bard-Parker Knife Handle.....	172
Castroviejo Suturing Forceps.....	152	BEAVER CHUCK KNIFE HANDLES.....	172
Fine-Castroviejo Suturing Forceps.....	153	Beaver Chuck Knife Handle	172
Kelman-McPherson Suturing Forceps.....	153	REUSABLE KNIVES	
Manhattan Eye and Ear Suturing Forceps.....	154	REUSABLE KNIVES.....	174
O'Gawa Suture Fixation Forceps	154	Gill Corneal Knife.....	174
Paufique Suturing Forceps.....	154	Martinez Double-Ended Corneal Dissector Knife	174
Stern-Castroviejo Suturing Forceps	154	Tooke Corneal Knife	174
TISSUE FORCEPS	155	LACRIMAL INSTRUMENTS	
Adson Tissue Forceps.....	155	LACRIMAL PROBES	176
Bishop-Harmon Tissue Forceps.....	155	Bowman Lacrimal Probe Set	176
Hoskins Tissue Forceps.....	155	Bowman Lacrimal Probe	176
Tissue Forceps	156	Catalano Intubation Probe Set	177
TYING FORCEPS	156	Pigtail Probe	177
Bechert-McPherson Angled Tying Forceps	156	Jackson Lacrimal Intubation Set.....	177
Castroviejo Tying Forceps.....	156	LACRIMAL DILATORS.....	177
Fine Tying Forceps	156	Castroviejo Double-Ended Lacrimal Dilator	177
Gerl Tying Forceps.....	157	Hosford Double-Ended Lacrimal Dilator.....	178
Girard Fine Tying Forceps	157	Infant Lacrimal Dilator.....	178
Harms-Tuebingen Tying Forceps	157	Muldoon Lacrimal Dilator.....	178
Jaffe Tying Forceps	157	Ruedemann Lacrimal Dilator.....	178
Kelman-McPherson Tying Forceps	158	Wilder Lacrimal Dilator	178
McPherson Tying Forceps.....	158	LASEK INSTRUMENTS	
O'Gawa Tying Forceps	159	LASEK INSTRUMENTS	180
O'Gawa-Castroviejo Tying Forceps	159	Camellin LASEK Trephine	180
Sheets-McPherson Tying Forceps	160	LASEK Alcohol Well	180
Tennant Tying Forceps.....	160		
UTILITY FORCEPS	161		
Alabama University Utility Forceps.....	161		
Bonaccolto Utility Forceps	161		
Gill Iris Forceps	161		
Kennerdell Bayonet Forceps	161		
Nugent Utility Forceps.....	161		
Wills Hospital Utility Forceps	162		

LASEK Epithelial Trephine	180	Schocket Double-Ended Scleral Depressor	199
LENS LOOPS		PUNCHES	
LENS LOOPS	182	PUNCHES	202
Gills-Welsh Lens Loop	182	Kelly Descemet's Membrane Punch.....	202
Kansas Lens Loop.....	182	RETINAL PICKS	
Keener-Alt Lens Loop	182	RETINAL PICKS	204
Kirby Intra-Capsular Lens Loop	182	Olk Angled Retinal Pick	204
Lewis Lens Loop.....	183	SCISSORS	
New Orleans Eye and Ear Lens Loop.....	183	CORNEAL SCISSORS	206
Simcoe Double-Ended Nucleus Loop	183	Aebli Corneal Scissors.....	206
Wilder Lens Loop.....	183	Aebli Corneal Section Scissors	206
NEEDLE HOLDERS		Manson-Aebli Corneal Scissors	207
LOCKING NEEDLE HOLDERS.....	186	Azar Corneal Scissors.....	207
Anis Needle Holder, Locking.....	186	Barraquer Corneal Section Scissors.....	207
Barraquer Needle Holder, Locking	186	Castroviejo Corneal Scissors	207
Castroviejo Needle Holder, Locking	187	Castroviejo Corneal Section Scissors	208
Jaffe Needle Holder	188	Castroviejo Keratoplasty Scissors.....	209
Kalt Needle Holder	188	Hoffer-Stern Scissors.....	209
McPherson Needle Holder	189	Katzin Corneal Transplant Scissors.....	210
Needle Holder, Locking	189	Troutman-Castroviejo Corneal Section Scissors.....	210
Troutman Needle Holder	189	Troutman-Katzin Corneal Transplant Scissors	210
NON-LOCKING NEEDLE HOLDERS	190	ENUCLEATION SCISSORS.....	210
Anis Needle Holder, Non-Locking	190	Enucleation Scissors	210
Barraquer Needle Holder, Non-Locking	190	EYE SCISSORS.....	211
Castroviejo Needle Holder, Non-Locking.....	191	Eye Scissors	211
Cohan Needle Holder	191	INTRAOCULAR SCISSORS	212
McPherson Needle Holder	192	Intraocular Scissors.....	212
Needle Holder, Non-Locking.....	192	IOL REMOVAL SCISSORS	213
O'Gawa Needle Holder	192	Accutome IOL Cutter.....	213
Osher Needle Holder	193	IRIS SCISSORS	213
Troutman Needle Holder	193	Barraquer Iris Scissors	213
OFFICE INSTRUMENTS		Cohan-Vannas Curved Iris Scissors	213
OPHTHALMIC BURRS	196	DeWecker Iris Scissors	214
Aaron Burr 2.....	196	Iris Scissors.....	214
Aaron Burr 2 Accessories	196	McPherson-Vannas Iris Scissors.....	215
Algerbrush II.....	196	MISCELLANEOUS SCISSORS.....	216
Algerbrush II Accessories	196	Mayo Dissecting Scissors	216
FOREIGN BODY INSTRUMENTS	197	Troutman Conjunctival Scissors	216
Ellis Foreign Body Spud.....	197	Westcott Conjunctival Scissors	216
Foreign Body Curette	198	STITCH SCISSORS	216
Foreign Body Spud.....	198	Castroviejo Mini Keratoplasty-Utility-Stitch Scissors	216
Francis Spud	198	Fine Stitch Scissors.....	217
Golf Club Spud.....	198	Jaffe Stitch Scissors	217
SCLERAL DEPRESSORS	199	McPherson-Westcott Stitch Scissors	217
Flynn Scleral Depressor.....	199		
Schepens Scleral Depressor	199		

Stitch Scissors.....	217	PHACO SPATULAS.....	234
Westcott Type Stitch Scissors	218	Gimbel Nucleus Spatula	234
STRABISMUS SCISSORS	218	Jaffe Lens Spatula.....	234
Knapp Strabismus Scissors.....	218	Johnson Spatula.....	234
Strabismus Scissors	219	Knolle Lens Nucleus Spatula and Anterior Chamber Gauge.....	234
SUTURE SCISSORS	219	Knolle Nucleus Spatula	235
Littler Suture/Dissecting Scissors.....	219	Koch Nucleus Spatula	235
Stitch Removal Scissors	220	Koch Phacoemulsification Spatula.....	235
TENOTOMY SCISSORS	220	Lieppman Nucleus Spatula	235
McPherson-Westcott Tenotomy Scissors	220	Rowen Phaco Spatula	235
Shepard-Westcott Tenotomy Scissors.....	220	REFRACTIVE SPATULAS	236
Stevens Tenotomy Scissors.....	221	Kimura Platinum Spatula.....	236
Westcott Tenotomy Scissors.....	223	Maloney PRK Spatula.....	236
UTILITY SCISSORS.....	223	Paton Spatula and Spoon.....	236
Lister Bandage Scissors	223	RETINAL SPATULAS	236
Operating Scissors	224	Maumenee-Barraquer Vitreous Sweep Spatula.....	236
Utility Scissors.....	224	SPECULUMS	
Westcott Type Utility Scissors	225	ADJUSTABLE SPECULUMS.....	238
VANNAS SCISSORS.....	225	Cook Eye Speculum	238
Gills-Vannas Capsulotomy Scissors	225	Kammann Eye Speculum.....	238
Gills-Welsh-Vannas Micro Scissors.....	226	Lancaster Eye Speculum.....	238
Stern-Gills Scissors.....	226	Lester-Burch Eye Speculum	238
Uribe-Stern Scissors	226	Lieberman Adjustable Speculum.....	239
Uthoff-Gills Capsulotomy Scissors	226	Schott Eye Speculum.....	240
Vannas Capsulotomy Scissors	227	Williams Eye Speculum.....	240
Vannas Scissors	227	ASPIRATING SPECULUMS	241
SPATULAS		Lieberman Aspirating Speculum	241
CYCLODIALYSIS SPATULAS.....	230	Machat LASIK Speculum	241
Barraquer Cyclodialysis Spatula.....	230	WIRE SPECULUMS.....	241
Castroviejo Cyclodialysis Spatula.....	230	Varley LASIK/Femtosecond Lid Speculum.....	241
Castroviejo Synechia Spatula	230	Alfonso Eye Speculum	242
Wheeler/Elschnig Cyclodialysis Spatula.....	231	Barraquer Lid Speculum.....	242
DSEK SPATULAS	231	Floyd-Barraquer Eye Speculum	246
Cindy Sweeper DSEK Spatula.....	231	Kratz-Barraquer Eye Speculum.....	246
FEMTOSECOND SPATULAS.....	231	Kratz-Nichamin Lid Speculum	246
Eippert Femtosecond Spatula.....	231	Lehner Lid Speculum	247
Lane Femtosecond Incisional Spatula	232	Sauer Eye Speculum	247
Lee Femtosecond Spatula.....	232	Slade Refractive Speculum	247
Slade Femtosecond Laser Spatula	232	Temporal Approach Wire Speculum	248
Suarez Spreader.....	232	SPOONS	
IRIS SPATULAS.....	233	EVISCERATION & ENUCLEATION SPOONS.....	250
Barraquer Iris Spatula.....	233	Bunge Evisceration Spoon	250
Culler Iris Spatula	233	Wells Enucleation Spoon	250
Iris Spatula	233	LENS SPOONS	250
LASIK SPATULAS	233	Culler Lens Spoon.....	250
Intralase Flap Lifter and Retreatment Spatula	233		
Katzen LASIK Flap “Unzipper”	234		

STERILIZATION TRAYS

METAL TRAYS	252
Metal Microsurgical Instrument Sterilization Tray.....	252
PLASTIC TRAYS	253
Diamond Knife Tray	253
Plastic Microsurgical Instrument Sterilization Tray	253
Plastic Phaco Instrument Sterilization Tray.....	254
Sterilization Tray Replacement Mat.....	254

TREPHINES & PUNCHES

DISPOSABLE TREPHINES & PUNCHES	256
Disposable Radial Vacuum Trepine	256
Vacuum Donor Punch	256
REUSABLE TREPHINES & PUNCHES	257
Long Reusable Trepine Blade.....	257
Universal Trepine Blade Holder	259

SUTURES

NYLON	262
Sutures 11-0 Nylon.....	262
Sutures 10-0 Nylon.....	263
Sutures 9-0 Nylon.....	265
Sutures 8-0 Nylon.....	266
Sutures 7-0 Nylon	267
Sutures 6-0 Nylon.....	269
Sutures 5-0 Nylon.....	270
POLYESTER	271
Sutures 10-0 Polyester	271
Sutures 5-0 Polyester.....	272
Sutures 4-0 Polyester.....	273
POLYGLYCOLIC ACID	274
Sutures 10-0 Polyglycolic Acid	274
Sutures 9-0 Polyglycolic Acid	275
Sutures 8-0 Polyglycolic Acid	275
Sutures 7-0 Polyglycolic Acid	276
Sutures 6-0 Polyglycolic Acid	276
Sutures 5-0 Polyglycolic Acid	277
POLYPROPYLENE	278
Sutures 6-0 Polypropylene.....	278
SILK	278
Sutures 8-0 Silk	278
Sutures 7-0 Silk	279
Sutures 6-0 Silk	280
Sutures 5-0 Silk	281
Sutures 4-0 Silk	282

SURGICAL DISPOSABLES

APPAREL	286
Exam Gown	286
Isolation and Fluid-Resistant Surgical Gown	286
Non-Skid Shoe Cover.....	287
Smooth Bottom Shoe Cover	289
McKesson Bouffant Cap	289
Pro Series Bouffant Cap	289
Single-Ply Bouffant Cap	290
Surgeon Cap	291
Surgical Gown	292
CAUTERIES	293
Change-a-Tip Cautery	293
High-Temperature Cautery.....	294
Low-Temperature Cautery.....	294
Eye Bubble.....	295
SCALPELS & BLADES	295
BD Bard-Parker Scalpel Blade.....	295
Beaver Mini-Blade.....	296
Change-a-Blade Safety Scalpel Handle	296
Cincinnati Lance Blade.....	296
Cincinnati Surgical Blade Remover	297
Cincinnati Surgical Blade	297
Miltex General-Purpose Blade	298
Miniature Surgical Blade	298
Size 10 Disposable Scalpel	299
Size 11 Disposable Scalpel	299
Size 11 Safety Disposable Scalpel	300
Size 15 Disposable Scalpel	300
Size 15 Safety Disposable Scalpel	301
Size 21 Disposable Scalpel	301
Surgistar Handle and Blade	302
DRAPES	302
Adhesive Towel Drape.....	302
Aperture Drape.....	303
Aperture Pouch Drape.....	304
Convertors Mayo Stand Cover.....	304
Convertors Refractive Drape	304
Drape Cover	305
General-Purpose Drape	305
Incise Drape	307
Incise Drape with Pouch	308
Instrument Cover	309
Medi-Pak Performance Drape	309
Poly U Drape	309
Split Sheet Drape	310
Towel Drape	310
EYE SHIELDS	311
Blue Eye Shield.....	311
Clear Eye Shield	311
Gray Eye Shield	313

Metal Eye Shield.....	313
IRIS RETRACTORS.....	313
Disposable Iris Retractor.....	313
Reusable Iris Retractor.....	314
LIQUID BANDAGES.....	314
Histoacryl Topical Skin Adhesive.....	314
PVA PRODUCTS/WECK-CEL.....	315
Corneal Light Shield.....	315
Cellulose Eye Spear.....	315
PVA Eye Spear.....	315
LASIK PVA Disk.....	316
Ultracell Instrument Wipe.....	316
SURGICAL GLOVES.....	317
Derma Prene Ultra Surgical Gloves.....	317
Encore Acclaim Surgical Gloves.....	317
Encore Surgical Gloves.....	318
No Powder Surgical Gloves.....	318
Perry Performance Plus Micro-Thin Surgical Gloves.....	318
Perry Performance Plus Surgical Gloves.....	319
Sempermed Supreme Surgical Gloves.....	323
SensiCare Surgical Gloves.....	323
Sensi-Touch Surgical Gloves.....	324
Original Perry Style 42 Surgical Gloves.....	324
Triflex Surgical Gloves.....	325
Triumph Green Surgical Gloves.....	325
Triumph LT Surgical Gloves.....	325
SURGICAL LENSES.....	326
Bi-Concave Disposable Lens.....	326
Flat Disposable Lens.....	326
Flat SSV Disposable Lens.....	326
Magnifying Disposable Lens.....	327
Wide Field Disposable Lens.....	327
30-Degree Prism Disposable Lens.....	327
30-Degree Prism SSV ACS Lens.....	328

INSTRUMENT COVERS

PROTECTORS & GUARDS.....	330
Comply Instrument Protector.....	330
Osteotome Instrument Tip Guard.....	330
Round Instrument Tip Guard.....	330
Standard Instrument Tip Guard.....	331

CLEANING & STERILIZING

DIAMOND KNIFE CLEANING SYSTEMS.....	334
Opti-Kleen.....	334
INDICATOR STRIPS.....	334
Biological Indicator Incubator.....	334
Biological Indicator Test Pack.....	335
Biological Indicator Vial.....	335
Class 4 Steam Indicator Strip.....	337
Class 5 Steam Indicator Strip.....	338
Dry Heat Sterilization Indicator Strip.....	338
Indicator Label.....	338
OK Steam Sterilization Strip.....	339
Steam Indicator Tape.....	339
STERILIZATION POUCHES.....	340
Dry-Heat Sterilization Pouch.....	340
Steam Sterilization Pouch.....	340
ULTRASONIC CLEANERS.....	343
Crest 0.75-Gallon Ultrasonic Cleaner.....	343
Crest 2.5-Gallon Ultrasonic Cleaner.....	343
Crest 5-Gallon Ultrasonic Cleaner.....	343
QUICKRINSE INSTRUMENT RINSE SYSTEM.....	344
QuickRinse Cleaning System.....	344
CRYO UNITS	
CRYO UNITS.....	346
Keeler Cryomatic Cryo Unit.....	346

PRODUCT NUMBER LOOKUP

AccuSharp Disposable Ophthalmic Knives

NON-GUARDED DISPOSABLE OPHTHALMIC KNIVES

Item #	Description	Image
AccuSharp Ophthalmic Angled Slit Knife		
Disposable, single-use metal blades, ophthalmic angled slit knives with red handles. Comes with bevel up or double bevel options with a 45 degree angled tip. Packaged individually, sterile. Sold 6 per box.		
AB-ASLI0	1.0mm Angled Slit Knife 1.0mm wide tip, blade is bevel up.	
AB-ASLI2	1.2mm Angled Slit Knife 1.2mm wide tip, blade is bevel up.	
AB-ASLI8	1.8mm Angled Slit Knife 1.8mm wide tip, blade is bevel up.	
AB-ASLI8DB	1.8mm Angled Slit Knife 1.8mm wide tip, blade is double bevel.	
AB-ASL20	2.0mm Angled Slit Knife 2.0mm wide tip, blade is bevel up.	
AB-ASL22	2.2mm Angled Slit Knife 2.2mm wide tip, blade is bevel up.	
AB-ASL22DB	2.2mm Angled Slit Knife 2.2mm wide tip, blade is double bevel.	
AB-ASL23	2.3mm Angled Slit Knife 2.3mm wide tip, blade is bevel up.	
AB-ASL24	2.4mm Angled Slit Knife 2.4mm wide tip, blade is bevel up.	
AB-ASL24DB	2.4mm Angled Slit Knife 2.4mm wide tip, blade is double bevel.	
AB-ASL25	2.5mm Angled Slit Knife 2.5mm wide tip, blade is bevel up.	
AB-ASL25DB	2.5mm Angled Slit Knife 2.5mm wide tip, blade is double bevel.	
AB-ASL26	2.65mm Angled Slit Knife 2.65mm wide tip, blade is bevel up.	
AB-ASL26DB	2.65mm Angled Slit Knife 2.65mm wide tip, blade is double bevel.	
AB-ASL27	2.75mm Angled Slit Knife 2.75mm wide tip, blade is bevel up.	
AB-ASL27DB	2.75mm Angled Slit Knife 2.75mm wide tip, blade is double bevel.	
AB-ASL28	2.8mm Angled Slit Knife 2.8mm wide tip, blade is bevel up.	
AB-ASL28DB	2.8mm Angled Slit Knife 2.8mm wide tip, blade is double bevel.	
AB-ASL285	2.85mm Angled Slit Knife 2.85mm wide tip, blade is bevel up.	

NON-GUARDED DISPOSABLE OPHTHALMIC KNIVES

Item #	Description	Image
AB-ASL30	3.0mm Angled Slit Knife 3.0mm wide tip, blade is bevel up.	
AB-ASL30DB	3.0mm Angled Slit Knife 3.0mm wide tip, blade is double bevel.	
AB-ASL32	3.2mm Angled Slit Knife 3.2mm wide tip, blade is bevel up.	
AB-ASL32DB	3.2mm Angled Slit Knife 3.2mm wide tip, blade is double bevel.	
AB-ASL35	3.5mm Angled Slit Knife 3.5mm wide tip, blade is bevel up.	

AccuSharp Ophthalmic Straight Knife

Disposable, single-use metal blades, ophthalmic straight knives with pink handles. Blades are available in various degrees but all blades are double bevel. Packaged individually, sterile. Sold 6 per box.

AB-AST15	15-Degree Straight Knife 15-degree angled blade.
AB-AST22	22.5-Degree Straight Knife 22.5-degree angled blade.
AB-AST30	30-Degree Straight Knife 30-degree angled blade.
AB-AST45	45-Degree Straight Knife 45-degree angled blade.

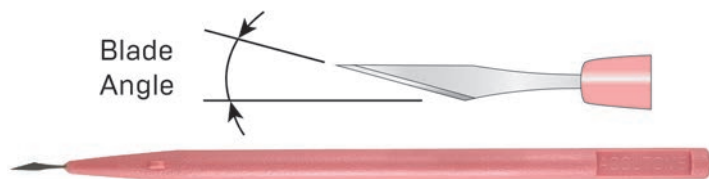

AccuSharp Ophthalmic Sideport/MVR Knife

Disposable, single-use metal blades, ophthalmic Sideport/MVR knives with green handles. Blades are available in various sizes and gauges with angled or straight shafts. Packaged individually, sterile. Sold 6 per box.

AB-AVR10	1.0mm Angled Sideport 1.0mm wide sideport blade with angled shaft.
AB-AVR10S	1.0mm Straight Sideport 1.0mm wide sideport blade with straight shaft.
AB-AVR12	1.2mm Angled Sideport 1.2mm wide sideport blade with angled shaft.
AB-AVR19	19 Gauge MVR Lance 19 gauge MVR blade with straight shaft.
AB-AVR19A	19 Gauge MVR Lance 19 gauge MVR blade with angled shaft.
AB-AVR20	20 Gauge MVR Lance 20 gauge MVR blade with straight shaft.
AB-AVR20A	20 Gauge MVR Lance 20 gauge MVR blade with angled shaft.
AB-AVR23A	23 Gauge MVR Lance 23 gauge MVR blade with angled shaft.
AB-AVR25	25 Gauge MVR Lance 25 gauge MVR blade with straight shaft.



NON-GUARDED DISPOSABLE OPHTHALMIC KNIVES

Item #	Description	Image
--------	-------------	-------

AccuSharp Ophthalmic Crescent Knife

Disposable, single-use metal blades, ophthalmic crescent knives with yellow handles. Crescent blades are rounded and measure 2.0mm in width. Blades are available with the bevel up or down and straight or angled. Packaged individually, sterile. Sold 6 per box.

AB-ACD26 **Angled Crescent Knife**
Blade is bevel down with 45-degree angled tip.

AB-ACS20 **Straight Crescent Knife**
Blade is bevel up with straight tip.

AB-ACU26 **Angled Crescent Knife**
Blade is bevel up with 45-degree angled tip.

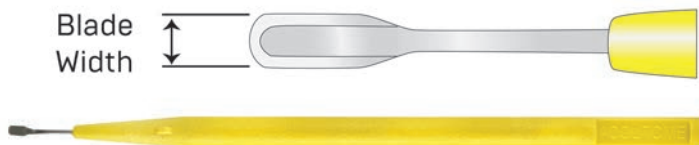

AccuSharp Ophthalmic Angled Implant Knife

Disposable, single-use metal blades, ophthalmic angled implant knives with blue handles. Blades are available in various widths and are bevel up with 45-degree angled tips. Packaged individually, sterile. Comes in a box of 6.

AB-ARS32 **3.2mm R Slit Knife**
3.2mm width blade.

AB-ARS35 **3.5mm R Slit Knife**
3.5mm width blade.

AB-ARS41 **4.1mm R Slit Knife**
4.1mm width blade.

AB-ARS52 **5.2mm R Slit Knife**
5.2mm width blade.

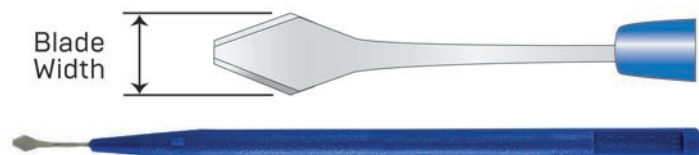

Stab Knife

Beaver-Visitec and Sharpoint brand disposable stab knife tips that screw into handles, handles not included. Blue in color with 15-degree angled tips. Sold 6 per box.

AXI4112 **Beaver-Visitec Micro-Sharp Blade**
Disposable 3.0mm restricted blade depth.



AX721502 **Sharpoint Stab Knife**
Sharpoint stab knives are heat-tempered to provide a strong, true point for easy penetration during initial stab incisions. Straight blade.



AX721532 **Sharpoint Stab Knife**
Sharpoint stab knives are heat-tempered to provide a strong, true point for easy penetration during initial stab incisions. 3.0mm straight restricted blade depth.



GUARDED DISPOSABLE OPHTHALMIC KNIVES

Item #	Description	Image
--------	-------------	-------

AccuSharp Guarded Ophthalmic Angled Slit Knife

Disposable, single-use metal blades, ophthalmic angled slit knives with blue handles. Handle has smooth, single handed blade retraction and has ergonomic design. Blades have superior sharpness and are available in various widths and bevel designs with 45-degree angled tips. Packaged individually, sterile. Sold 6 per box.

AB-ASL22G	2.2mm Guarded Angled Slit Knife 2.2mm blade width, bevel up.
AB-ASL24G	2.4mm Guarded Angled Slit Knife 2.4mm blade width, bevel up.
AB-ASL24DBG	2.4mm Guarded Angled Slit Knife 2.4mm blade width, double bevel.
AB-ASL25G	2.5mm Guarded Angled Slit Knife 2.5mm blade width, bevel up.
AB-ASL26G	2.65mm Guarded Angled Slit Knife 2.65mm blade width, bevel up.
AB-ASL27G	2.75mm Guarded Angled Slit Knife 2.75mm blade width, bevel up.
AB-ASL28G	2.8mm Guarded Angled Slit Knife 2.8mm blade width, bevel up.
AB-ASL30G	3.0mm Guarded Angled Slit Knife 3.0mm blade width, bevel up.
AB-ASL32G	3.2mm Guarded Angled Slit Knife 3.2mm blade width, bevel up.

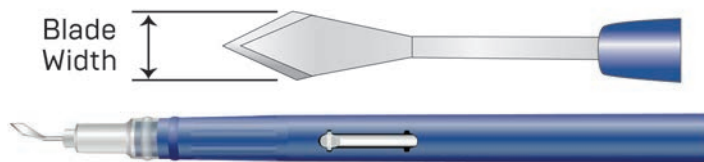

AccuSharp Guarded Ophthalmic Straight Knife

Disposable, single-use metal blades, ophthalmic straight knives with blue handles. Handle has smooth, single handed blade retraction and has ergonomic design. Blades have superior sharpness and are available in various angles and are double bevel. Packaged individually, sterile. Sold 6 per box.

AB-AST15G	15-Degree Guarded Straight Knife 15-degree angled blade, double bevel.
AB-AST22G	22.5-Degree Guarded Straight Knife 22.5-degree angled blade, double bevel.

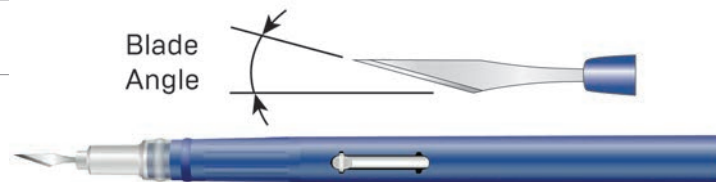

AccuSharp Guarded Ophthalmic Sideport/MVR Knife

Disposable, single-use metal blades, ophthalmic Sideport and MVR knives with blue handles. Handle has smooth, single handed blade retraction and has ergonomic design. Blades have superior sharpness and are available in various sizes and are straight or angled. Packaged individually, sterile. Sold 6 per box.

AB-AVR10AG	1.0mm Guarded Angled Sideport 1.0mm wide sideport blade with angled shaft.
AB-AVR19G	19 Gauge Guarded MVR Lance 19 gauge MVR blade with straight shaft.
AB-AVR19AG	19 Gauge Guarded MVR Lance 19 gauge MVR blade with angled shaft.
AB-AVR20G	20 Gauge Guarded MVR Lance 20 gauge MVR blade with straight shaft.



GUARDED DISPOSABLE OPHTHALMIC KNIVES

Item #	Description	Image
AB-AVR20AG	20 Gauge Guarded MVR Lance 20 gauge MVR blade with angled shaft.	
AB-AVR21G	21 Gauge Guarded MVR Lance 21 gauge MVR blade with straight shaft.	
AB-AVR21AG	21 Gauge Guarded MVR Lance 21 gauge MVR blade with angled shaft.	
AB-AVR23G	23 Gauge Guarded MVR Lance 23 gauge MVR blade with straight shaft.	
AB-AVR23AG	23 Gauge Guarded MVR Lance 23 gauge MVR blade with angled shaft.	
AB-AVR25G	25 Gauge Guarded MVR Lance 25 gauge MVR blade with straight shaft.	
AB-AVR25AG	25 Gauge Guarded MVR Lance 25 gauge MVR blade with angled shaft.	

AccuSharp Guarded Ophthalmic Crescent Knife

Disposable single-use metal blades, crescent knife, 2.0mm, bevel up, 45-degree angled tip. Blue handle with smooth, single handed blade retraction. Packaged individually, sterile. Sold 6 per box.

AB-ACU26G	2.0mm Guarded Crescent Knife	
-----------	-------------------------------------	--

AccuSharp Guarded Ophthalmic LRI Knife

Disposable, single-use metal blades, ophthalmic LRI knives with blue handles. Handle has smooth, single handed blade retraction and has ergonomic design. Blades have superior sharpness and are available in various preset incision depths with a 1.0mm blade width. Packaged individually, sterile. Sold 6 per box.

AB-ALRI500G	500 Micron Guarded LRI Knife 500 micron preset incision depth.	
AB-ALRI550G	550 Micron Guarded LRI Knife 550 micron preset incision depth.	
AB-ALRI600G	600 Micron Guarded LRI Knife 600 micron preset incision depth.	

Diamond Knives



On the Cutting Edge

Accutome's diamond knives are the perfect blend of design and craftsmanship, in order to make superior corneal incisions. With an in-house repair facility, Accutome is able to provide high-quality repairs and quick repair turnaround times. By owning it's own diamond-cutting facility, Accutome is able to offer a diamond knife exchange program, allowing you to upgrade or change blade designs as your incision needs change.

Features

- Unsurpassed sharpness
- Titanium and aluminum handles
- Lifetime warranty on titanium handles
- More cost effective than metal blades
- Variety of sizes and configurations available to fit your surgical needs

Please contact your Accutome sales representative at (800) 979.2020 or visit us on the web at www.accutome.com for additional information on our complete diamond knife product line.



PHACO INCISION DIAMOND KNIVES

Item #	Description	Image
Simplicity Series		
The Simplicity Series is the perfect blend of design and craftsmanship, helping make superior corneal incisions. The blade features a unique top and bottom bevel design, which creates a self-sealing incision without having to applanate or "dimple down". Various blade sizes available with four sharp sides. Handle is 100% titanium with J-locking mechanism and angled blade holder.		
AK6419	2.2mm Clear Cornea Blade 2.2mm blade width.	
AK6424	2.4mm Clear Cornea Blade 2.4mm blade width.	
AK6415	2.5mm Clear Cornea Blade 2.5mm blade width.	
AK6410	2.65mm Clear Cornea Blade 2.65mm blade width.	
AK6427	2.75mm Clear Cornea Blade 2.75mm blade width.	
AK6411	2.8mm Clear Cornea Blade 2.8mm blade width.	
AK6412	3.0mm Clear Cornea Blade 3.0mm blade width.	
AK6413	3.2mm Clear Cornea Blade 3.2mm blade width.	

Simplicity Trapezoid Series

The Simplicity Trapezoid Series is the perfect blend of design and craftsmanship, helping make superior corneal incisions. It features a blade with a unique top and bottom bevel design, which creates a self-sealing incision without having to applanate or "dimple down". Four sharp sided, trapezoid shaped blades with two different blade widths allowing for a small or large incision. Handle is 100% titanium with J-locking mechanism and angled blade holder.

AK6449	2.2mm/2.4mm Trapezoid Blade 2.2mm width at front of blade (width 1) and 2.4mm width blade at back of blade (width 2).	
AK6450	2.5mm/2.8mm Trapezoid Blade 2.5mm width at front of blade (width 1) and 2.8mm width blade at back of blade (width 2).	
AK6459	2.5mm/2.9mm Trapezoid Blade 2.5mm width at front of blade (width 1) and 2.9mm width blade at back of blade (width 2).	
AK6461	2.5mm/3.0mm Trapezoid Blade 2.5mm width at front of blade (width 1) and 3.0mm width blade at back of blade (width 2).	
AK6465	2.5mm/3.5mm Trapezoid Blade 2.5mm width at front of blade (width 1) and 3.5mm width blade at back of blade (width 2).	
AK6451	2.65mm/3.0mm Trapezoid Blade 2.65mm width at front of blade (width 1) and 3.0mm width blade at back of blade (width 2).	

PHACO INCISION DIAMOND KNIVES

Item #	Description	Image
AK6452	2.7mm/3.2mm Trapezoid Blade 2.7mm width at front of blade (width 1) and 3.2mm width blade at back of blade (width 2).	
AK6453	2.8mm/3.0mm Trapezoid Blade 2.8mm width at front of blade (width 1) and 3.0mm width blade at back of blade (width 2).	
AK6458	2.8mm/3.2mm Trapezoid Blade 2.8mm width at front of blade (width 1) and 3.2mm width blade at back of blade (width 2).	
AK6454	3.0mm/3.2mm Trapezoid Blade 3.0mm width at front of blade (width 1) and 3.2mm width blade at back of blade (width 2).	
AK6455	3.0mm/3.5mm Trapezoid Blade 3.0mm width at front of blade (width 1) and 3.5mm width blade at back of blade (width 2).	
AK6456	3.2mm/3.5mm Trapezoid Blade 3.2mm width at front of blade (width 1) and 3.5mm width blade at back of blade (width 2).	

Dual Bevel Diamond Knife (Dual Sides Sharp)

The Dual Bevel series provides a great combination of performance and affordability. Every Accutome blade is manufactured to the highest quality and specifications inside of our Accutome facility. Various blade sizes available with two sharp sides. Handle is 100% titanium with J-locking mechanism and angled blade holder.

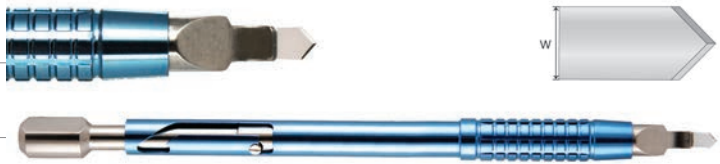
AK6007S	1.65mm Dual Bevel Blade 1.65mm blade width.	
AK6009S	2.2mm Dual Bevel Blade 2.2mm blade width.	
AK6023S	2.4mm Dual Bevel Blade 2.4mm blade width.	
AK6005-45	2.5mm Dual Bevel Blade 2.5mm blade width.	
AK6000-45	2.65mm Dual Bevel Blade 2.65mm blade width.	
AK6001-45	2.8mm Dual Bevel Blade 2.8mm blade width.	
AK6002-45	3.0mm Dual Bevel Blade 3.0mm blade width.	
AK6003-45	3.2mm Dual Bevel Blade 3.2mm blade width.	

PHACO INCISION DIAMOND KNIVES

Item #	Description	Image
Dual Bevel Diamond Knife (Four Sides Sharp)		
The Dual Bevel Series provides a great combination of performance and affordability. Every Accutome blade is manufactured to the highest quality and specifications inside of our Accutome facility. Various blade sizes available with four sharp sides. Handle is 100% titanium with J-locking mechanism and angled blade holder.		
AK6017S	1.65mm Dual Bevel Blade 1.65mm blade width.	
AK6021S	1.8mm Dual Bevel Blade 1.8mm blade width.	
AK6022S	2.0mm Dual Bevel Blade 2.0mm blade width.	
AK6019S	2.2mm Dual Bevel Blade 2.2mm blade width.	
AK6024S	2.4mm Dual Bevel Blade 2.4mm blade width.	
AK6015-45	2.5mm Dual Bevel Blade 2.5mm blade width.	
AK6010-45	2.65mm Dual Bevel Blade 2.65mm blade width.	
AK6011-45	2.8mm Dual Bevel Blade 2.8mm blade width.	
AK6012-45	3.0mm Dual Bevel Blade 3.0mm blade width.	
AK6013-45	3.2mm Dual Bevel Blade 3.2mm blade width.	

Dual Bevel Trapezoid Diamond Knife

The Dual Bevel series provides a great combination of performance and affordability. Every Accutome blade is manufactured to the highest quality and specifications inside of our Accutome facility. Four sharp sided, trapezoid shaped blades with two different blade widths allowing for a small or large incision. Handle is 100% titanium with J-locking mechanism and angled blade holder.

AK6047	1.2mm/1.4mm Trapezoid Blade 1.2mm width at front of blade (width 1) and 1.4mm width blade at back of blade (width 2).	
AK6072	2.0mm/2.2mm Trapezoid Blade 2.0mm width at front of blade (width 1) and 2.2mm width blade at back of blade (width 2).	
AK6070-60	2.2mm/2.5mm Trapezoid Blade 2.2mm width at front of blade (width 1) and 2.5mm width blade at back of blade (width 2).	
AK6050	2.5mm/2.8mm Trapezoid Blade 2.5mm width at front of blade (width 1) and 2.8mm width blade at back of blade (width 2).	

PHACO INCISION DIAMOND KNIVES

Item #	Description	Image
AK6059	2.5mm/2.9mm Trapezoid Blade 2.5mm width at front of blade (width 1) and 2.9mm width blade at back of blade (width 2).	
AK6064	2.5mm/3.0mm Trapezoid Blade 2.5mm width at front of blade (width 1) and 3.0mm width blade at back of blade (width 2).	
AK6060	2.5mm/3.2mm Trapezoid Blade 2.5mm width at front of blade (width 1) and 3.2mm width blade at back of blade (width 2).	
AK6065	2.5mm/3.5mm Trapezoid Blade 2.5mm width at front of blade (width 1) and 3.5mm width blade at back of blade (width 2).	
AK6051	2.65mm/3.0mm Trapezoid Blade 2.65mm width at front of blade (width 1) and 3.0mm width blade at back of blade (width 2).	
AK6052	2.7mm/3.2mm Trapezoid Blade 2.7mm width at front of blade (width 1) and 3.2mm width blade at back of blade (width 2).	
AK6053	2.8mm/3.0mm Trapezoid Blade 2.8mm width at front of blade (width 1) and 3.0mm width blade at back of blade (width 2).	
AK6058	2.8mm/3.2mm Trapezoid Blade 2.8mm width at front of blade (width 1) and 3.2mm width blade at back of blade (width 2).	
AK6067	2.8mm/3.5mm Trapezoid Blade 2.8mm width at front of blade (width 1) and 3.5mm width blade at back of blade (width 2).	
AK6054	3.0mm/3.2mm Trapezoid Blade 3.0mm width at front of blade (width 1) and 3.2mm width blade at back of blade (width 2).	

SPECIALTY DIAMOND KNIVES

Item #	Description	Image
Crescent Diamond Knife		
Accutome's Crescent blades are manufactured in-house, making it a high-quality product at an affordable price. Crescent blades have rounded blade tips that are available in various blade widths. Handle is 100% titanium with J-locking mechanism and angled blade holder.		
AK6044	1.0mm Crescent Blade 1.0mm blade width.	
AK6040	1.4mm Crescent Blade 1.4mm blade width.	
AK6041	2.0mm Crescent Blade 2.0mm blade width.	

SPECIALTY DIAMOND KNIVES

Item #	Description	Image
--------	-------------	-------

Sclerostomy Diamond Knife

Designed for implanting the Ex-Press filtration device. Blade measures 0.4mm in width and has two sharp sides. Handle is 100% titanium with J-locking mechanism and straight blade holder.

AK6180	Sclerostomy Lancet
--------	---------------------------



Universal Cataract Diamond Knife

Accutome's Universal Cataract diamond knives are manufactured in-house, making it a high-quality product at an affordable price. The Universal and Surgeon's Choice blades measure 1.0mm in width and have four sharp sides. Handle is 100% titanium with J-locking mechanism and straight blade holder.

AK6030	1.0mm Universal Blade No footplate, regular handle.
--------	---



AK6230-2	Dual Preset Surgeon's Choice Blade Footplate blade with step handle that has 0.3, 0.6, and full extension increments for increased versatility.
----------	---

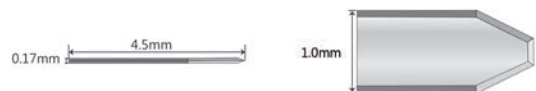

AK6230-3	Triple Preset Surgeon's Choice Blade Footplate blade with step handle that has 0.5, 0.55, 0.6, and full extension increments for increased versatility.
----------	---

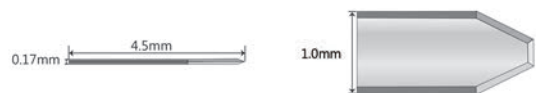

PARACENTESIS/STAB DIAMOND KNIVES

Item #	Description	Image
--------	-------------	-------

Hawkeye Series

Hawkeye Series knives are the most used knives in all of ophthalmic surgery. The Hawkeye Series provides great value and sharpness for paracentesis incisions. Every Accutome blade is manufactured to the highest quality and specifications inside of our Accutome facility. These lancet blades measure 1.0mm in width and come in various styles with either a straight or angled holder. Handle is aluminum with J-locking mechanism.

AK6130	0.7mm Truncated Lancet 0.7mm truncated lancet blade with straight holder.
--------	---



PARACENTESIS/STAB DIAMOND KNIVES

Item #	Description	Image
AK6I50	0.7mm Hawkeye Trifacet 0.7mm trifacet truncated lancet blade with straight holder.	
AK6I60	1.0mm Truncated Lancet 1.0mm truncated lancet blade with straight holder.	
AK6I60A	1.0mm Angled Truncated Lancet 1.0mm truncated lancet blade with angled holder.	
AK6I75	1.0mm Lancet 1.0mm lancet blade with straight holder.	
AK6I75A	1.0mm Angled Lancet 1.0mm lancet blade with angled holder.	

Hawkeye Premium Series

The Hawkeye Premium Series is manufactured in-house, making it a high-quality product at an affordable price. The blades measure 1.0mm in width and come in various styles. Handle is 100% titanium with J-locking mechanism and straight holders.

AK5015	1.0mm Trifacet Freehand Trifacet blade with two sides sharp.	
AK6026	45-Degree Single-Edge Freehand 45-degree blade with one side sharp.	
AK6016-60	1.0mm Clear Cornea Lancet Blade with four sides sharp.	

ASTIGMATISM MANAGEMENT DIAMOND KNIVES

Item #	Description	Image
Donnenfeld Preset LRI, Long Handle		
Please note that custom preset options are available. These long-handled preset Donnenfeld lancet blades are available in various desired preset specifications. Blades are at a 15-degree angle for better applanation, are 1.0mm in width, and have a winged footplate for superior control. Handle is 100% titanium and measures 4.5 inches long.		
AK6I75PT200	Donnenfeld Preset LRI, 200 Micron Lancet blade with 200 micron depth preset.	
AK6I75PT250	Donnenfeld Preset LRI, 250 Micron Lancet blade with 250 micron depth preset.	
AK6I75PT300	Donnenfeld Preset LRI, 300 Micron Lancet blade with 300 micron depth preset.	
AK6I75PT350	Donnenfeld Preset LRI, 350 Micron Lancet blade with 350 micron depth preset.	
AK6I75PT400	Donnenfeld Preset LRI, 400 Micron Lancet blade with 400 micron depth preset.	
AK6I75PT450	Donnenfeld Preset LRI, 450 Micron Lancet blade with 450 micron depth preset.	
AK6I75PT500	Donnenfeld Preset LRI, 500 Micron Lancet blade with 500 micron depth preset.	
AK6I75PT550	Donnenfeld Preset LRI, 550 Micron Lancet blade with 550 micron depth preset.	
AK6I75PT600	Donnenfeld Preset LRI, 600 Micron Lancet blade with 600 micron depth preset.	

Donnenfeld Preset LRI, Short Handle

Please note that custom preset options are available. These short-handled preset Donnenfeld lancet blades are available in various desired preset specifications. Blades are at a 15-degree angle for better applanation, are 1.0mm in width, and have a winged footplate for superior control. Handle is 100% titanium and measures 2.625 inches long.

AK6I75SPT200	Donnenfeld Preset LRI, 200 Micron Lancet blade with 200 micron depth preset.	
AK6I75SPT250	Donnenfeld Preset LRI, 250 Micron Lancet blade with 250 micron depth preset.	
AK6I75SPT300	Donnenfeld Preset LRI, 300 Micron Lancet blade with 300 micron depth preset.	
AK6I75SPT350	Donnenfeld Preset LRI, 350 Micron Lancet blade with 350 micron depth preset.	
AK6I75SPT400	Donnenfeld Preset LRI, 400 Micron Lancet blade with 400 micron depth preset.	
AK6I75SPT450	Donnenfeld Preset LRI, 450 Micron Lancet blade with 450 micron depth preset.	
AK6I75SPT500	Donnenfeld Preset LRI, 500 Micron Lancet blade with 500 micron depth preset.	
AK6I75SPT550	Donnenfeld Preset LRI, 550 Micron Lancet blade with 550 micron depth preset.	
AK6I75SPT600	Donnenfeld Preset LRI, 600 Micron Lancet blade with 600 micron depth preset.	

ASTIGMATISM MANAGEMENT DIAMOND KNIVES

Item #	Description	Image
Donnenfeld Preset Truncated Lancet, Long Handle		
Please note that custom preset options are available. These long-handled preset Donnenfeld truncated lancet blades are available in various desired preset specifications. Blades are at a 15-degree angle for better appplanation, are 1.0mm in width, and have a winged footplate for superior control. Handle is 100% titanium and measures 4.5 inches long.		
AK6I60PT200	Donnenfeld Preset Truncated Lancet, 200 Micron Truncated lancet blade with 200 micron depth preset.	
AK6I60PT250	Donnenfeld Preset Truncated Lancet, 250 Micron Truncated lancet blade with 250 micron depth preset.	
AK6I60PT300	Donnenfeld Preset Truncated Lancet, 300 Micron Truncated lancet blade with 300 micron depth preset.	
AK6I60PT350	Donnenfeld Preset Truncated Lancet, 350 Micron Truncated lancet blade with 350 micron depth preset.	
AK6I60PT400	Donnenfeld Preset Truncated Lancet, 400 Micron Truncated lancet blade with 400 micron depth preset.	
AK6I60PT450	Donnenfeld Preset Truncated Lancet, 450 Micron Truncated lancet blade with 450 micron depth preset.	
AK6I60PT500	Donnenfeld Preset Truncated Lancet, 500 Micron Truncated lancet blade with 500 micron depth preset.	
AK6I60PT550	Donnenfeld Preset Truncated Lancet, 550 Micron Truncated lancet blade with 550 micron depth preset.	
AK6I60PT600	Donnenfeld Preset Truncated Lancet, 600 Micron Truncated lancet blade with 600 micron depth preset.	

Donnenfeld Preset Truncated Lancet, Short Handle

Please note that custom preset options are available. These short-handled preset Donnenfeld truncated lancet blades are available in various desired preset specifications. Blades are at a 15-degree angle for better appplanation, are 1.0mm in width, and have a winged footplate for superior control. Handle is 100% titanium and measures 2.625 inches long.

AK6I60SPT200	Donnenfeld Preset Truncated Lancet, 200 Micron Truncated lancet blade with 200 micron depth preset.	
AK6I60SPT250	Donnenfeld Preset Truncated Lancet, 250 Micron Truncated lancet blade with 250 micron depth preset.	
AK6I60SPT300	Donnenfeld Preset Truncated Lancet, 300 Micron Truncated lancet blade with 300 micron depth preset.	
AK6I60SPT350	Donnenfeld Preset Truncated Lancet, 350 Micron Truncated lancet blade with 350 micron depth preset.	
AK6I60SPT400	Donnenfeld Preset Truncated Lancet, 400 Micron Truncated lancet blade with 400 micron depth preset.	
AK6I60SPT450	Donnenfeld Preset Truncated Lancet, 450 Micron Truncated lancet blade with 450 micron depth preset.	
AK6I60SPT500	Donnenfeld Preset Truncated Lancet, 500 Micron Truncated lancet blade with 500 micron depth preset.	
AK6I60SPT550	Donnenfeld Preset Truncated Lancet, 550 Micron Truncated lancet blade with 550 micron depth preset.	
AK6I60SPT600	Donnenfeld Preset Truncated Lancet, 600 Micron Truncated lancet blade with 600 micron depth preset.	

ASTIGMATISM MANAGEMENT DIAMOND KNIVES

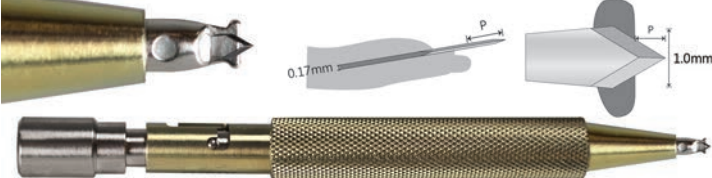
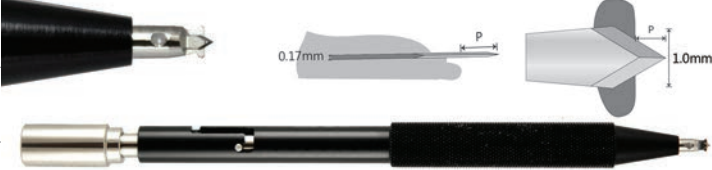
Item #	Description	Image
Chang LRI Diamond Knife		
<p>A 1.0mm wide lancet blade developed specifically for correcting astigmatism using an intraoperative wavefront aberrometer. Customized, 3.5-inch, gold, aluminum, straight handle design to provide better control within shorter working distance. Winged footplate provides superior visualization and reduces epithelium drag. Highest quality preset diamond blade. Fully retractable J-locking mechanism for blade and sharps protection.</p>		
AK6I75PC	Chang LRI Diamond Knife	 <p>The image shows the Chang LRI Diamond Knife, a gold-colored instrument with a textured handle. To the right are technical diagrams of the blade tip: a side view showing a 0.17mm thickness and a top view showing a 1.0mm width. The diagrams include labels 'P' and 'H' indicating specific dimensions.</p>
Rubenstein Preset LRI, Long Handle		
<p>Please note that custom preset options are available. These long-handed Rubenstein Preset LRI lancet diamond knives measure 1.0mm in width and are available in various desired preset specifications. Winged footplate for superior control. Handle is straight aluminum and measures 4.75 inches long.</p>		
AK6I75P200	Rubenstein Preset LRI, 200 Micron	 <p>The image shows the Rubenstein Preset LRI, Long Handle diamond knives, which have a black handle and a gold-colored blade. To the right are technical diagrams of the blade tip, identical to the ones shown for the Chang LRI Diamond Knife, with a 0.17mm thickness and a 1.0mm width. Labels 'P' and 'H' are present in the diagrams.</p>
Lancet blade with 200 micron depth preset.		
AK6I75P250	Rubenstein Preset LRI, 250 Micron	
Lancet blade with 250 micron depth preset.		
AK6I75P300	Rubenstein Preset LRI, 300 Micron	
Lancet blade with 300 micron depth preset.		
AK6I75P350	Rubenstein Preset LRI, 350 Micron	
Lancet blade with 350 micron depth preset.		
AK6I75P400	Rubenstein Preset LRI, 400 Micron	
Lancet blade with 400 micron depth preset.		
AK6I75P450	Rubenstein Preset LRI, 450 Micron	
Lancet blade with 450 micron depth preset.		
AK6I75P500	Rubenstein Preset LRI, 500 Micron	
Lancet blade with 500 micron depth preset.		
AK6I75P550	Rubenstein Preset LRI, 550 Micron	
Lancet blade with 550 micron depth preset.		
AK6I75P600	Rubenstein Preset LRI, 600 Micron	
Lancet blade with 600 micron depth preset.		

ASTIGMATISM MANAGEMENT DIAMOND KNIVES

Item #	Description	Image
Rubenstein Preset Truncated Lancet, Long Handle		
Please note that custom preset options are available. These long-handled Rubenstein Preset truncated lancet diamond knives measure 1.0mm in width and are available in various desired preset specifications. Winged footplate for superior control. Handle is straight aluminum and measures 4.75 inches long.		
AK6I60P200	Rubenstein Preset Truncated Lancet, 200 Micron Truncated lancet blade with 200 micron depth preset.	
AK6I60P250	Rubenstein Preset Truncated Lancet, 250 Micron Truncated lancet blade with 250 micron depth preset.	
AK6I60P300	Rubenstein Preset Truncated Lancet, 300 Micron Truncated lancet blade with 300 micron depth preset.	
AK6I60P350	Rubenstein Preset Truncated Lancet, 350 Micron Truncated lancet blade with 350 micron depth preset.	
AK6I60P400	Rubenstein Preset Truncated Lancet, 400 Micron Truncated lancet blade with 400 micron depth preset.	
AK6I60P450	Rubenstein Preset Truncated Lancet, 450 Micron Truncated lancet blade with 450 micron depth preset.	
AK6I60P500	Rubenstein Preset Truncated Lancet, 500 Micron Truncated lancet blade with 500 micron depth preset.	
AK6I60P550	Rubenstein Preset Truncated Lancet, 550 Micron Truncated lancet blade with 550 micron depth preset.	
AK6I60P600	Rubenstein Preset Truncated Lancet, 600 Micron Truncated lancet blade with 600 micron depth preset.	

Rubenstein Preset LRI, Short Handle

Please note that custom preset options are available. These short-handled Rubenstein Preset LRI lancet diamond knives measure 1.0mm in width and are available in various desired preset specifications. Winged footplate for superior control. Handle is straight aluminum and measures 2.75 inches long.

AK6I75SP200	Rubenstein Preset LRI, 200 Micron Lancet blade with 200 micron depth preset.	
AK6I75SP250	Rubenstein Preset LRI, 250 Micron Lancet blade with 250 micron depth preset.	
AK6I75SP300	Rubenstein Preset LRI, 300 Micron Lancet blade with 300 micron depth preset.	
AK6I75SP350	Rubenstein Preset LRI, 350 Micron Lancet blade with 350 micron depth preset.	
AK6I75SP400	Rubenstein Preset LRI, 400 Micron Lancet blade with 400 micron depth preset.	
AK6I75SP450	Rubenstein Preset LRI, 450 Micron Lancet blade with 450 micron depth preset.	
AK6I75SP500	Rubenstein Preset LRI, 500 Micron Lancet blade with 500 micron depth preset.	
AK6I75SP550	Rubenstein Preset LRI, 550 Micron Lancet blade with 550 micron depth preset.	

ASTIGMATISM MANAGEMENT DIAMOND KNIVES

Item #	Description	Image
AK6175SP600	Rubenstein Preset LRI, 600 Micron Lancet blade with 600 micron depth preset.	

Surgeon's Choice Adjustable

Please note that any diamond knife orders will be processed as separate orders in house. Other pre-set options are available upon request. Blade with various adjustable pre-set handle steps. Blade measures 1.0mm in width and each knife has a wide footplate design. Handle is 100% titanium and has a straight holder.



AK6216	1.0mm Clear Cornea Blade Clear cornea blade with adjustable steps - 0.5mm, 0.55mm, 0.6mm, and full extension.	
AK6235-2	1.0mm Double Preset Lancet Blade Lancet blade with two pre-set adjustable steps - 0.3mm and 0.6mm.	
AK6235-3	1.0mm Triple Preset Lancet Blade Lancet blade with three preset adjustable steps - 0.5mm, 0.55mm, and 0.6mm.	

Micrometer

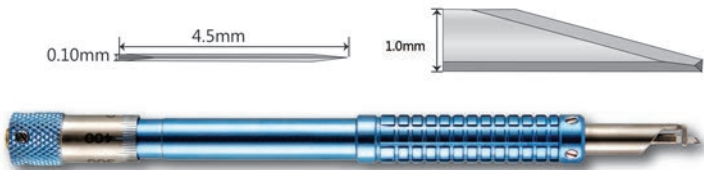
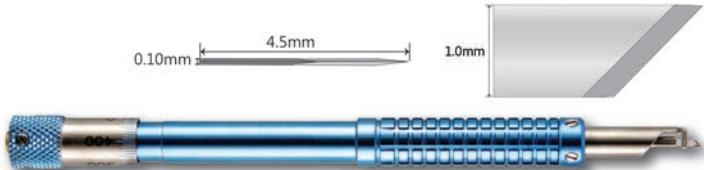
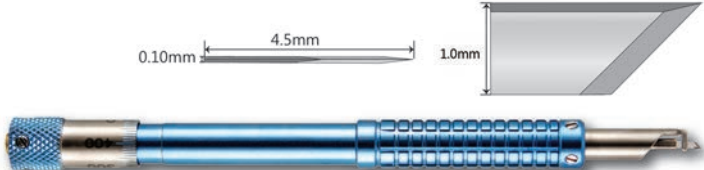
Variety of 1.0mm blade styles mounted in an adjustable micrometer handle. Dual footplate for superior control. 100% titanium handle.

AK5003	15-Degree Micrometer 15-Degree Arcuate Blade mounted in an adjustable micrometer handle.	
AK5002	45-Degree Micrometer Single edge, 45-degree RK Blade mounted in an adjustable micrometer handle.	
AK5005	45-Degree Micrometer Double edge, 45-degree blade mounted in an adjustable micrometer handle.	

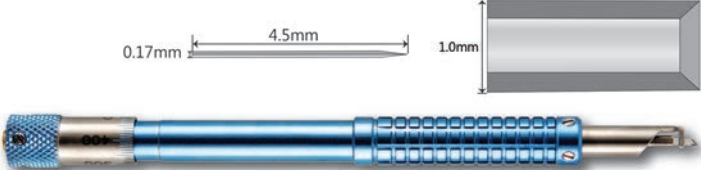
ASTIGMATISM MANAGEMENT DIAMOND KNIVES

Item #	Description	Image
AK5004	<p data-bbox="261 323 467 344">Tri-Square Micrometer</p> <p data-bbox="261 359 727 401">Tri-Square (Triple 90) Blade mounted in an adjustable micrometer handle.</p>	 <p>The image shows the AK5004 Tri-Square Micrometer. It consists of a blue adjustable micrometer handle and a diamond blade. The blade is shown in a side view with dimensions: a width of 0.17mm, a length of 4.5mm, and a thickness of 1.0mm. The handle has a knurled grip and a scale.</p>
AK5017	<p data-bbox="261 516 448 537">Triple 90 Micrometer</p> <p data-bbox="261 552 727 594">Tri-Square (Triple 90) Blade mounted in an adjustable micrometer handle. 250 micron cutting depth.</p>	 <p>The image shows the AK5017 Triple 90 Micrometer. It consists of a blue adjustable micrometer handle and a diamond blade. The blade is shown in a side view with dimensions: a width of 0.17mm, a length of 4.5mm, and a thickness of 1.0mm. The handle has a knurled grip and a scale. The blade has a cutting depth of 250 microns. The handle is marked with '400', '7', and 'ACCUHOME USA CE'.</p>

Sapphire Knives



KERATOME SAPPHIRE KNIVES

Item #	Description	Image
Clear Cornea Sapphire Knife		
Variety of sapphire blade widths. Aluminum handle with J-locking mechanism and angled holder.		
AK0018L	1.5mm Clear Cornea Sapphire 1.5mm wide clear cornea blade.	
AK0019L	2.2mm Clear Cornea Sapphire 2.2mm wide clear cornea blade.	
AK0011L	2.8mm Clear Cornea Sapphire 2.8mm wide clear cornea blade.	
AK0012L	3.0mm Clear Cornea Sapphire 3.0mm wide clear cornea blade.	
AK0013L	3.2mm Clear Cornea Sapphire 3.2mm wide clear cornea blade.	
Spear Sapphire Knife		
Variety of sapphire blade widths. Aluminum handle with J-locking mechanism and angled holder.		
AK0001L	2.8mm Lance Sapphire Knife 2.8mm wide spear blade.	
AK0002L	3.0mm Lance Sapphire Knife 3.0mm wide spear blade.	
AK0003L	3.2mm Lance Sapphire Knife 3.2mm wide spear blade.	
Trapezoid Sapphire Knife		
Four sharp-sided, trapezoid-shaped blades with two different blade widths allowing for a small or large incision. Aluminum handle with J-locking mechanism and angled holder.		
AK0038	0.9mm/1.2mm Trapezoid Sapphire 0.9mm width at front of blade (width 1) and 1.2mm width blade at back of blade (width 2).	
AK0025	2.2mm/2.5mm Trapezoid Sapphire 2.2mm width at front of blade (width 1) and 2.5mm width blade at back of blade (width 2).	
AK0061	2.5mm/3.0mm Trapezoid Sapphire 2.5mm width at front of blade (width 1) and 3.0mm width blade at back of blade (width 2).	
AK0060	2.5mm/3.2mm Trapezoid Sapphire 2.5mm width at front of blade (width 1) and 3.2mm width blade at back of blade (width 2).	

CRESCENT SAPPHIRE KNIVES

Item #	Description	Image
--------	-------------	-------

Crescent Sapphire Knife

2.0mm crescent blade. Aluminum handle with J-locking mechanism. Angled holder.

AK0041	2.0mm Crescent Sapphire	
--------	---	--

SAPPHIRE STAB KNIVES

Item #	Description	Image
--------	-------------	-------

Lancet Sapphire Knife

1.0mm lance blade. Aluminum handle with J-locking mechanism. Straight holder.

AK0035	1.0mm Lance Sapphire	
--------	--------------------------------------	---

Single-Edge Sapphire Knife

1.0mm single-edge blade. Aluminum handle with J-locking mechanism. Straight holder.

AK0009	1.0mm Single-Edge Sapphire	
--------	--	--

Trifacet Sapphire Knife

1.0mm trifacet blade. Aluminum handle with J-locking mechanism. Straight holder.

AK0010	1.0mm Trifacet Sapphire	
--------	---	--

We Have You Covered

Accutome provides a wide range of repair services including: Phaco Handpiece, Handheld Instrument, and Diamond Knives (all brands and all styles). Accutome can also repair a long list of ultrasound equipment. Our experienced staff provides quality, professional service utilizing technologically advanced in-house repair facilities.

Specific Repair Services Include:

Phaco Handpiece Repair

- Servicing all major brands, with 6- or 12-month warranty, 5-day repair turnaround.
- Refurbished handpieces available in most makes and models.

Diamond Knife Repair

- Any size and any style knife can be repaired, usually within 24 hours. We will refurbish your old handles when your diamond blades are repaired.
- Diamond Exchange Program allows you to upgrade or change blade designs and sizes as your incisional needs change. Accutome will replace the older blade in your diamond knife with a new state-of-the-art Clear Cornea, Simplicity one pass, or Phaco blade for the price of a repair.
- Exact Size Guarantee within 60 days of a diamond knife purchase, Accutome adjusts diamond widths at no extra charge should the surgeon require a larger or smaller incision.

Instrument Repair

- Any handheld surgical instrument can be repaired.
- Forceps – straightening, aligning, and remanufacturing forceps teeth.
- Scissors – sharpening and refurbishing
- Hooks and manipulators
- Needle holders
- Speculums

Handpieces

- Most makes and models

Camera Repair

Servicing many brands, including:

- Stryker
- Storz
- Dyonics
- Olympus
- Linvatec

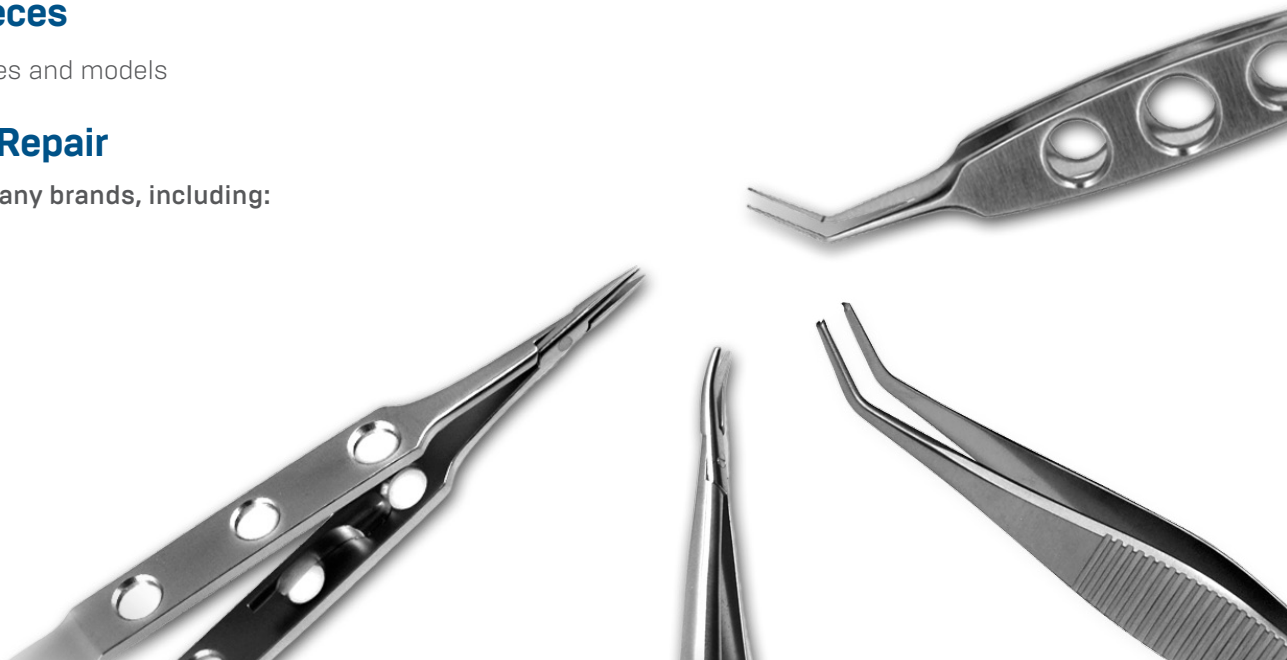

Bipolar Instruments

BIPOLAR CABLES & PROBES

Item #	Description	Image
--------	-------------	-------

Bipolar Cables

Reusable TPR (thermoplastic rubber) bipolar cables 12 inches, straight connection, universal 2 pin fitting. Fits 4mm banana-plug style generators. Good for use with steam sterilization.

AM0830	<p>Straight Bipolar Cable Straight connector.</p>	
--------	--	--

AM0831	<p>Angled Bipolar Cable 45-degree connector.</p>	
--------	---	---

Cautery Probe

Straight tip. Reusable.

AF0160	<p>Cautery Probe 18g 18 gauge probe.</p>	
AF0162	<p>Cautery Probe 20g 20 gauge probe.</p>	

BIPOLAR FORCEPS



Item #	Description	Image
--------	-------------	-------

Adson Bipolar Forceps

Straight shafts, 1.0mm wide tips. Flat handle. Overall length: 127mm.

AF0125	<p>Adson Bipolar Forceps, Straight 1.0mm wide serrated tips. Insulated handle. Overall length: 127mm.</p>	
AF0127	<p>Adson Bipolar Forceps, Straight 1.0mm wide non-stick tips. Overall length: 127mm.</p>	

BIPOLAR FORCEPS

Item #	Description	Image
Coaptation Bipolar Forceps		
Curved shafts, angled 0.6mm wide non-stick tips, wide, flat handle. Non-insulated. Overall length: 114mm.		
AF0100	Coaptation Bipolar Forceps	
Jewelers Bipolar Forceps		
Straight shafts with fine pointed tips. Smooth handle with dull finish. Overall length: 120mm.		
AF0120	Non-insulated Jewelers Bipolar Forceps Non-insulated.	
AF0120 IN	Insulated Jewelers Bipolar Forceps Insulated.	
McPherson Bipolar Forceps		
Straight and angled shafts, 0.4mm wide non-stick tips. Flat handle. Overall length: 95mm.		
AF0130	McPherson Bipolar Forceps, Angled Angled shafts, non-insulated.	
AF0130 I	McPherson Bipolar Forceps, Angled Angled shafts, insulated.	
AF0140	McPherson Bipolar Forceps, Straight Straight shafts, non-insulated.	

BIPOlar FORCEPS

Item #	Description	Image
Shepard Bipolar Forceps		
Angled shafts with 4mm platform. Smooth handle with dull finish. Non-insulated. Overall length: 120mm.		
AF0145 A	Shepard Bipolar Forceps	

Calipers, Gauges & Markers

CALIPERS

Item #	Description	Image
--------	-------------	-------

Braunstein Fixed Caliper

Aphakic: 3.5mm. Phakic: 4mm. Overall length: 80mm.

AR0155	Braunstein Fixed Caliper
--------	--



Castroviejo Caliper

Measures 0mm-20mm in 1.0mm increments. Screw-locking mechanism. Overall length: 89mm.

AR0140	Castroviejo Caliper Curved blades.
--------	---



AR0150	Castroviejo Caliper Straight blades.
--------	---



AR0150T1	Castroviejo Caliper Straight titanium blades.
----------	--



Jameson Caliper

Angled tips, measures 0mm to 80mm with 1.0mm increments. Overall length: 95mm.

AR0260	Jameson Caliper
--------	---------------------------------



CALIPERS

Item #	Description	Image
--------	-------------	-------

Stahl Corneal Caliper

Measures 10-13mm in 0.5mm increments.

AR0380	Stahl Caliper	
--------	-------------------------------	--

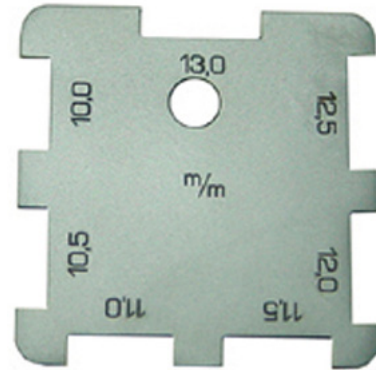

GAUGES

Item #	Description	Image
--------	-------------	-------

Mendez Degree Gauge

Outside diameter 18mm. Inside diameter 12mm. Markings on top of instrument, 10-degree increments. Round handle. Overall length: 114mm.

AR0121	Stainless Steel Gauge Made from stainless steel.	
--------	---	--



AR0121TI	Titanium Gauge Made from titanium.	
----------	---	--



MARKERS

Item #	Description	Image
--------	-------------	-------





Bores Axis Marker

Designed to fit inside of degree gauge for axis marking. Round handle.

AR0120	Bores Axis Marker	
--------	-----------------------------------	--



MARKERS

Item #	Description	Image
Chayet Marker		
<p>Stainless steel corneal marker that is to be used during LASIK surgery for identifying and realigning the lamellar flap. Marking pattern uses a small, medium, and large circle. Flat handle. Overall length: 106mm.</p>		
AR4120	Chayet Marker	
Dell LRI Astigmatism Marker		
<p>Titanium with axis marking blades. Rotating ring with 10 degree increments. Round, knurled handle. Overall length: 120mm.</p>		
AR0126	<p>Gills Nomogram Marker 6mm and 8mm chord length and axis marking blades.</p>	
AR0127	<p>Nichamin Nomogram Marker 40, 60, 80 degrees and axis marking blades.</p>	
AR0129	<p>Nichamin Nomogram Marker 40, 60, 80 degrees and axis marking blades. Reference marks for proper positioning.</p>	
AR0132	<p>Donnenfeld LRI Marker 1, 2 clock hours (30, 60 degrees) and axis marking blades.</p>	

MARKERS

Item #	Description	Image
--------	-------------	-------

Devgan Axis Marker

The Devgan Axis Markers are designed to improve toric IOL axis and centration accuracy for better outcomes. The marking blades fit most standard goldman tonometer housings. Hollow center allows surgeon to center marks with pupil without the use of gentian violet ink. Markers are 6mm or 9mm on the inside of the blades and 9 to 12mm on the outside. Markers are either smooth and angled or pointed and angled. Marks 0 to 180 degrees in 10-degree increments.

AR8000 **6-9mm Marking Blade**
 Marking blades are 6mm apart on the inside and 9mm apart on the outside. Tips of marker are smooth and angled.

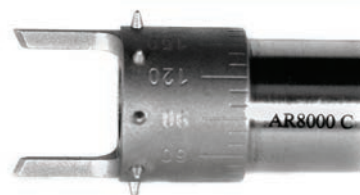
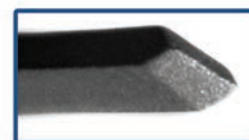

AR8001 **9-12mm Marking Blade**
 Marking blades are 9mm apart on the inside and 12mm apart on the outside. Tips of marker are smooth and angled.

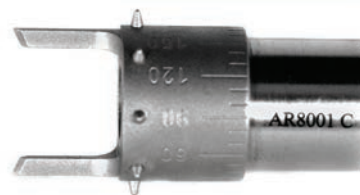
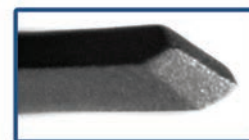

AR8002 **6-9mm Marking Blade**
 Marking blades are 6mm apart on the inside and 9mm apart on the outside. Tips of marker have three points and are angled. This tip will leave three dots on each side and is used for toric IOL marking.

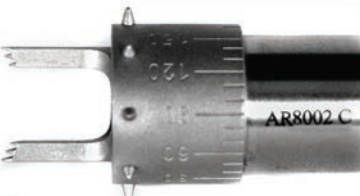

Hoffer Optical Zone Marker

Various marker diameters with cross hairs. Round handle. Overall length: 108mm.

AR0250 4.00 **4mm Optical Zone Marker**
 4.0mm diameter with cross hairs.

AR0250 4.50 **4.5mm Optical Zone Marker**
 4.5mm diameter with cross hairs.

AR0250 5.00 **5.0mm Optical Zone Marker**
 5.0mm diameter with cross hairs.



MARKERS

Item #	Description	Image
AR0250 5.50	5.5mm Optical Zone Marker 5.5mm diameter with cross hairs.	
AR0250 5.75	5.75mm Optical Zone Marker 5.75mm diameter with cross hairs.	
AR0250 6.00	6.0mm Optical Zone Marker 6.0mm diameter with cross hairs.	
AR0250 8.00	8.0mm Optical Zone Marker 8.0mm diameter with cross hairs.	
AR0250 8.5	8.5mm Optical Zone Marker 8.5mm diameter with cross hairs.	
AR0250 9.00	9.0mm Optical Zone Marker 9.0mm diameter with cross hairs.	

LASIK Corneal Marker

Three marking blades. Round handle.

AR4130	LASIK Corneal Marker	
--------	-----------------------------	---

Osher-Neumann Radial Incision Marker

Marking blades, low profile. Round handle.

AR0400 8	Osher-Neumann Radial Marker 8 marking blades.	
AR0400 12	Osher-Neumann Radial Marker 12 marking blades.	

MARKERS

Item #	Description	Image
Plain Optical Zone Marker		
Open circle tip with various diameter sizes and low profile design. Round Handle. Overall length: 95mm.		
AR0370 2.50	2.5mm Optical Zone Marker 2.5mm diameter.	
AR0370 3.00	3.0mm Optical Zone Marker 3.0mm diameter.	
AR0370 3.50	3.5mm Optical Zone Marker 3.5mm diameter.	
AR0370 4.00	4.0mm Optical Zone Marker 4.0mm diameter.	
AR0370 5.00	5.0mm Optical Zone Marker 5.0mm diameter.	
AR0370 5.75	5.75mm Optical Zone Marker 5.75mm diameter.	
AR0370 6.00	6.0mm Optical Zone Marker 6.0mm diameter.	
AR0370 7.00	7.0mm Optical Zone Marker 7.0mm diameter.	
AR0370 8.00	8.0mm Optical Zone Marker 8.0mm diameter.	
AR0370 9.00	9.0mm Optical Zone Marker 9.0mm diameter.	

Rubenstein LASIK Corneal Marker		
Five marking blades. Flat handle.		
AR4150	Rubenstein LASIK Corneal Marker	

Toric Lens Marker		
Titanium. Axis marking blades. Rotating ring with 10-degree increments. Round, knurled handle.		
AR0146	Toric Lens Marker Overall length: 127mm.	
AR0148	Toric Lens Marker Overall length: 120mm.	

MARKERS

Item #	Description	Image
Toric Reference Marker		
Three marking blades at 0, 90, and 180 degrees. 15mm diameter. Designed for marking with patient in the upright position.		
AR0145	Toric Reference Marker	

Cannulas & Cystotomes

ACCUSURGICAL SINGLE-USE CANNULAS & CYSTOTOMES

Item #	Description	Image
--------	-------------	-------

Atkinson Retrobulbar Needle

The Atkinson Retrobulbar Needle has a straight shaft and needle tip. Disposable, sold 10 per box. Overall length: 38mm.

AXI0414	Retrobulbar Needle, 23g 23 gauge.
AXIII637	Retrobulbar Needle, 25g 25 gauge.
AXI4571	Retrobulbar Needle, 27g 27 gauge.

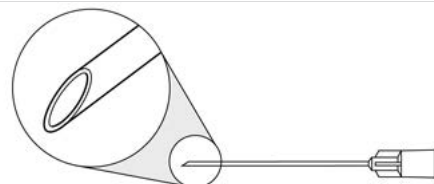

Atkinson Peribulbar Needle

The AccuSurgical disposable Atkinson Peribulbar Needle has a straight shaft and needle tip. Available between 16mm and 32mm total length and 23 to 27 gauge. Sold 10 per box.

AXI4576	Peribulbar Needle, 23g 23 gauge. Overall length: 16mm.
AXI4577	Peribulbar Needle, 23g 23 gauge. Overall length: 22mm.
AXI0853	Peribulbar Needle, 23g 23 gauge. Overall length: 32mm.
AXI4572	Peribulbar Needle, 25g 25 gauge. Overall length: 16mm.
AXII5027	Peribulbar Needle, 25g 25 gauge. Overall length: 22mm.
AXIII642	Peribulbar Needle, 25g 25 gauge. Overall length: 32mm.
AXI4568	Peribulbar Needle, 27g 27 gauge. Overall length: 22mm.
AXI2045	Peribulbar Needle, 27g 27 gauge. Overall length: 32mm.



Non Atkinson Retrobulbar Needle

The AccuSurgical disposable Non Atkinson Retrobulbar Needle has a straight shaft and needle tip. Available between 25 to 27 gauge with an overall length of 38mm. Sold 10 per box.

AXI4580	Non Atkinson Retrobulbar Needle, 25g 25 gauge.
AXI4581	Non Atkinson Retrobulbar Needle, 26g 26 gauge.
AXI4582	Non Atkinson Retrobulbar Needle, 27g 27 gauge.

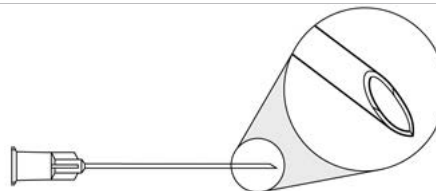

ACCUSURGICAL SINGLE-USE CANNULAS & CYSTOTOMES

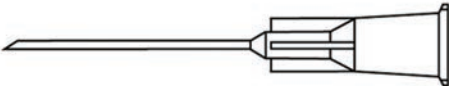
Item #	Description	Image
Non Atkinson Peribulbar Needle		
The AccuSurgical disposable Non Atkinson Peribulbar Needle has a straight shaft and needle tip. Available between 23 to 30 gauge and 16mm to 25mm in overall length. Sold 10 per box.		
AXI4585	Non Atkinson Peribulbar Needle, 23g 23 gauge. Overall length: 16mm.	
AXI4586	Non Atkinson Peribulbar Needle, 25g 25 gauge. Overall length: 16mm.	
AXI4584	Non Atkinson Peribulbar Needle, 25g 25 gauge. Overall length: 22mm.	
AXI4583	Non Atkinson Peribulbar Needle, 25g 25 gauge. Overall length: 25mm.	
AXI4587	Non Atkinson Peribulbar Needle, 27g 27 gauge. Overall length: 16mm.	
AXI4588	Non Atkinson Peribulbar Needle, 30g 30 gauge. Overall length: 16mm.	

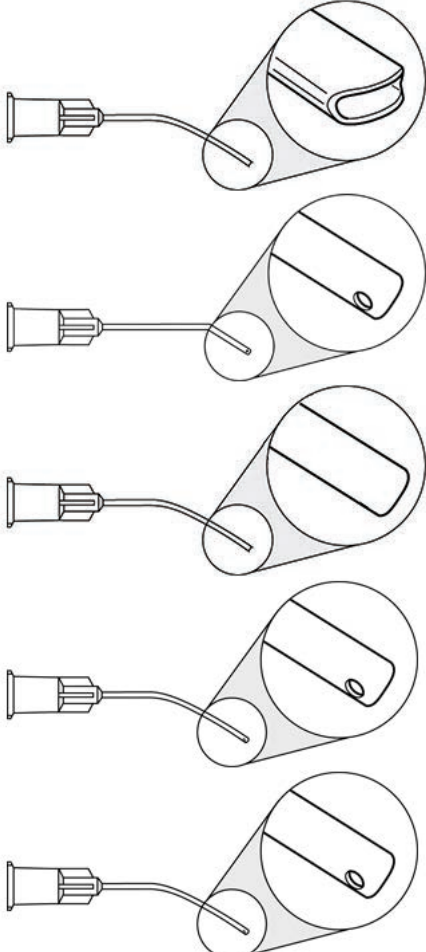
Sub Tenon Anesthesia Cannula		
The AccuSurgical disposable Sub Tenon Anesthesia Cannula has either a curved or angled shaft with various tip types. Available in 19 or 21 gauge and 22mm to 25mm in overall length. Sold 10 per box.		
AXI0914	Sub Tenon Cannula, 19g 19 gauge, curved shaft, flattened tip. Overall length: 25mm.	
AXI4593	Sub Tenon Cannula, 19g 19 gauge, angled shaft, 7mm from bend to tip, blunt tip, tri port. Overall length: 25mm.	
AXI25176	Sub Tenon Cannula, 19g 19 gauge, curved shaft, open tip. Overall length: 22mm.	
AXI4592	Sub Tenon Cannula, 19g 19 gauge, curved shaft, blunt tip, tri port. Overall length: 25mm.	
AXI4590	Sub Tenon Cannula, 21g 21 gauge, curved shaft, blunt tip, tri port. Overall length: 22mm.	

ACCUSURGICAL SINGLE-USE CANNULAS & CYSTOTOMES

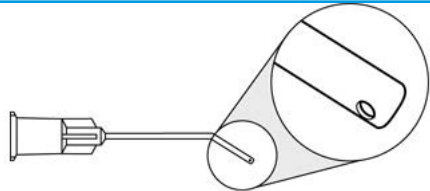
Item #	Description	Image
AXI4591	Sub Tenon Cannula, 21g 21 gauge, angled shaft, 7mm from bend to tip, blunt tip, tri port. Overall length: 22mm.	



Rous Sub Tenon/Parabulbar Needle

19 gauge, angled shaft, 7mm from bend to tip, needle tip, tri port. Disposable, sold 10 per box. Overall length: 25mm.

AXI4594	Rous Sub Tenon/Parabulbar Needle, 19g	
---------	--	--

Anterior Chamber Cannula, Angled

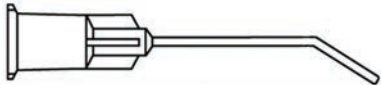
Our single-use Anterior Chamber Cannula, also known as Air Injection, Rycroft, and Viscoelastic cannula, is available from 19 to 30 gauge. Every cannula has a 32-degree angled shaft with blunt and polished tips for smoother radii. Overall length ranges from 22mm to 25mm. Sold 10 per box, unless specified otherwise.

AXI4655	Anterior Chamber Cannula, 19g 19 gauge, 3mm from bend to tip. Overall length: 25mm.	  <table border="1" data-bbox="815 1029 1523 1129"> <thead> <tr> <th>3mm</th> <th>4mm</th> <th>5mm</th> <th>6mm</th> <th>7mm</th> <th>8mm</th> <th>9mm</th> <th>10mm</th> <th>11mm</th> <th>12mm</th> </tr> </thead> <tbody> <tr> <td></td> <td></td> <td></td> <td></td> <td></td> <td></td> <td></td> <td></td> <td></td> <td></td> </tr> </tbody> </table>	3mm	4mm	5mm	6mm	7mm	8mm	9mm	10mm	11mm	12mm										
3mm	4mm		5mm	6mm	7mm	8mm	9mm	10mm	11mm	12mm												
AXI4656	Anterior Chamber Cannula, 19g 19 gauge, 4mm from bend to tip. Overall length: 25mm.																					
AXI4657	Anterior Chamber Cannula, 19g 19 gauge, 5mm from bend to tip. Overall length: 25mm.																					
AXI4658	Anterior Chamber Cannula, 19g 19 gauge, 6mm from bend to tip. Overall length: 25mm.																					
AXI4659	Anterior Chamber Cannula, 19g 19 gauge, 7mm from bend to tip. Overall length: 25mm.																					
AXI4660	Anterior Chamber Cannula, 19g 19 gauge, 8mm from bend to tip. Overall length: 25mm.																					
AXI4661	Anterior Chamber Cannula, 19g 19 gauge, 9mm from bend to tip. Overall length: 25mm.																					
AXI4662	Anterior Chamber Cannula, 19g 19 gauge, 10mm from bend to tip. Overall length: 25mm.																					
AXI4663	Anterior Chamber Cannula, 19g 19 gauge, 11mm from bend to tip. Overall length: 25mm.																					
AXI4664	Anterior Chamber Cannula, 19g 19 gauge, 12mm from bend to tip. Overall length: 25mm.																					
AXI4645	Anterior Chamber Cannula, 20g 20 gauge, 3mm from bend to tip. Overall length: 25mm.																					
AXI4646	Anterior Chamber Cannula, 20g 20 gauge, 4mm from bend to tip. Overall length: 25mm.																					
AXI4647	Anterior Chamber Cannula, 20g 20 gauge, 5mm from bend to tip. Overall length: 25mm.																					
AXI4648	Anterior Chamber Cannula, 20g 20 gauge, 6mm from bend to tip. Overall length: 25mm.																					

ACCUSURGICAL SINGLE-USE CANNULAS & CYSTOTOMES

Item #	Description	Image
AXI21277B	Anterior Chamber Cannula, 20g 20 gauge, 7mm from bend to tip. Overall length: 25mm.	
AXI261	Anterior Chamber Cannula, 20g 20 gauge, 8mm from bend to tip. Overall length: 25mm.	
AXI4651	Anterior Chamber Cannula, 20g 20 gauge, 9mm from bend to tip. Overall length: 25mm.	
AXI4652	Anterior Chamber Cannula, 20g 20 gauge, 10mm from bend to tip. Overall length: 25mm.	
AXI4653	Anterior Chamber Cannula, 20g 20 gauge, 11mm from bend to tip. Overall length: 25mm.	
AXI4654	Anterior Chamber Cannula, 20g 20 gauge, 12mm from bend to tip. Overall length: 25mm.	
AXI4635	Anterior Chamber Cannula, 21g 21 gauge, 3mm from bend to tip. Overall length: 22mm.	
AXI4636	Anterior Chamber Cannula, 21g 21 gauge, 4mm from bend to tip. Overall length: 22mm.	
AXI4637	Anterior Chamber Cannula, 21g 21 gauge, 5mm from bend to tip. Overall length: 22mm.	
AXI4638	Anterior Chamber Cannula, 21g 21 gauge, 6mm from bend to tip. Overall length: 22mm.	
AXI4639	Anterior Chamber Cannula, 21g 21 gauge, 7mm from bend to tip. Overall length: 22mm.	
AXI4640	Anterior Chamber Cannula, 21g 21 gauge, 8mm from bend to tip. Overall length: 22mm.	
AXI4641	Anterior Chamber Cannula, 21g 21 gauge, 9mm from bend to tip. Overall length: 22mm.	
AXI4642	Anterior Chamber Cannula, 21g 21 gauge, 10mm from bend to tip. Overall length: 22mm.	
AXI4643	Anterior Chamber Cannula, 21g 21 gauge, 11mm from bend to tip. Overall length: 22mm.	
AXI4644	Anterior Chamber Cannula, 21g 21 gauge, 12mm from bend to tip. Overall length: 22mm.	
AXI4625	Anterior Chamber Cannula, 23g 23 gauge, 3mm from bend to tip. Overall length: 22mm.	
AXI3254	Anterior Chamber Cannula, 23g 23 gauge, 4mm from bend to tip. Overall length: 22mm.	
AXI4627	Anterior Chamber Cannula, 23g 23 gauge, 5mm from bend to tip. Overall length: 22mm.	
AXI4628	Anterior Chamber Cannula, 23g 23 gauge, 6mm from bend to tip. Overall length: 22mm.	
AXI4629	Anterior Chamber Cannula, 23g 23 gauge, 7mm from bend to tip. Overall length: 22mm.	
AXI4630	Anterior Chamber Cannula, 23g 23 gauge, 8mm from bend to tip. Overall length: 22mm.	

ACCUSURGICAL SINGLE-USE CANNULAS & CYSTOTOMES

Item #	Description	Image
AXI4631	Anterior Chamber Cannula, 23g 23 gauge, 9mm from bend to tip. Overall length: 22mm.	
AXI4632	Anterior Chamber Cannula, 23g 23 gauge, 10mm from bend to tip. Overall length: 22mm.	
AXI4633	Anterior Chamber Cannula, 23g 23 gauge, 11mm from bend to tip. Overall length: 22mm.	
AXI4634	Anterior Chamber Cannula, 23g 23 gauge, 12mm from bend to tip. Overall length: 22mm.	
AXI4615	Anterior Chamber Cannula, 25g 25 gauge, 3mm from bend to tip. Overall length: 22mm.	
AXI21639	Anterior Chamber Cannula, 25g 25 gauge, 4mm from bend to tip. Overall length: 22mm.	
AXI4617	Anterior Chamber Cannula, 25g 25 gauge, 5mm from bend to tip. Overall length: 22mm.	
AXI2080	Anterior Chamber Cannula, 25g 25 gauge, 6mm from bend to tip. Overall length: 22mm.	
AXI4619	Anterior Chamber Cannula, 25g 25 gauge, 7mm from bend to tip. Overall length: 22mm.	
AXI21638	Anterior Chamber Cannula, 25g 25 gauge, 8mm from bend to tip. Overall length: 22mm.	
AXI4621	Anterior Chamber Cannula, 25g 25 gauge, 9mm from bend to tip. Overall length: 22mm.	
AXI21280	Anterior Chamber Cannula, 25g 25 gauge, 10mm from bend to tip. Overall length: 22mm.	
AXI4623	Anterior Chamber Cannula, 25g 25 gauge, 11mm from bend to tip. Overall length: 22mm.	
AXI4624	Anterior Chamber Cannula, 25g 25 gauge, 12mm from bend to tip. Overall length: 22mm.	
AXI4605	Anterior Chamber Cannula, 27g 27 gauge, 3mm from bend to tip. Overall length: 22mm.	
AXI21273A	Anterior Chamber Cannula, 27g 27 gauge, 4mm from bend to tip. Overall length: 22mm.	
AXI21273A-BULK	Anterior Chamber Cannula, 27g 27 gauge, 4mm from bend to tip. Overall length: 22mm. Sold 100 per bag.	
AXI4607	Anterior Chamber Cannula, 27g 27 gauge, 5mm from bend to tip. Overall length: 22mm.	
AXI21276A	Anterior Chamber Cannula, 27g 27 gauge, 6mm from bend to tip. Overall length: 22mm.	
AXI1463	Anterior Chamber Cannula, 27g 27 gauge, 7mm from bend to tip. Overall length: 22mm.	
AXI1956	Anterior Chamber Cannula, 27g 27 gauge, 8mm from bend to tip. Overall length: 22mm.	
AXI4611	Anterior Chamber Cannula, 27g 27 gauge, 9mm from bend to tip. Overall length: 22mm.	

ACCUSURGICAL SINGLE-USE CANNULAS & CYSTOTOMES

Item #	Description	Image
AXI21274	Anterior Chamber Cannula, 27g 27 gauge, 10mm from bend to tip. Overall length: 22mm.	
AXI4613	Anterior Chamber Cannula, 27g 27 gauge, 11mm from bend to tip. Overall length: 22mm.	
AXI4614	Anterior Chamber Cannula, 27g 27 gauge, 12mm from bend to tip. Overall length: 22mm.	
AXI4595	Anterior Chamber Cannula, 30g 30 gauge, 3mm from bend to tip. Overall length: 22mm.	
AXI21273	Anterior Chamber Cannula, 30g 30 gauge, 4mm from bend to tip. Overall length: 22mm.	
AXI21273-BULK	Anterior Chamber Cannula, 30g 30 gauge, 4mm from bend to tip. Overall length: 22mm. Sold 100 per bag.	
AXI4597	Anterior Chamber Cannula, 30g 30 gauge, 5mm from bend to tip. Overall length: 22mm.	
AXI21276	Anterior Chamber Cannula, 30g 30 gauge, 6mm from bend to tip. Overall length: 22mm.	
AXI1630	Anterior Chamber Cannula, 30g 30 gauge, 7mm from bend to tip. Overall length: 22mm.	
AXI21278	Anterior Chamber Cannula, 30g 30 gauge, 8mm from bend to tip. Overall length: 22mm.	
AXI4601	Anterior Chamber Cannula, 30g 30 gauge, 9mm from bend to tip. Overall length: 22mm.	
AXI4602	Anterior Chamber Cannula, 30g 30 gauge, 10mm from bend to tip. Overall length: 22mm.	
AXI4603	Anterior Chamber Cannula, 30g 30 gauge, 11mm from bend to tip. Overall length: 22mm.	
AXI4604	Anterior Chamber Cannula, 30g 30 gauge, 12mm from bend to tip. Overall length: 22mm.	

ACCUSURGICAL SINGLE-USE CANNULAS & CYSTOTOMES

Item #	Description	Image
--------	-------------	-------

Anterior Chamber Cannula, Straight

Our single-use Anterior Chamber Cannula, also known as Air Injection, Rycroft, and Viscoelastic cannula, is available from 19 to 30 gauge. Every cannula has a straight shaft with a blunt tip. Overall length ranges from 22mm to 32mm. Sold 10 per box.

AXI4678	Anterior Chamber Cannula, 19g	
---------	--------------------------------------	--

19 gauge. Overall length: 25mm.

AXI4676	Anterior Chamber Cannula, 20g
---------	--------------------------------------

20 gauge. Overall length: 25mm.

AXI4674	Anterior Chamber Cannula, 21g
---------	--------------------------------------

21 gauge. Overall length: 22mm.

AXI4671	Anterior Chamber Cannula, 23g
---------	--------------------------------------

23 gauge. Overall length: 22mm.

AXI4672	Anterior Chamber Cannula, 23g
---------	--------------------------------------

23 gauge. Overall length: 32mm.

AXI4669	Anterior Chamber Cannula, 25g
---------	--------------------------------------

25 gauge. Overall length: 22mm.

AXI4667	Anterior Chamber Cannula, 27g
---------	--------------------------------------

27 gauge. Overall length: 22mm.

AXI4665	Anterior Chamber Cannula, 30g
---------	--------------------------------------

30 gauge. Overall length: 22mm.

Anterior Chamber Cannula, Curved

Our single-use Anterior Chamber Cannula, also known as Air Injection, Rycroft, and Viscoelastic cannula, is available from 19 to 30 gauge. Every cannula has a curved shaft with a blunt tip. Overall length ranges from 22mm to 25mm. Sold 10 per box.

AXI4679	Anterior Chamber Cannula, 19g	
---------	--------------------------------------	--

19 gauge. Overall length: 25mm.

AXI4677	Anterior Chamber Cannula, 20g
---------	--------------------------------------

20 gauge. Overall length: 25mm.

AXI4675	Anterior Chamber Cannula, 21g
---------	--------------------------------------

21 gauge. Overall length: 22mm.

AXI4673	Anterior Chamber Cannula, 23g
---------	--------------------------------------

23 gauge. Overall length: 22mm.

AXI4670	Anterior Chamber Cannula, 25g
---------	--------------------------------------

25 gauge. Overall length: 22mm.

AXI4668	Anterior Chamber Cannula, 27g
---------	--------------------------------------

27 gauge. Overall length: 22mm.

AXI4666	Anterior Chamber Cannula 30g
---------	-------------------------------------

30 gauge. Overall length: 22mm.

ACCUSURGICAL SINGLE-USE CANNULAS & CYSTOTOMES

Item # **Description** **Image**

Air Injection Cannula

26 gauge, angled shaft, 10mm from bend to tip, blunt tip. Disposable, sold 10 per box.

AXI21277 **Air Injection Cannula, 26g**

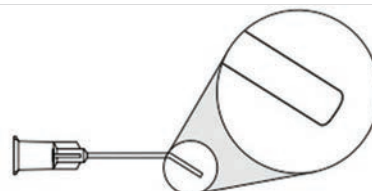

Viscoelastic Cannula

Disposable Viscoelastic Cannulas are 27 gauge with the option of an angled or formed shaft. They are 11mm from bend to tip and have blunt tips. Overall length: 22mm. Sold 10 per box.

AXI21279A **Angled Viscoelastic Cannula**
Angled shaft.

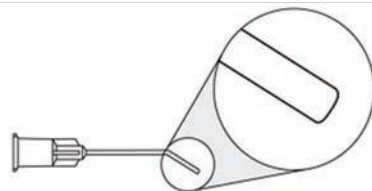

AXI4680 **Formed Viscoelastic Cannula**
Formed shaft.

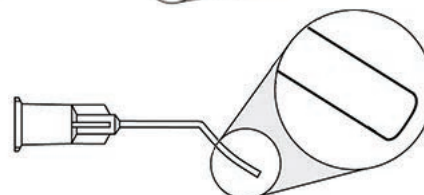

Thin Wall Anterior Chamber Cannula, Angled

A thin wall cannula allows the advantage of a larger bore through a smaller cannula. The inside diameter is approximately 2 gauge sizes larger, therefore, a 25 gauge thin wall lumen is approximately the same as the inside lumen on a 23 gauge. Thin Wall Anterior Chamber Cannulas are disposable and have angled shafts and blunt tips. Overall length: 22mm. Sold 10 per box.

AXI4691 **Thin Wall Cannula, 23g**
23 gauge thin wall, 3mm from bend to tip.

AXI4692 **Thin Wall Cannula, 23g**
23 gauge thin wall, 4mm from bend to tip.

AXI4693 **Thin Wall Cannula, 23g**
23 gauge thin wall, 5mm from bend to tip.

AXI4694 **Thin Wall Cannula, 23g**
23 gauge thin wall, 6mm from bend to tip.

AXI4695 **Thin Wall Cannula, 23g**
23 gauge thin wall, 7mm from bend to tip.

AXI4696 **Thin Wall Cannula, 23g**
23 gauge thin wall, 8mm from bend to tip.

AXI4697 **Thin Wall Cannula, 23g**
23 gauge thin wall, 9mm from bend to tip.

AXI4698 **Thin Wall Cannula, 23g**
23 gauge thin wall, 10mm from bend to tip.

AXI4699 **Thin Wall Cannula, 23g**
23 gauge thin wall, 11mm from bend to tip.

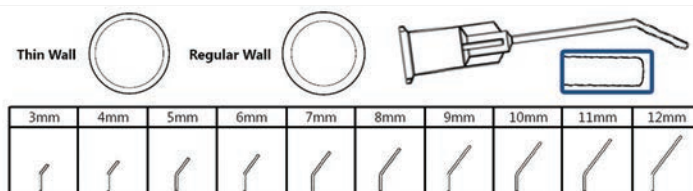

ACCUSURGICAL SINGLE-USE CANNULAS & CYSTOTOMES

Item #	Description	Image
AXI4700	Thin Wall Cannula, 23g 23 gauge thin wall, 12mm from bend to tip.	
AXI4681	Thin Wall Cannula, 25g 25 gauge thin wall, 3mm from bend to tip.	
AXI4682	Thin Wall Cannula, 25g 25 gauge thin wall, 4mm from bend to tip.	
AXI4683	Thin Wall Cannula, 25g 25 gauge thin wall, 5mm from bend to tip.	
AXI4684	Thin Wall Cannula, 25g 25 gauge thin wall, 6mm from bend to tip.	
AXI4685	Thin Wall Cannula, 25g 25 gauge thin wall, 7mm from bend to tip.	
AXI4686	Thin Wall Cannula, 25g 25 gauge thin wall, 8mm from bend to tip.	
AXI4687	Thin Wall Cannula, 25g 25 gauge thin wall, 9mm from bend to tip.	
AXI4688	Thin Wall Cannula, 25g 25 gauge thin wall, 10mm from bend to tip.	
AXI4689	Thin Wall Cannula, 25g 25 gauge thin wall, 11mm from bend to tip.	
AXI4690	Thin Wall Cannula, 25g 25 gauge thin wall, 12mm from bend to tip.	

Thin Wall Anterior Chamber Cannula, Curved

A thin wall cannula allows the advantage of a larger bore through a smaller cannula. The inside diameter is approximately 2 gauge sizes larger, therefore, a 25 gauge thin wall lumen is approximately the same as the inside lumen on a 23 gauge. Thin Wall Anterior Chamber Cannulas are disposable and have curved shafts and blunt tips. Overall length: 22mm. Sold 10 per box.

AXI4704	Anterior Chamber Cannula, 23g 23 gauge thin wall.
AXI4702	Anterior Chamber Cannula, 25g 25 gauge thin wall.

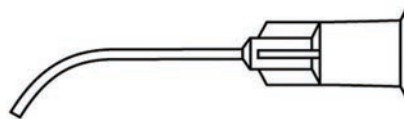
**Thin Wall Anterior Chamber Cannula, Straight**

A thin wall cannula allows the advantage of a larger bore through a smaller cannula. The inside diameter is approximately 2 gauge sizes larger, therefore, a 25 gauge thin wall lumen is approximately the same as the inside lumen on a 23 gauge. Thin Wall Anterior Chamber Cannulas are disposable and have straight shafts and blunt tips. Overall length: 22mm. Sold 10 per box.

AXI4703	Anterior Chamber Cannula, 23g 23 gauge thin wall.
AXI4701	Anterior Chamber Cannula, 25g 25 gauge thin wall.

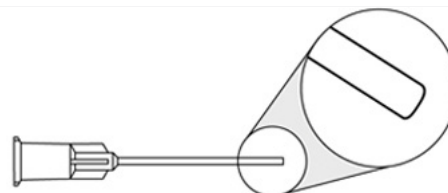

ACCUSURGICAL SINGLE-USE CANNULAS & CYSTOTOMES

Item #	Description	Image
--------	-------------	-------

Double I/A Cannula

Double Irrigating and Aspirating Cannulas are part of our disposable line. Each cannula has a straight shaft and are available in various gauges and tip types. Sold 10 per box.

AXI4705	Double I/A Cannula Sideport 21 gauge, one rounded closed 0.3mm sideport tip, one open tip.
AXI4707	Double I/A Cannula Open End 21 gauge, both tips are open ended.
AXI4708	Double I/A Cannula Open End 21 gauge, 19 gauge, both tips are open ended.

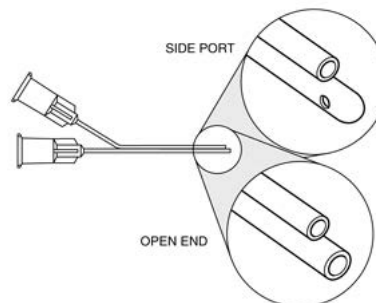

J-Shaped Double I/A Cannula

23 gauge and 25 gauge, straight shaft, open ended top tip, J-shaped bottom tip with 0.2mm sideport. Disposable, sold 10 per box.

AXI4706	J-Shaped Double I/A Cannula
---------	------------------------------------

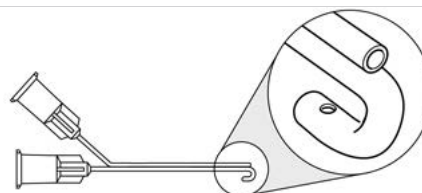

Double Barrel I/A Cannula [Simcoe]

Disposable Double Barrel Irrigating and Aspirating Cannulas are 23 gauge with curved shafts. They have rounded closed tips with 0.3mm sideport on the top or bottom and an open-ended slanted tip. Each cannula comes with 6" silicone tubing and measures 16mm in overall length. Sold 10 per box.

AXI4710	Double Barrel I/A Cannula, Reverse Sideport on bottom, open-ended slanted tip on top.
AXI61571	Double Barrel I/A Cannula, Standard Sideport on top, open-ended slanted tip on bottom.

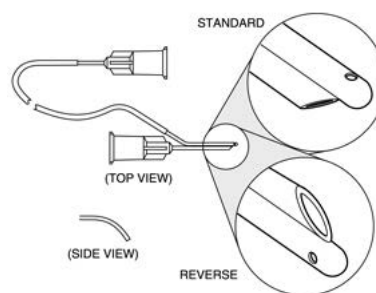

Cortex Extractor [Charleux]

23 gauge, curved shaft, open pointed tip. Overall length: 13mm. Disposable, sold 10 per box.

AXI4713	Cortex Extractor, 23g
---------	------------------------------

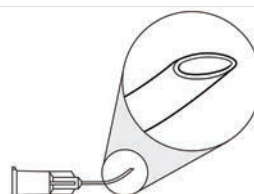

ACCUSURGICAL SINGLE-USE CANNULAS & CYSTOTOMES

Item #	Description	Image
--------	-------------	-------

Cortex Extractor [Simcoe]

Disposable Simcoe Cortex Extractor Cannulas are 23 gauge with curved shafts and rounded closed tips with 0.3mm sideport. Various lengths are available. Sold 10 per box.

AXI4711 **Cortex Extractor, 23g**
Overall length: 13mm.

AXI55075 **Cortex Extractor, 23g**
Overall length: 22mm.

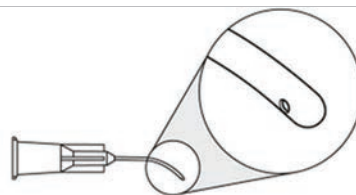

Button Coaxial I/A System

Disposable Button Coaxial Irrigating and Aspirating Systems have a 17 gauge thin wall outer cannula and a 21 gauge inner cannula. Straight shafts with closed, rounded tip and 0.3mm sideport. Overall length: 30mm. Sold 10 per box.

AXI4714 **Button Coaxial I/A System, Angled**
30-degree angled tip.

AXI4715 **Button Coaxial I/A System, Straight**
Straight tip.

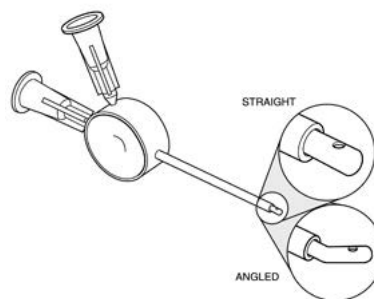

J-Shaped Cannula

Disposable J-shaped tip cannulas with both straight and angled shafts. Available in sizes from 21 gauge to 30 gauge and various sized tips. Overall length: 22mm. Sold 10 per box, unless specified otherwise.

AXI4725 **J-Shaped Cannula, 21g**
21 gauge, straight shaft, 2mm high x 2mm wide tip.

AXI4723 **J-Shaped Cannula, 23g**
23 gauge, straight shaft, 2mm high x 2mm wide tip.

AXI4724 **J-Shaped Cannula, 23g**
23 gauge, 45 degree angled shaft, 10mm from bend to tip, 2mm high x 2mm wide tip.

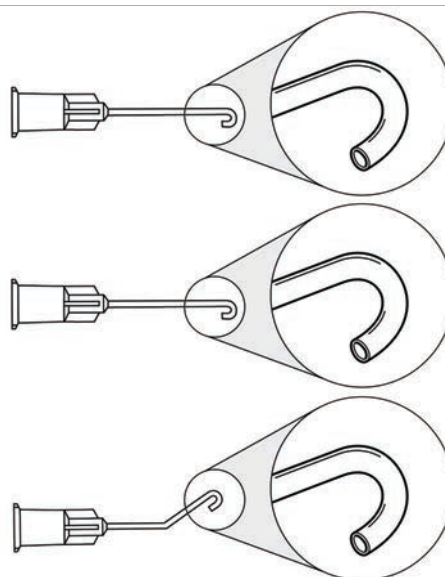

ACCUSURGICAL SINGLE-USE CANNULAS & CYSTOTOMES

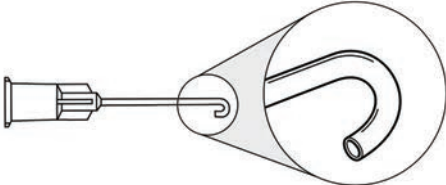
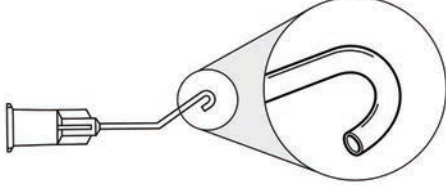
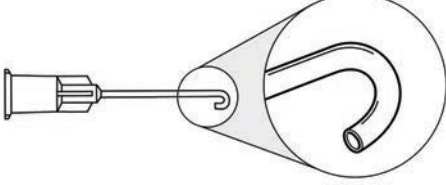
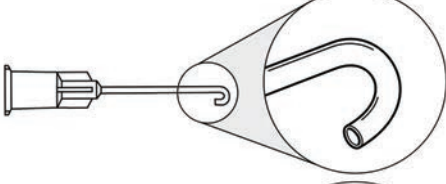
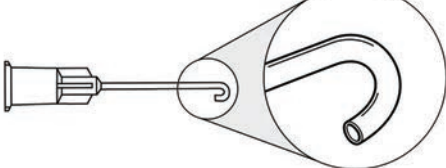
Item #	Description	Image
AXI0761	J-Shaped Cannula, 25g 25 gauge, straight shaft, 1.5mm high x 1.5mm wide tip.	
AXI4719	J-Shaped Cannula, 25g 25 gauge, 45 degree angled shaft, 10mm from bend to tip, 2mm high x 2mm wide tip.	
AXI51297	J-Shaped Cannula, 27g 27 gauge, straight shaft, 1.5mm high x 1.5mm wide tip.	
AXI51297-BULK	J-Shaped Cannula, 27g 27 gauge, straight shaft, 1.5mm high x 1.5mm wide tip. Sold 100 per bag.	
AXI51287	J-Shaped Cannula, 30g 30 gauge, straight shaft, 1.5mm high x 1.5mm wide tip.	

J-Shaped Cannula [Binkhorst]

The J-Shaped Binkhorst Cannula is available for left or right hand usage. Both choices are 25 gauge with 18 degree angled shaft, 12mm from bend to tip. A J-shaped tip that measures 1.5mm high x 1.75mm wide. Overall length: 22mm. Sold 10 per box.

AXI4720	J-Shaped Cannula, 25g, Left Angled left shaft.
AXI4721	J-shaped Cannula, 25g, Right Angled right shaft.

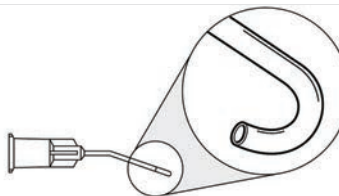

Micro J-Shaped Cannula [Hessburg]

25 gauge, straight shaft, J-shaped tip, 0.85mm long x 1.7mm wide. Overall length: 22mm. Disposable, sold 10 per box.

AXI4722	Micro J-Shaped Cannula
---------	-------------------------------

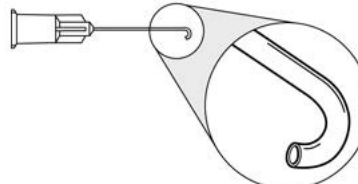

ACCUSURGICAL SINGLE-USE CANNULAS & CYSTOTOMES

Item #	Description	Image
Irrigating Cystotome		
Disposable Irrigating Cystotomes and Capsulorhexis Cystotomes with various shaft and tip styles. Each cystotome has a bent, pointed tip and is available in 23 to 30 gauge in size. Ranges in gauge and shaft styles. Overall length ranges from 16mm to 22mm. Sold 10 per box, unless specified otherwise.		
AXI31599	Irrigating Cystotome, 23g 23 gauge, formed shaft. Overall length: 16mm.	
AXI4731	Irrigating Cystotome, 23g 23 gauge, straight shaft. Overall length: 16mm.	
AXI4732	Irrigating Cystotome, 23g 23 gauge, straight shaft. Overall length: 19mm.	
AXI4739	Irrigating Cystotome, 23g 23 gauge, formed shaft. Overall length: 19mm.	
AXI4752	Capsulorhexis Cystotome, 23g 23 gauge, formed shaft with pointed tips that are twisted 90 degrees. Overall length: 16mm.	
AXI4753	Capsulorhexis Cystotome, 23g 23 gauge, straight shaft with pointed tips that are twisted 90 degrees. Overall length: 16mm.	
AXII348	Irrigating Cystotome, 25g 25 gauge, formed shaft. Overall length: 16mm.	
AXII891	Irrigating Cystotome, 25g 25 gauge, formed shaft, reverse formed, tip angled 90 degrees toward bevel. Overall length: 16mm.	

ACCUSURGICAL SINGLE-USE CANNULAS & CYSTOTOMES

Item #	Description	Image
AXI31610A	<p>Irrigating Cystotome, 25g 25 gauge, straight shaft. Overall length: 16mm.</p>	
AXI31610	<p>Irrigating Cystotome, 25g 25 gauge, formed shaft. Overall length: 16mm.</p>	
AXI31610-BULK	<p>Irrigating Cystotome, 25g 25 gauge, formed shaft. Overall length: 16mm. Sold 100 per bog.</p>	
AXI35004	<p>Irrigating Cystotome, 25g 25 gauge, formed shaft, small radius tip. Overall length: 16mm.</p>	
AXI35049	<p>Irrigating Cystotome, 25g 25 gauge, angled shaft. Overall length: 16mm.</p>	
AXI4743	<p>Irrigating Cystotome [Joyce], 25g 25 gauge, curved shaft. Overall length: 16mm.</p>	
AXI4736	<p>Irrigating Cystotome, 25g 25 gauge, formed shaft. Overall length: 16mm.</p>	
AXI4737	<p>Irrigating Cystotome, 25g 25 gauge, formed shaft. Overall length: 22mm.</p>	

ACCUSURGICAL SINGLE-USE CANNULAS & CYSTOTOMES

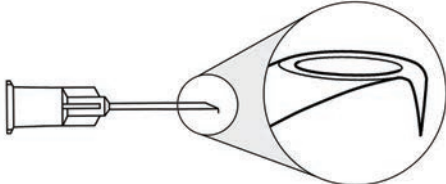
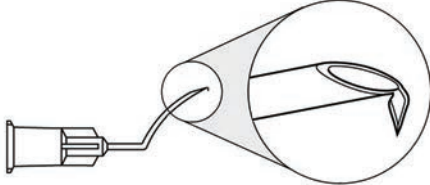
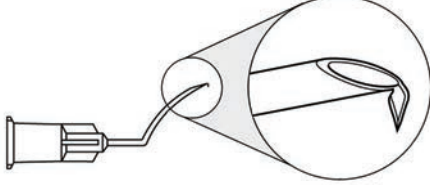
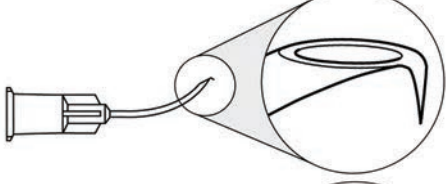
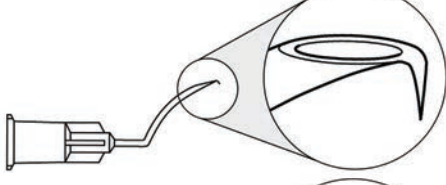
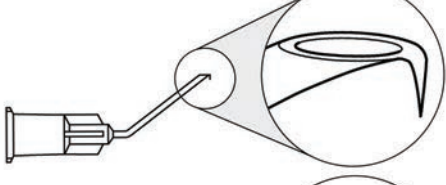
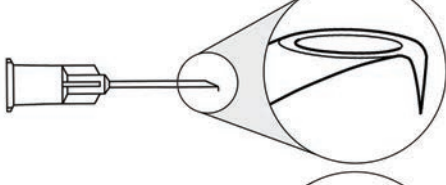
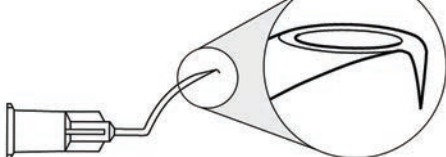
Item #	Description	Image
AXI4730	Irrigating Cystotome, 25g 25 gauge, straight shaft. Overall length: 22mm.	 A technical drawing of a straight shaft cystotome. It shows a cylindrical handle with a textured grip, a long straight shaft, and a circular cross-section of the tip. The tip features a central lumen and a curved, hook-like blade.
AXI35113	Capsulorhexis Cystotome, 25g 25 gauge, formed shaft with pointed tips that are twisted 90 degrees. Overall length: 16mm.	 A technical drawing of a cystotome with a curved shaft. The shaft is formed and has a 90-degree twist at the tip. The tip is circular with a central lumen and a curved blade.
AXI4751	Capsulorhexis Cystotome, 25g 25 gauge, straight shaft with pointed tips that are twisted 90 degrees. Overall length: 16mm.	 A technical drawing of a cystotome with a curved shaft. The shaft is formed and has a 90-degree twist at the tip. The tip is circular with a central lumen and a curved blade.
AXI4742	Irrigating Cystotome [Joyce], 27g 27 gauge, curved shaft. Overall length: 16mm.	 A technical drawing of a cystotome with a curved shaft. The shaft is formed and has a 90-degree twist at the tip. The tip is circular with a central lumen and a curved blade.
AXI31618	Irrigating Cystotome, 27g 27 gauge, formed shaft. Overall length: 16mm.	 A technical drawing of a cystotome with a curved shaft. The shaft is formed and has a 90-degree twist at the tip. The tip is circular with a central lumen and a curved blade.
AXI35093	Irrigating Cystotome, 27g 27 gauge, angled shaft. Overall length: 16mm.	 A technical drawing of a cystotome with an angled shaft. The shaft is formed and has a 90-degree twist at the tip. The tip is circular with a central lumen and a curved blade.
AXI4727	Irrigating Cystotome, 27g 27 gauge, straight shaft. Overall length: 16mm.	 A technical drawing of a straight shaft cystotome. It shows a cylindrical handle with a textured grip, a long straight shaft, and a circular cross-section of the tip. The tip features a central lumen and a curved, hook-like blade.
AXI4745	Irrigating Cystotome, 27g 27 gauge, formed shaft, small radius tip. Overall length: 16mm.	 A technical drawing of a cystotome with a curved shaft. The shaft is formed and has a 90-degree twist at the tip. The tip is circular with a central lumen and a curved blade.

ACCUSURGICAL SINGLE-USE CANNULAS & CYSTOTOMES

Item #	Description	Image
AXI4728	<p>Irrigating Cystotome, 27g 27 gauge, straight shaft. Overall length: 19mm.</p>	
AXI4735	<p>Irrigating Cystotome, 27g 27 gauge, formed shaft. Overall length: 19mm.</p>	
AXI35042	<p>Capsulorhexis Cystotome, 27g 27 gauge, formed shaft with pointed tips that are twisted 90 degrees. Overall length: 16mm.</p>	
AXI4749	<p>Capsulorhexis Cystotome, 27g 27 gauge, straight shaft with pointed tips that are twisted 90 degrees. Overall length: 16mm.</p>	
AXI4726	<p>Irrigating Cystotome, 30g 30 gauge, straight shaft. Overall length: 16mm.</p>	

Irrigating Double Sharp Cystotome [Kelman]

22 gauge, straight shaft, bent, pointed tip. Overall length: 25mm. Disposable, sold 10 per box.

AXI4755	<p>Irrigating Double Sharp Cystotome, 22g</p>	
---------	--	--

ACCUSURGICAL SINGLE-USE CANNULAS & CYSTOTOMES

Item #	Description	Image
--------	-------------	-------

Irrigating Sharp Cystotome [Kelman]

22 gauge, straight shaft, bent, pointed tip. Overall length: 25mm. Disposable, sold 10 per box.

AXI4754	Irrigating Sharp Cystotome, 22g
---------	--

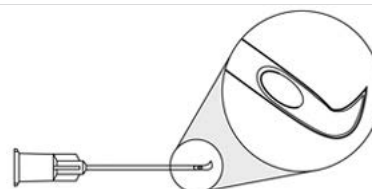

Capsule Polisher

Single-use Capsule Polisher cannula available in 21 gauge or 23 gauge sizes with a 37 degree angled shaft. Angled shaft is 7mm from bend to tip and has various types of 3mm sandblasted tips. Overall length: 22mm. Sold 10 per box.

AXI4756	<p>Capsule Polisher, 21g 21 gauge, 3mm sandblasted closed distal tip with 0.3mm sideport.</p>
---------	---

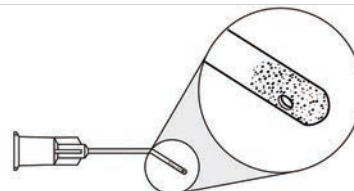

AXI4758	<p>Capsule Polisher, 21g 21 gauge, 3mm sandblasted distal end tip, open ended.</p>
---------	--

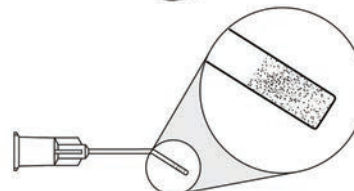

AXI4757	<p>Capsule Polisher, 23g 23 gauge, 3mm sandblasted closed distal tip with 0.3mm sideport.</p>
---------	---

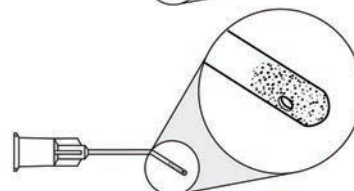

AXI4759	<p>Capsule Polisher, 23g 23 gauge, 3mm sandblasted distal end tip, open ended.</p>
---------	--

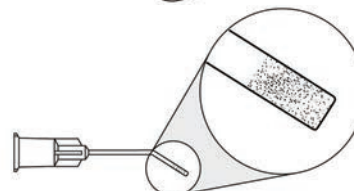

Posterior Capsule Polisher

23 gauge, 45-degree angled shaft, 12mm from bend to tip, 2mm sandblasted distal end, angled 90 degrees. Overall length: 22mm. Disposable, sold 10 per box.

AXI4760	Posterior Capsule Polisher, 23g
---------	--

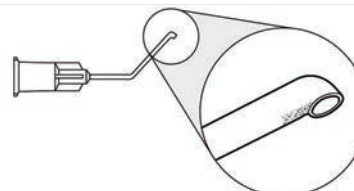

ACCUSURGICAL SINGLE-USE CANNULAS & CYSTOTOMES

Item #	Description	Image
--------	-------------	-------

Silicone Tip Capsule Polisher

Disposable Silicone Tip Capsule Polisher cannula with 32-degree angled shafts. Cannulas come with various lengths of squeegee, silicone tubing. Overall length: 22mm. Sold 10 per box.

AXI75041	Capsule Polisher, 23g 23 gauge, 7mm from bend to tip, 10mm silicone tubing.
AXI4763	Capsule Polisher, 23g 23 gauge, 9mm from bend to tip, 12mm silicone tubing.
AXI75005	Capsule Polisher, 27g 27 gauge, 7mm from bend to tip, 10mm silicone tubing.

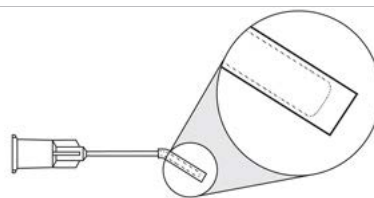

Irrigating Vectis

24 gauge Irrigating Vectis cannula is part of the AccuSurgical Single Use line. Each cannula has a straight shaft with a curved looped tip and one to three ports. Tips are available in 3mm to 5mm widths. Sold 10 per box.

AXI4765	Irrigating Vectis, 3mm Curved 3mm loop tip, one 0.3mm port.
AXI4766	Irrigating Vectis, 4mm Curved 4mm loop tip, two 0.3mm ports.
AXI4767	Irrigating Vectis, 5mm Curved 5mm loop tip, three 0.3mm ports.
AXI4764	Irrigating Vectis, 5mm Curved 5mm loop tip, one 0.3mm port.

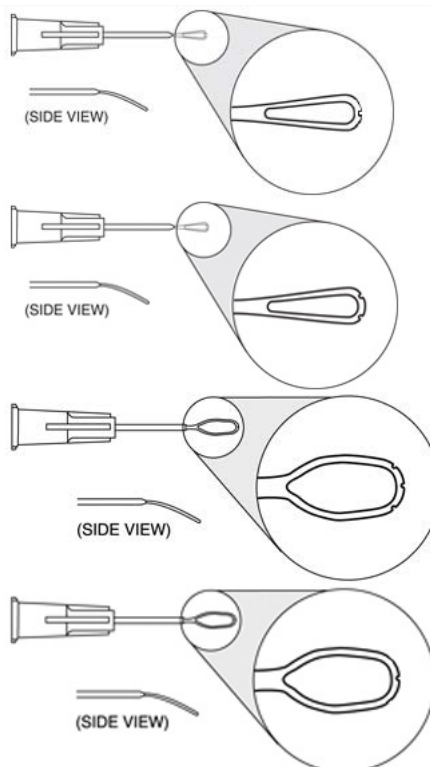

Bishop-Harmon Washout Cannula

Disposable 19 gauge Bishop-Harmon Washout Cannulas with 37-degree angled shafts and smooth oval shaped tips. Overall length: 25mm. Sold 10 per box unless specified otherwise.

AXI65041	Washout Cannula, 19g 19 gauge, 37-degree angled shaft, 5mm from bend to tip.
AXI65040	Washout Cannula, 19g 19 gauge, 37-degree angled shaft, 8mm from bend to tip.
AXI65040-BULK	Washout Cannula, 19g 19 gauge, 37-degree angled shaft, 8mm from bend to tip. Sold 100 per bag.

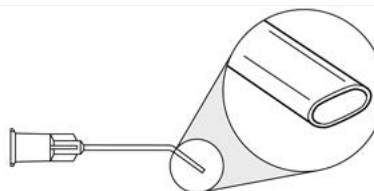

ACCUSURGICAL SINGLE-USE CANNULAS & CYSTOTOMES

Item #	Description	Image
--------	-------------	-------

Nucleus Hydrodissection Cannula

Disposable Nucleus Hydrodissection Cannula with 32-degree angled shaft, 8mm from bend to tip. Cannulas are available in 23 gauge to 30 gauge sizes with flattened, smooth, oval-shaped tip. Overall length: 22mm. Sold 10 per box, unless specified otherwise.

AXI4772	Nucleus Hydrodissection Cannula, 23g 23 gauge.
AXI25037	Nucleus Hydrodissection Cannula, 25g 25 gauge.
AXI25037-BULK	Nucleus Hydrodissection Cannula, 25g 25 gauge. Sold 100 per bag.
AXI25158	Nucleus Hydrodissection Cannula, 27g 27 gauge.
AXI3014	Nucleus Hydrodissection Cannula, 30g 30 gauge.

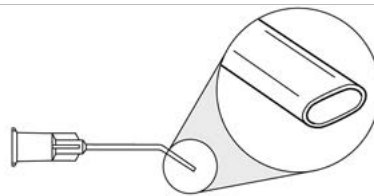

Hydrodissection Cannula [Chang]

27 gauge, straight shaft, flattened tip. Overall length: 22mm. Disposable, sold 10 per box.

AXI4784	Hydrodissection Cannula
---------	--------------------------------

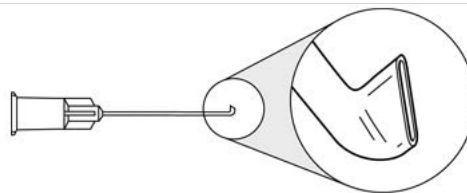

Hydrodissection Cannula [Kellan]

Kellan Hydrodissection Cannulas are part of the AccuSurgical Single Use product line. These cannulas are available in 25 gauge or 27 gauge with curved shafts and blunt, oval-shaped tips. Overall length: 22mm. Sold 10 per box.

AXI4778	Hydrodissection Cannula, 25g 25 gauge.
AXI21273D	Hydrodissection Cannula, 27g 27 gauge.

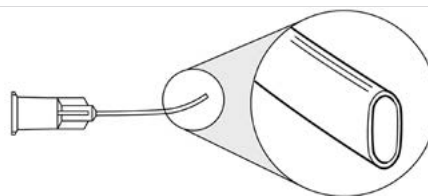

ACCUSURGICAL SINGLE-USE CANNULAS & CYSTOTOMES

Item #	Description	Image
--------	-------------	-------

J-Shaped Hydrodissection Cannula

Disposable J-Shaped Hydrodissection Cannulas range in size from 25 gauge to 30 gauge. Each cannula has a straight shaft with a smooth oval and J-shaped tip that is available in different widths. Overall length: 22mm. Sold 10 per box.

AXI4775	J-Shaped Hydrodissection Cannula, 25g	
---------	--	--

25 gauge, 1.5mm high x 2mm wide tip.

AXI25029	J-Shaped Hydrodissection Cannula, 27g
----------	--

27 gauge, 1.5mm high x 1.75mm wide tip.

AXI4773	J-Shaped Hydrodissection Cannula, 30g
---------	--

30 gauge, 1.5mm high x 1.5mm wide tip.

Hydrodelineation Needle [Kellan]

Disposable Kellan Hydrodelineation Needles are available in 25 gauge or 27 gauge sizes. Each one has a curved shaft with a shortened bevel, needle tip. Overall length: 22mm. Sold 10 per box.

AXI4776	Hydrodelineation Needle, 25g	
---------	-------------------------------------	--

25 gauge.

AXI4777	Hydrodelineation Needle, 27g
---------	-------------------------------------

27 gauge.

Nucleus Hydrolysis Needle [P. Koch]

25 gauge, curved shaft, flattened, oval-shaped tip. Overall length: 22mm. Disposable, sold 10 per box.

AXI4780	Nucleus Hydrolysis Needle, 25g	
---------	---------------------------------------	--

Nucleus Hydrodissector/Rotator [Sinskey]

25 gauge, 32-degree angled shaft, 8mm from bend to tip, forked blunt tip. Overall length: 22mm. Disposable, sold 10 per box.

AXI4781	Nucleus Hydrodissector/Rotator	
---------	---------------------------------------	--

Cotrical Cleaving Hydrodissector

27 gauge, angled shaft, 11mm from bend to tip, horizontally flattened tip, flattened 4mm from tip. Overall length: 22mm. Disposable, sold 10 per box.

AXI25157	Cotrical Cleaving Hydrodissector, 27g	
----------	--	--

ACCUSURGICAL SINGLE-USE CANNULAS & CYSTOTOMES

Item #	Description	Image
--------	-------------	-------

Nucleus Hydrodissector

27 gauge, curved shaft, tip flattened horizontally 4mm from end. Overall length: 22mm. Disposable, sold 10 per box.

AXI25155 **Nucleus Hydrodissector, 27g**

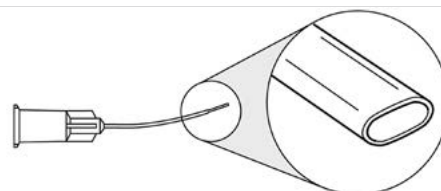

Lacrimal Cannula

Disposable Lacrimal Cannulas are available with either straight or curved shafts. Sizes range from 19 gauge to 26 gauge. Sold 10 per box.

AXI4786 **Lacrimal Cannula Straight, 19g**
 19 gauge tapered to 23 gauge, straight shaft, tapered 12mm from tip. Overall length: 38mm.

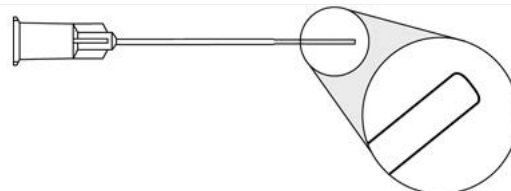

AXI4785 **Lacrimal Cannula Curved, 25g**
 25 gauge, slightly curved shaft, tumble polished edge. Overall length: 28mm.

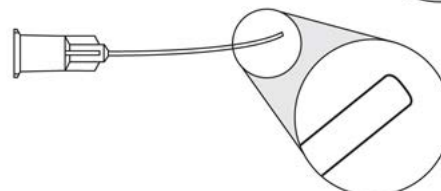

AXI0649 **Lacrimal Cannula Curved, 26g**
 26 gauge, curved shaft, open tip. Overall length: 28mm.

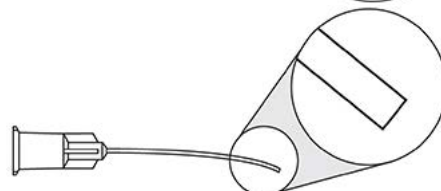

Irrigating Dialer

30 gauge, 45-degree angled shaft, 10mm from bend to tip, 1mm distal end angled 65 degrees. Overall length: 22mm. Disposable, sold 10 per box.

AXI4802 **Irrigating Dialer**

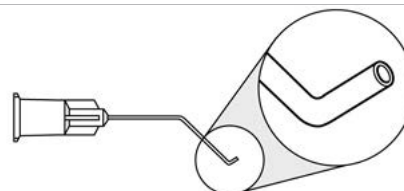

Alpha-Chymotrypsin Cannula

25 gauge, curved shaft, 1mm smooth, bulbous tip. Overall length: 28mm. Disposable, sold 10 per box.

AXI4808 **Alpha-Chymotrypsin Cannula**

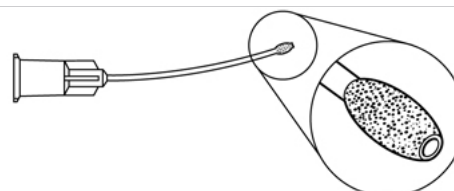

ACCUSURGICAL SINGLE-USE CANNULAS & CYSTOTOMES

Item #	Description	Image
--------	-------------	-------

Olive Tip Capsule Polisher

Disposable Olive Tip Cannulas range from 23 gauge to 25 gauge in size and are available with angled or curved shafts. Each cannula has a 1mm sandblasted or smooth bulbous tip. Sold 10 per box.

AXI4810 **Olive Tip Capsule Polisher, 23g**
23 gauge, curved shaft. Smooth tip. Overall length: 22mm.

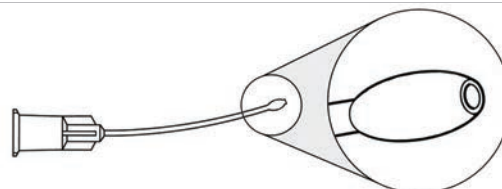

AXI4812 **Olive Tip Capsule Polisher, 23g**
23 gauge, angled shaft, 10mm from bend to tip. Sandblasted tip. Overall length: 22mm.

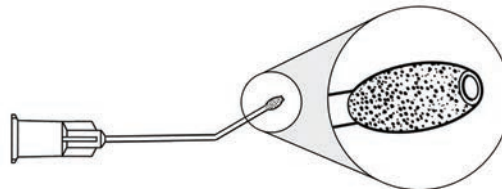

AXI4811 **Olive Tip Capsule Polisher, 23g**
23 gauge, curved shaft. Sandblasted tip. Overall length: 22mm.

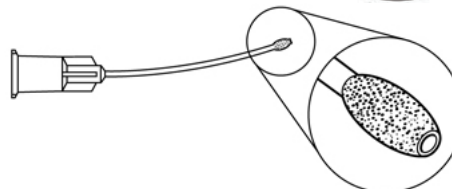

AXI4809 **Olive Tip Capsule Polisher, 25g**
25 gauge, curved shaft. Sandblasted tip. Overall length: 28mm.

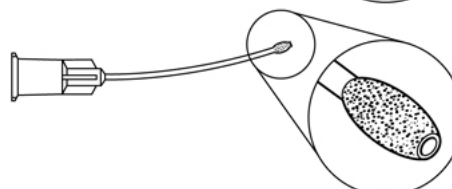

Chamber Maintainer

Disposable Chamber Maintainer cannulas range from 20 gauge to 27 gauge in size. Each cannula has a straight shaft with a sharp, closed end tip with a 0.2mm or 0.3mm sideport. Comes with 6" silicone tubing and has an overall length of 22mm. Sold 10 per box.

AXI4820 **Chamber Maintainer, 20g**
20 gauge, 0.3mm sideport, 6" silicone tubing: ID - 0.75mm (0.030"), OD - 1.65mm (0.065").

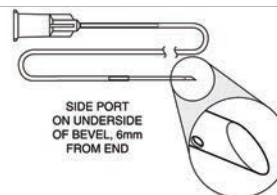

AXI4819 **Chamber Maintainer, 23g**
23 gauge, 0.3mm sideport, 6" silicone tubing: ID - 0.5mm (0.020"), OD - 0.95mm (0.037").

AXI4818 **Chamber Maintainer, 25g**
25 gauge, 0.2mm sideport, 6" silicone tubing: ID - 0.3mm (0.012"), OD - 0.6mm (0.025").

AXI4817 **Chamber Maintainer, 27g**
27 gauge, 0.2mm sideport, 6" silicone tubing: ID - 0.3mm (0.012"), OD - 0.6mm (0.025").

ACCUSURGICAL SINGLE-USE CANNULAS & CYSTOTOMES

Item #	Description	Image
--------	-------------	-------

Chamber Maintainer with Serrated Tip

Disposable Chamber Maintainer cannulas range from 23 gauge to 25 gauge in size. Each cannula has a straight shaft with a 4mm serrated, pointed tip with 6" silicone tubing. Overall length: 22mm. Sold 10 per box.

AXI4822	<p>Chamber Maintainer, 23g</p> <p>23 gauge, 6" silicone tubing: ID - 0.5mm (0.020"), OD - 0.95mm (0.037").</p>
---------	---

AXI4821	<p>Chamber Maintainer, 25g</p> <p>25 gauge, 6" silicone tubing: ID - 0.3mm (0.012"), OD - 0.6mm (0.025").</p>
---------	--

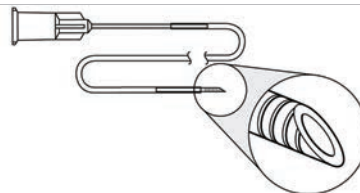

Infusion Cannula

Disposable Infusion Cannulas are available in 20 gauge size with straight shafts and 2.5mm to 6mm wide tips. Comes with 6" silicone tubing. Sold 10 per box.

AXI4824	<p>Infusion Cannula, 2.5mm</p> <p>2.5mm tip, 6" silicone tubing: ID - 0.75mm (0.030"), OD - 1.65 (0.065").</p>
---------	---

AXI4825	<p>Infusion Cannula, 4mm</p> <p>4mm tip, 6" silicone tubing: ID - 0.75mm (0.030"), OD - 1.65 (0.065").</p>
---------	---

AXI4826	<p>Infusion Cannula, 6mm</p> <p>6mm tip, 6" silicone tubing: ID - 0.75mm (0.030"), OD - 1.65 (0.065").</p>
---------	---

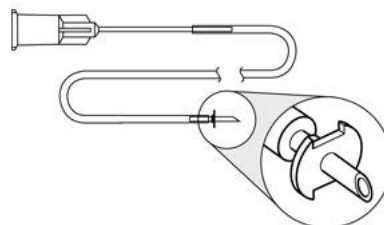

Membrane Micropick [Eaton]

20 gauge, straight shaft, tapered to 30 gauge x 5mm distal end, 0.5mm sharp tip, angled 50 degrees toward bevel. Overall length: 25mm. Disposable, sold 10 per box.

AXI4843	<p>Membrane Micropick, 20g</p>
---------	---------------------------------------

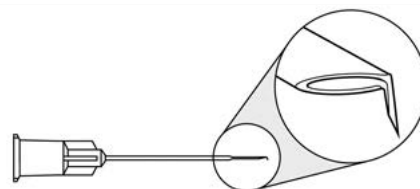

Retinal Backflush Cannula

Retinal Backflush Cannulas are 23 gauge and have either brush or charles flute tips. Straight shaft. Disposable. Sold 5 per box.

AXI5635	<p>Brush Tip Cannula, 23g</p> <p>0.9mm silicone brush tip.</p>
---------	---

AXI5636	<p>Charles Flute Cannula, 23g</p> <p>Blunt tip.</p>
---------	--

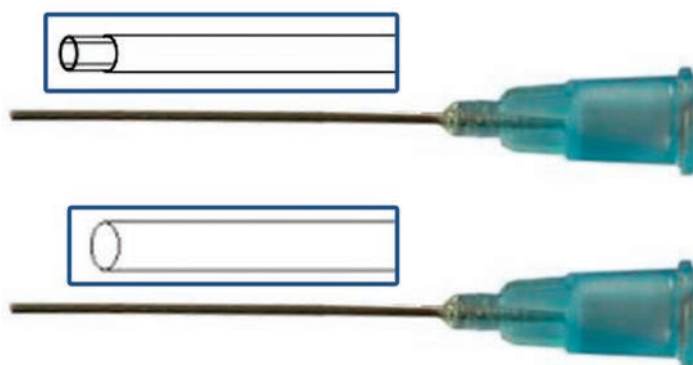

ACCUSURGICAL SINGLE-USE CANNULAS & CYSTOTOMES

Item #	Description	Image
Extrusion Cannula		
Disposable Extrusion Cannulas are available in 19 gauge to 23 gauge sizes with a straight shaft. Comes with a tumble polished edge tip and an overall length of 22mm or 25mm. Sold 10 per box.		
AXI4835	<p>Extrusion Cannula, 19g 19 gauge, tapered tip, tapered to 23 gauge, 4mm from end, 1mm distal end, angled 45 degrees. Overall length: 25mm.</p>	
AXI4832	<p>Extrusion Cannula, 19g 19 gauge, blunt tip. Overall length: 25mm.</p>	
AXI4833	<p>Extrusion Cannula, 19g 19 gauge, tapered tip, tapered to 23 gauge, 4mm from end. Overall length: 25mm.</p>	
AXI4827	<p>Extrusion Cannula, 20g 20 gauge, blunt tip. Overall length: 25mm.</p>	
AXI4828	<p>Extrusion Cannula, 20g 20 gauge, tapered tip, tapered to 25 gauge, 4mm from end. Overall length: 25mm.</p>	
AXI4830	<p>Extrusion Cannula, 20g 20 gauge, tapered tip, tapered to 25 gauge, 4mm from end, 1mm distal end, angled 45 degrees. Overall length: 25mm.</p>	
AXI4837	<p>Extrusion Cannula, 23g 23 gauge, blunt tip, tumble polished edge. Overall length: 22mm.</p>	

ACCUSURGICAL SINGLE-USE CANNULAS & CYSTOTOMES

Item #	Description	Image
Extrusion Cannula with Silicone Tubing		
Disposable Extrusion Cannulas are available in 19 gauge or 20 gauge sizes with a straight or angled shaft. Has a tapered tip with tubing that bends 4mm from end. Overall length of 25mm. Sold 10 per box.		
AXI4834	Extrusion Cannula, Straight 19 gauge, tapered to 23 gauge, straight shaft.	
AXI4836	Extrusion Cannula, Angled 19 gauge, tapered to 23 gauge, angled shaft.	
AXI4829	Extrusion Cannula, Straight 20 gauge, tapered to 25 gauge, straight shaft.	
AXI4831	Extrusion Cannula, Angled 20 gauge, tapered to 25 gauge, angled shaft.	

High Viscosity Fluid Cannula [Peyman]

16 gauge, curved shaft, pointed tip. Overall length: 9mm. Disposable, sold 10 per box.

AXI4838	High Viscosity Fluid Cannula, 16g
---------	--

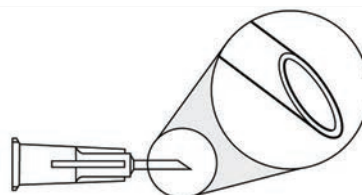

Membrane Dissector [Kingham]

20 gauge, straight shaft, 0.5mm sharp tip, angled 45 degrees toward bevel. Overall length: 25mm. Disposable, sold 10 per box.

AXI4839	Membrane Dissector, 20g
---------	--------------------------------

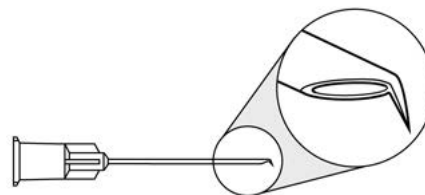

Subretinal Injector [Lambert]

20 gauge, straight shaft, curved, tapered tip, tapered to 33 gauge x 7mm, distal end. Overall length: 25mm. Disposable, sold 10 per box.

AXI4840	Subretinal Injector
---------	----------------------------

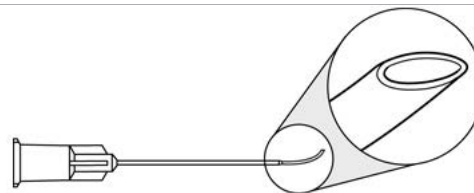

Subretinal Aspirator [Landers]

20 gauge, straight shaft, tapered, angled tip, 2.5mm from bend to tip, tapered to 27 gauge x 6mm. Overall length: 25mm. Disposable, sold 10 per box.

AXI4841	Subretinal Aspirator
---------	-----------------------------

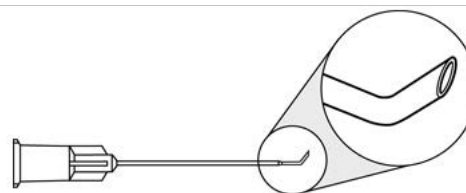

ACCUSURGICAL SINGLE-USE CANNULAS & CYSTOTOMES

Item #	Description	Image
--------	-------------	-------

Vitreoretinal Micropick [Glaser]

Disposable Glaser Vitreoretinal Micropick cannulas are available in either 20 gauge or 23 gauge with straight tapered shafts. Sharp tips measure 0.5mm in width and are angled 50 degrees toward the bevel. Overall length: 25mm. Sold 10 per box.

AXI4844	Vitreoretinal Micropick, 20g 20 gauge, tapered to 25 gauge x 3/16" distal end.
AXI4845	Vitreoretinal Micropick, 23g 23 gauge, tapered to 27 gauge x 3/16" distal end.

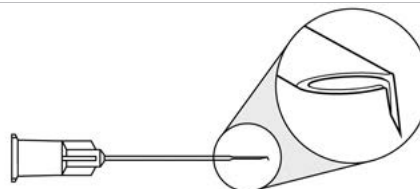

Vitreoretinal Cannula [Vander]

Disposable Vitreoretinal Cannulas are 20 gauge in size with straight shafts that are tapered to 30 gauge. Sold 10 per box.

AXI4846	Straight Vitreoretinal Cannula Straight tapered tip.
---------	--

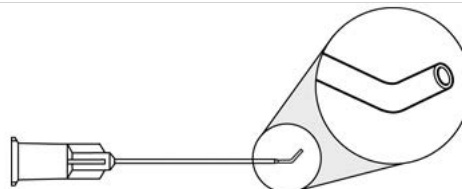

AXI4847	Angled Vitreoretinal Cannula Angled tapered tip.
---------	--

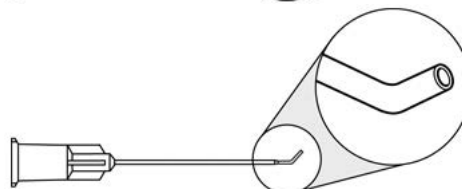

Subretinal Injector [Glaser]

Disposable Glaser Subretinal Injector cannulas come in 20 gauge with a curved or straight shaft. Has a tapered to 33 gauge tip and 3mm distal end. Overall length: 25mm. Sold 10 per box.

AXI4848	Curved Subretinal Injector Curved shaft.
---------	--

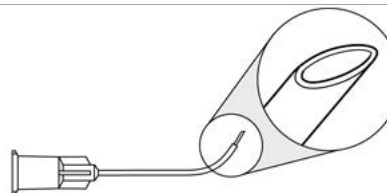

AXI4849	Straight Subretinal Injector Straight shaft.
---------	--

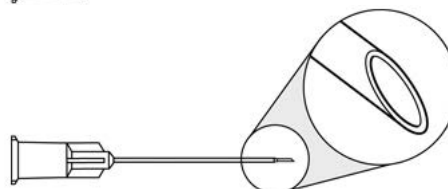

MVR Cannula [Glaser]

20 gauge, angled shaft, 1mm from bend to tip, tapered tip 33 gauge x 4mm, distal end. Overall length: 25mm. Disposable, sold 10 per box.

AXI4850	MVR Cannula, 20g
---------	-------------------------

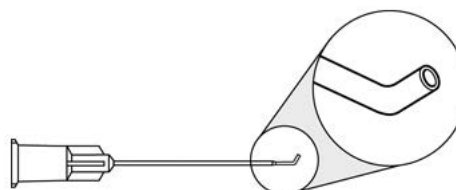

ACCUSURGICAL SINGLE-USE CANNULAS & CYSTOTOMES

Item #	Description	Image
--------	-------------	-------

Subretinal Cannula [Lambert]

20 gauge, straight shaft, curved distal end, tapered to 33 gauge x 7mm. Overall length: 25mm. Disposable, sold 10 per box.

AXI4851 [Subretinal Cannula](#)

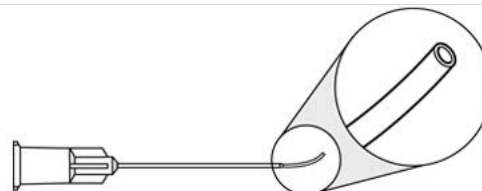

LASIK Cannula [Dishler]

27 gauge, formed shaft, 9mm from bend to tip, rounded closed tip with 4 sideports. Overall length: 16mm. Disposable, sold 10 per box.

AXI4852 [LASIK Cannula, 27g](#)

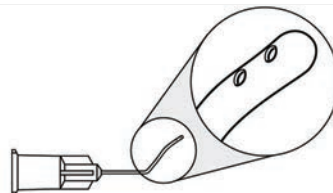

LASIK Cannula [Slade]

26 gauge, formed shaft, 9mm from bend to tip, slanted tip. Overall length: 22mm. Disposable, sold 10 per box.

AXI4853 [LASIK Cannula, 26g](#)

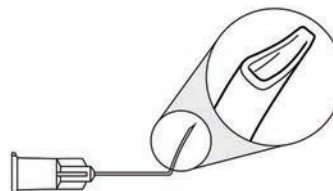

LASIK Cannula [Linn]

25 gauge, angled shafts, 9mm from bend to tip, flat bend, 2 ports, open end. Disposable, sold 10 per box.

AXI4855 [LASIK Cannula, 25g](#)

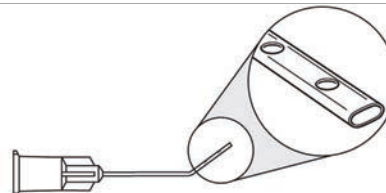

Refractive Cannula

25 gauge, angled shaft, dual shafts, 8 ports, closed tip. Disposable, sold 10 per box.

AX205256 [Refractive Cannula, 25g](#)

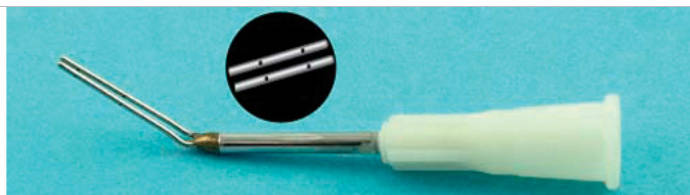

ACCUSURGICAL SINGLE-USE CANNULAS & CYSTOTOMES

Item #	Description	Image
--------	-------------	-------

Femtosecond Cannula [Solomon]

30 gauge hydrodissector, angled shaft, 7mm from bend to tip, sandblasted, oval-shaped tip. Disposable, sold 10 per box.

AXI5227 **Femtosecond Cannula**

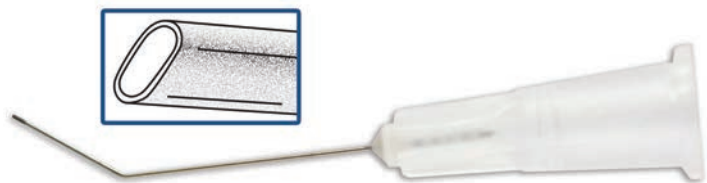

Brody Femtosecond Dissecting Cannula

The Brody Femtosecond Dissecting Cannula for laser-assisted cataract surgery is a disposable 25 gauge stainless steel cannula that both easily opens laser incisions and allows for fast, efficient injection of intraocular lidocaine and/or viscoelastic. This elegant device is placed either on a TB syringe filled with lidocaine or directly on the viscoelastic syringe (for those not using intraocular anesthetic). The shovel-like tip allows for easy and safe opening of both the sideport and the main incision. Single-use design removes the need for sterilization. Combination of spatula and cannula reduces the number of instrument hand-offs between scrub tech and surgeon, saving time and improving efficiency. Unique tip design with 25 gauge width reduces wound stretching when compared to other laser incision instrumentation.

AX20001 **Femtosecond Dissecting Cannula**

Sold 10 per box.

AX20001-BULK **Femtosecond Dissecting Cannula**

Sold 100 per bag.

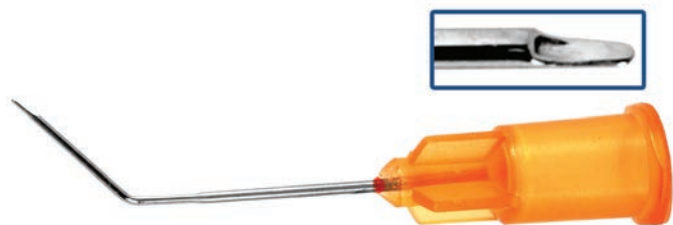

AccuDrop Cannula

AccuDrop is Accutome's dropleless therapy cannula. It was designed by Accutome for administration of dropleless cataract drug formulation. The AccuDrop Cannula is a blunt tip cannula that is designed to reduce zonular trauma. Sideport opening allows for gentle drug dispersion. Angled 90 degree shaft facilitates easier insertion into the anterior chamber to make a targeted drug delivery. Disposable, sold 10 per box.

AXI5581 **AccuDrop Cannula, 25g**

25 gauge.

AXI5630 **AccuDrop Cannula, 27g**

27 gauge.







REUSABLE CANNULAS & CYSTOTOMES







Item #	Description	Image
Atkinson Retrobulbar Needle		
Reusable Atkinson Retrobulbar Needles are available from 19 gauge to 27 gauge in size with straight shafts and sharp, beveled tips. Overall length: 35mm.		
AC0190 19	Atkinson Retrobulbar Needle, 19g 19 gauge.	
AC0190 20	Atkinson Retrobulbar Needle, 20g 20 gauge.	
AC0190 23	Atkinson Retrobulbar Needle, 23g 23 gauge.	
AC0190 25	Atkinson Retrobulbar Needle, 25g 25 gauge.	
AC0190 27	Atkinson Retrobulbar Needle, 27g 27 gauge.	

Air Injection Cannula

Reusable Air Injection Cannulas are available from 23 gauge to 30 gauge in size and have either an angled or straight shaft. Various tip types are available. Overall length: 19mm.

AC0125	Air Injection Cannula, 23g 23 gauge, angled shaft, 45-degree angle, 7mm from bend to tip, blunt tip.	
AC0145	Air Injection Cannula, 25g 25 gauge, angled shaft, 45-degree angle, 5mm from bend to tip, blunt tip.	
AC0110	Air Injection Cannula, 27g 27 gauge, angled shaft, 45-degree angle, 5mm bend to tip.	
AC0122	Air Injection Cannula, 27g 27 gauge, straight shaft.	
AC0105	Air Injection Cannula, 27g 27 gauge, angled shaft, 45-degree angle, 5mm from bend to tip, oval tip.	  

REUSABLE CANNULAS & CYSTOTOMES

Item #	Description	Image
AC0120	Air Injection Cannula, 27g 27 gauge, angled shaft, 45-degree angle, 7mm bend to tip, blunt tip.	
AC0121	Air Injection Cannula, 27g 27 gauge, angled shaft, 8mm bend to tip.	
AC0130	Air Injection Cannula, 30g 30 gauge, angled shaft, 45-degree angle, 5mm bend to tip, blunt tip.	
AC0131	Air Injection Cannula, 30g 30 gauge, straight shaft, blunt tip.	
AC0140	Air Injection Cannula, 30g 30 gauge, angled shaft, 45-degree angle, 7mm bend to tip, blunt tip.	
AC0141	Air Injection Cannula, 30g 30 gauge, angled shaft, 45-degree angle, 8mm bend to tip, blunt tip.	

Gills-Welsh Aspirating Cannula

Reusable 25 gauge Gills-Welsh Aspirating Cannulas have 45-degree angled shafts with blunt, open tips. Various overall lengths and bend size.

AC0320 5	Aspirating Cannula, 5mm Bend 5mm from bend to tip. Overall length: 18mm.	
AC0320 7	Aspirating Cannula, 7mm Bend 7mm from bend to tip. Overall length: 21mm.	
AC0320 8	Aspirating Cannula, 8mm Bend 8mm from bend to tip. Overall length: 21mm.	
AC0320 10	Aspirating Cannula, 10mm Bend 10mm from bend to tip. Overall length: 21mm.	

REUSABLE CANNULAS & CYSTOTOMES

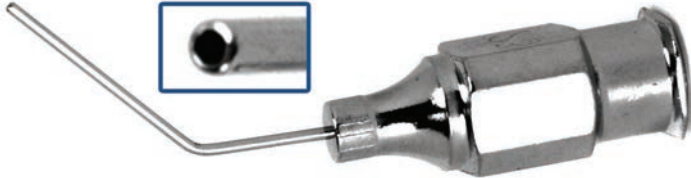
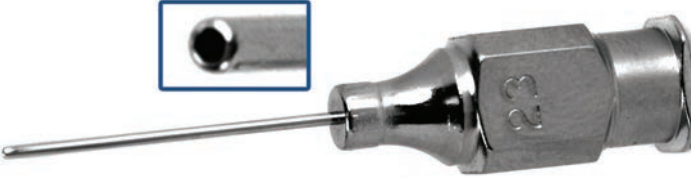
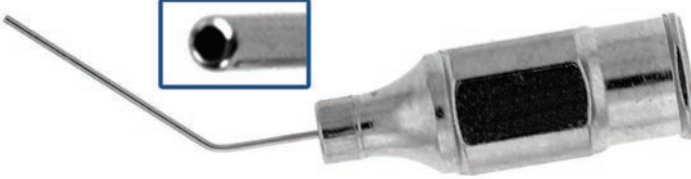
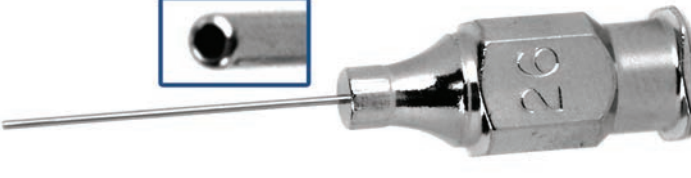
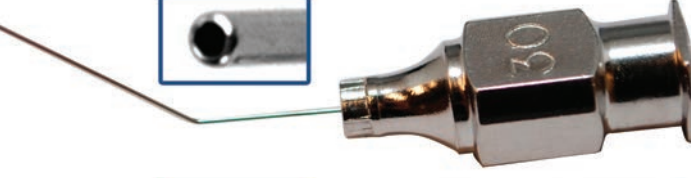
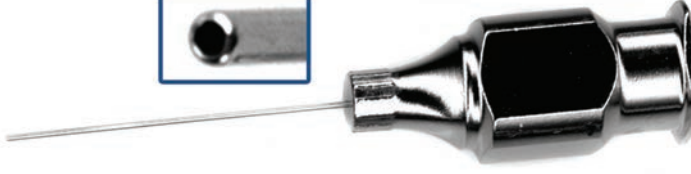
Item #	Description	Image
McIntyre Anterior Chamber Cannula		
Reusable McIntyre Anterior Chamber Cannulas range from 23 gauge to 30 gauge and come in both angled and straight shaft patterns with blunt, open tips. Overall length: 18mm.		
AC0620	<p data-bbox="261 449 464 470">McIntyre Cannula, 23g</p> <p data-bbox="261 485 769 533">23 gauge, angled shaft, 45-degree angle, 12mm from bend to tip.</p>	 <p>The image shows a 23-gauge, angled shaft McIntyre cannula. It features a 45-degree bend in the shaft, with the tip positioned 12mm from the bend. A magnified inset of the tip shows a blunt, open end. The handle is marked with the number '23'.</p>
AC0760	<p data-bbox="261 642 464 663">McIntyre Cannula, 23g</p> <p data-bbox="261 678 477 701">23 gauge, straight shaft.</p>	 <p>The image shows a 23-gauge, straight shaft McIntyre cannula. The shaft is completely straight, ending in a blunt, open tip. A magnified inset of the tip is provided. The handle is marked with the number '23'.</p>
AC0630	<p data-bbox="261 835 464 856">McIntyre Cannula, 26g</p> <p data-bbox="261 871 769 919">26 gauge, angled shaft, 45-degree angle, 12mm from bend to tip.</p>	 <p>The image shows a 26-gauge, angled shaft McIntyre cannula. It features a 45-degree bend in the shaft, with the tip positioned 12mm from the bend. A magnified inset of the tip shows a blunt, open end. The handle is marked with the number '26'.</p>
AC0740	<p data-bbox="261 1029 464 1050">McIntyre Cannula, 26g</p> <p data-bbox="261 1064 477 1087">26 gauge, straight shaft.</p>	 <p>The image shows a 26-gauge, straight shaft McIntyre cannula. The shaft is completely straight, ending in a blunt, open tip. A magnified inset of the tip is provided. The handle is marked with the number '26'.</p>
AC0640	<p data-bbox="261 1222 464 1243">McIntyre Cannula, 30g</p> <p data-bbox="261 1257 769 1306">30 gauge, angled shaft, 45-degree angle, 12mm from bend to tip.</p>	 <p>The image shows a 30-gauge, angled shaft McIntyre cannula. It features a 45-degree bend in the shaft, with the tip positioned 12mm from the bend. A magnified inset of the tip shows a blunt, open end. The handle is marked with the number '30'.</p>
AC0750	<p data-bbox="261 1415 464 1436">McIntyre Cannula, 30g</p> <p data-bbox="261 1451 477 1474">30 gauge, straight shaft.</p>	 <p>The image shows a 30-gauge, straight shaft McIntyre cannula. The shaft is completely straight, ending in a blunt, open tip. A magnified inset of the tip is provided. The handle is marked with the number '30'.</p>

REUSABLE CANNULAS & CYSTOTOMES

Item #	Description	Image
--------	-------------	-------

McIntyre-Binkhorst Irrigating Cannula

Reusable 26 gauge McIntyre-Binkhorst Irrigating Cannulas with angled or straight shafts. Tip is a 2.6mm wide J-shaped tip with a blunt front opening. Overall length: 18mm.

AC0800 **McIntyre-Binkhorst Irrigating Cannula, Right**
26 gauge, angled right shaft, 13mm from bend to tip.

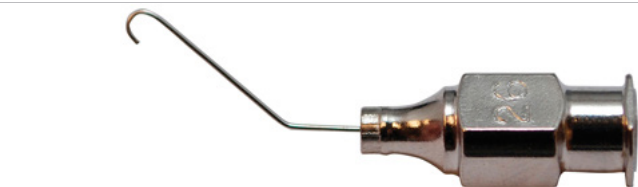

AC0810 **McIntyre-Binkhorst Irrigating Cannula, Straight**
26 gauge, straight shaft.



AC0820 **McIntyre-Binkhorst Irrigating Cannula, Left**
26 gauge, angled left shaft, 13mm from bend to tip.



Bishop-Harmon Irrigating Cannula

Reusable Bishop-Harmon Irrigating Cannulas are available from 18 gauge to 27 gauge in size and have angled or straight shafts. Tips are flattened and blunt. Overall length: 24mm.

AC0230 18 **Bishop-Harmon Irrigating Cannula, 18g**
18 gauge, angled shaft, 35-degree angle, 7mm from bend to tip.



AC0230 19 **Bishop-Harmon Irrigating Cannula, 19g**
19 gauge, angled shaft, 35-degree angle, 7mm from bend to tip.







AC0231 19 **Bishop-Harmon Irrigating Cannula, 19g**
19 gauge, straight shaft.



AC0230 21 **Bishop-Harmon Irrigating Cannula, 21g**
21 gauge, angled shaft, 35-degree angle, 7mm from bend to tip.



REUSABLE CANNULAS & CYSTOTOMES

Item #	Description	Image
AC0230 23	Bishop-Harmon Irrigating Cannula, 23g 23 gauge, angled shaft, 35-degree angle, 7mm from bend to tip.	
AC0230 25	Bishop-Harmon Irrigating Cannula, 25g 25 gauge, angled shaft, 35-degree angle, 7mm from bend to tip.	
AC0230 26	Bishop-Harmon Irrigating Cannula, 26g 26 gauge, angled shaft, 35-degree angle, 7mm from bend to tip.	
AC0230 27	Bishop-Harmon Irrigating Cannula, 27g 27 gauge, angled shaft, 35-degree angle, 7mm from bend to tip.	
AC0231 27	Bishop-Harmon Irrigating Cannula, 27g 27 gauge, straight shaft.	

Bishop-Harmon Irrigating Cannula Bulb

Bishop-Harmon Irrigating Cannula Bulb measures 25mm in diameter, translucent silicone. Overall length: 63mm.

AC0220 **Bishop-Harmon Irrigating Cannula Bulb**



Adapter for Irrigators

Bishop-Harmon Adapter. Adapts to cannula hubs. Plastic, blue material. Overall length: 22mm.

AC0230 A **Bishop-Harmon Adapter**



REUSABLE CANNULAS & CYSTOTOMES

Item #	Description	Image
--------	-------------	-------

Bishop-Harmon Irrigating Cannula Set

Reusable Bishop-Harmon Irrigating Cannula Sets are available from 19 gauge to 25 gauge in size and have angled shafts. Each set includes 1 cannula, 1 adapter for irrigators (AC0230A), and 1 silicone bulb (AC0220).

AC0230 19 CS	Bishop-Harmon Cannula Set, 19g
--------------	---------------------------------------

19 gauge.

AC0230 23 CS	Bishop-Harmon Cannula Set, 23g
--------------	---------------------------------------

23 gauge.

AC0230 25 CS	Bishop-Harmon Cannula Set, 25g
--------------	---------------------------------------

25 gauge.



Cystotome Cannula

Reusable Cystotome Cannulas range from 25 gauge to 27 gauge with angled shafts that are 12mm from bend to tip. Cannulas have small cystotome sharp cutting edge tips and are irrigating. Overall length: 15mm.

AC4175	Cystotome Cannula, 25g
--------	-------------------------------

25 gauge.

AC4174	Cystotome Cannula, 27g
--------	-------------------------------

27 gauge.



Lewicky Cystotome

Angled shaft, 10mm from bend to tip, equilateral triangular tip, blunt base. Round handle. Overall length: 114mm.

AH0305	Lewicky Cystotome
--------	--------------------------



Hydrodissection Cannula

Hydrodissection cannulas ranging in gauge size from 23 gauge to 30 gauge with straight or angled shafts.

AC0460 23	Hydrodissection Cannula, 23g
-----------	-------------------------------------

23 gauge, angled shaft, 35 degree angle 8mm from bend to tip, flattened horizontal tip. Overall length: 22mm.

AC0460	Hydrodissection Cannula, 25g
--------	-------------------------------------

25 gauge, angled shaft, 35 degree angle 8mm from bend to tip, flattened horizontal tip. Overall length: 22mm.

AC0465	Hydrodissection Cannula, 25g
--------	-------------------------------------

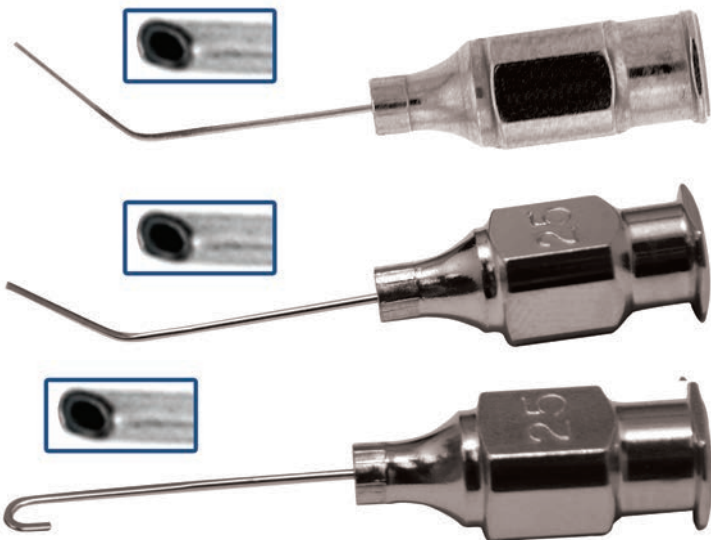

25 gauge, straight shaft, 2.5mm J-shaped tip with 0.3mm flattened tip. Overall length: 18mm.



REUSABLE CANNULAS & CYSTOTOMES

Item #	Description	Image
AC0485	<p>Hydrodissection Cannula, 25g 25 gauge, straight shaft, 3mm wide U-shaped tip. Overall length: 25mm.</p>	
AC0459	<p>Hydrodissection Cannula, 25g 25 gauge, angled shaft, 11mm from bend to tip, flattened tip. Overall length: 22mm.</p>	
AC0462	<p>Hydrodissection Cannula, 25g 25 gauge, angled left shaft, 10mm from bend to tip, 3mm wide U-shaped tip. Overall length: 25mm.</p>	
AC0463	<p>Hydrodissection Cannula, 25g 25 gauge, angled right shaft, 10mm from bend to tip, 3mm wide U-shaped tip. Overall length: 25mm.</p>	
AC0457	<p>Hydrodissection Cannula, 27g 27 gauge, angled shaft, 11mm from bend to tip, flattened tip. Overall length: 22mm.</p>	
AC0467	<p>Hydrodissection Cannula, 27g 27 gauge, straight shaft, J-shaped tip. Overall length: 25mm.</p>	
AC0469	<p>Hydrodissection Cannula, 27g 27 gauge, angled left shaft, 10mm from bend to tip, 3mm wide U-shaped tip. Overall length: 25mm.</p>	
AC0461	<p>Hydrodissection Cannula, 27g 27 gauge, angled shaft, 35-degree angle 8mm from bend to tip, flattened horizontal tip. Overall length: 22mm.</p>	

REUSABLE CANNULAS & CYSTOTOMES

Item #	Description	Image
AC0473	Hydrodissection Cannula, 27g 27 gauge, angled right shaft, 10mm from bend to tip, 3mm wide U-shaped tip. Overall length: 25mm.	
AC0458	Hydrodissection Cannula, 30g 30 gauge, angled shaft, 11mm from bend to tip, flattened tip. Overall length: 22mm.	
AC0466	Hydrodissection Cannula, 30g 30 gauge, straight shaft, J-shaped tip. Overall length: 25mm.	



Akahoshi II Hydrodissection Cannula

27 gauge, curved shaft, 1mm bend to tip, beveled tip. Overall length: 19mm.

AC0478	Akahoshi II Hydrodissection Cannula	
--------	--	--

Chang Nucleus Hydrodissection Cannula

Reusable Chang Nucleus Hydrodissection Cannulas come in 27 gauge with 90-degree angled shafts and flat tips with beveled openings. Overall length: 16mm.

AC0475	1.5mm Chang Hydrodissection Cannula 1.5mm flat standard tip.	
AC0476	3mm Chang Hydrodissection Cannula 3.0mm flat long tip.	

REUSABLE CANNULAS & CYSTOTOMES

Item #	Description	Image
--------	-------------	-------

Simcoe Cortex Extractor Cannula

Reusable 23 and 25 gauge Simcoe Cortex Extractor Cannulas with 13mm and 21mm curved shafts. Cannulas have closed rounded tips with a 0.3mm aspiration port that faces into the shaft. Overall length: 21mm.

ACI030 21	Simcoe Cannula, 23g 23 gauge, 21mm curved shaft.
ACI030 13	Simcoe Cannula, 23g 23 gauge, 13mm curved shaft.
ACI030 25	Simcoe Cannula, 25g 25 gauge, 21mm curved shaft.



Infusion Cannula

Infusion cannulas ranging from 20 gauge to 23 gauge, come with tubing and luer-adapter.

AC0665	Infusion Cannula, 20g 20 gauge, 6mm beveled tip luer-adapter, comes with 26cm tubing.
AC0666	Infusion Cannula, 20g 20 gauge, 4mm beveled tip luer-adapter, comes with 26cm tubing.
AC0675	Infusion Cannula, 22g 22 gauge, angled luer-adapter, 7mm from bend to tip, self-retaining beveled tip, comes with silicone tubing and luer-adapter.
AC2262	Infusion Cannula, 23g 23 gauge, 5mm beveled tip luer-adapter, comes with 26cm tubing.
AC2263	Infusion Cannula, 23g 23 gauge, 6mm beveled tip luer-adapter, comes with 26cm tubing.



Anis Cortex Aspirating Cannula

23 gauge, angled shaft, 35-degree angle, thin wall, 1.5mm from bend to tip, 0.4mm sideport opening, sandblasted tip. Reusable. Overall length: 26mm.

AC0160	Anis Cortex Aspirating Cannula
--------	---------------------------------------



Graether Collar Button Cannula

23 gauge Graether Collar Button Cannulas with straight or curved shafts. Collar button tip with roughened posterior surface.

AC0390	Collar Button Cannula, Straight Straight shaft. Overall length: 25mm.
--------	---



REUSABLE CANNULAS & CYSTOTOMES

Item #	Description	Image
AC0400	<p>Collar Button Cannula, Angled</p> <p>Angled shaft, 45-degree angle, 10mm from bend to tip. Overall length: 22mm.</p>	

Infusion Handle

Reusable Infusion Handles that are made from stainless steel. Available with various connectors and overall lengths.

ACI300	<p>Male Infusion Handle</p> <p>Male to male connector. Overall length: 10cm.</p>	
--------	---	--

ACI305	<p>Female Infusion Handle</p> <p>Male to female luer lock connector. Overall length: 10cm.</p>	
--------	---	--

AC6540	<p>Tubing Infusion Handle</p> <p>Male to tubing connector. Overall length: 7.5cm.</p>	
--------	--	--

ACI301	<p>Tubing Infusion Handle</p> <p>Male to tubing connector. Overall length: 11.5cm.</p>	
--------	---	--

Henderson MICS Capsule Polisher Cannula

23 gauge, curved shaft, 0.3mm port facing down, lightly sandblasted 1.25mm saucer-shaped tip. Overall length: 21mm.

AC2155	<p>Henderson MICS Capsule Polisher Cannula</p>	
--------	---	--

REUSABLE CANNULAS & CYSTOTOMES

Item #	Description	Image
Jensen Capsule Polisher		
Reusable Jensen Capsule Polishers are available in 23 gauge and 25 gauge with curved shafts. Whole capsule and posterior capsule polishers are available with carbide impregnated sandblasted tips. Overall length: 28mm.		
AC2140	Posterior Capsule Polisher, 23g Posterior capsule polisher, 23 gauge.	
AC2130	Posterior Capsule Polisher, 25g Posterior capsule polisher, 25 gauge.	
AC2110	Capsule Polisher, 23g Whole capsule polisher, 23 gauge.	
AC2120	Capsule Polisher, 25g Whole capsule polisher, 25 gauge.	

Gills-Welsh Olive Tip Cannula		
25 gauge, angled shaft, 45-degree angle, 10mm from bend to tip, 1mm stainless steel ball tip. Overall length: 26mm.		
AC0350	Gills-Welsh Olive Tip Cannula	

Lacrimal Cannula		
Lacrimal cannulas ranging from 20 gauge to 27 gauge with various shafts and tips.		
AC0584	Lacrimal Cannula, 20g 20 gauge, straight shaft, blunt closed tip with sideport opening. Overall length: 28mm.	
AC0590	Lacrimal Cannula, 22g 22 gauge, malleable straight shaft, blunt flared probe tip. Overall length: 19mm.	
AC0560	Lacrimal Cannula, 23g 23 gauge, curved 19 gauge reinforced shaft, 10mm tip, open blunt tip. Overall length: 31mm.	
AC0570	Lacrimal Cannula, 23g 23 gauge, straight 19 gauge reinforced shaft, 12mm blunt open tip. Overall length: 32mm.	

REUSABLE CANNULAS & CYSTOTOMES

Item #	Description	Image
AC0580	Lacrimal Cannula, 23g 23 gauge, straight shaft, blunt open tip. Overall length: 25mm.	
AC0583	Lacrimal Cannula, 25g 25 gauge, straight shaft, blunt open tip. Overall length: 25mm.	
AC0560 27	Lacrimal Cannula, 27g 27 gauge, curved 19 gauge reinforced shaft, 10mm tip, open blunt tip. Overall length: 32mm.	
AC0561	Lacrimal Cannula, 27g 27 gauge, straight 19 gauge reinforced shaft, 12mm tip, open blunt tip. Overall length: 32mm.	
AC0582	Lacrimal Cannula, 27g 27 gauge, straight shaft, blunt open tip. Overall length: 25mm.	

Bailey Lacrimal Cannula

Reusable reinforced Bailey Lacrimal Cannulas are available in 23 gauge or 27 gauge with straight, 19 gauge reinforced shafts. Tips are 6mm in size and have a blunt, open end. Overall length: 14mm.

AC0200	Bailey Lacrimal Cannula, 23g 23 gauge.	
AC0201	Bailey Lacrimal Cannula, 27g 27 gauge.	

Fasanella Lacrimal Cannula

Reusable Fasanella Lacrimal Cannulas ranging from 23 gauge to 27 gauge with gently curved reinforced shafts and 22mm open, blunt tips. Overall length: 42mm.

AC0565	Lacrimal Cannula, 23g 23 gauge, 19 gauge reinforced shaft.	
AC0566	Lacrimal Cannula, 25g 25 gauge, 20 gauge reinforced shaft.	
AC0567	Lacrimal Cannula, 27g 27 gauge, 21 gauge reinforced shaft.	

REUSABLE CANNULAS & CYSTOTOMES

Item #	Description	Image
--------	-------------	-------

Simcoe I/A Cannula

23 gauge, curved thin wall shaft, 0.3mm aspiration through top port, irrigation through side opening, comes with 10-inch tubing and luer-lock adapter. Overall length: 15mm.

AC1040

[Simcoe I/A Cannula](#)**Slade LASIK Cannula**





26 gauge, angled shaft, 9mm from bend to tip, flattened spatulated tip with front port opening. Overall length: 16mm.

AC5400

[Slade Cannula, 26g](#)

Capsule Polishers

NON-IRRIGATING CAPSULE POLISHERS

Item #	Description	Image
Accutome Capsule Polishing Sweeper and Curette		
Double-ended, one angled shaft with sweeper tip, 10mm from bend to tip, rounded, teardrop shaped, flat tip, 0.8mm wide. One straight shaft with ring curette, 90 degree angled ring tip, 1.8mm in diameter. Round handle. Overall length: 147mm.		
AH0228	Accutome Capsule Polisher	
Gills-Welsh Capsule Polishing Curette		
Angled shaft, 8mm from bend to tip, 2mm diameter cup tip. Flat handle. Overall length: 121mm.		
AH0130	Gills-Welsh Capsule Curette	
Holladay Posterior Capsule Polisher and Curette		
Straight shaft, 0.5mm diameter tip, sandblasted side on reverse of curette. Round handle. Overall length: 127mm.		
AH0240	Holladay Posterior Capsule	
Nightingale Posterior Capsule Polishing Curette		
Angled shaft, open ring tip, 1.75 diameter, semi-sharp edge. Round handle. Overall length: 124mm.		
AH0220	Nightingale Polishing Curette	
Shepherd Capsule Polishing Curette		
Angled shaft, 10mm from bend to tip, 1.75mm diameter ring tip, semi-sharp top and bottom edges. Flat handle. Overall length: 121mm.		
AH0225	Shepherd Capsule Polisher	

NON-IRRIGATING CAPSULE POLISHERS

Item #	Description	Image
--------	-------------	-------

Singer Sweep Polisher

Double-ended, angled shafts, angled left and right, 10mm from bend to tip, rounded paddle tips, 0.75mm wide tips. Round handle. Overall length: 148mm.

AH7210 [Singer Sweep Polisher](#)



Whitman Sheperd Capsule Polisher

Double-ended, angled shafts, angled left and right, 10mm from bend to tip, low profile ring tips, 1.75mm diameter rings, semi-sharp top and bottom edges of rings. Round handle. Overall length: 145mm.

AH0226 [Whitman Sheperd Polisher](#)



Accutome 360-Degree Capsule Polishing Curette

Angled shaft, 13mm from bend to tip, unique multi-bend tip, 1.60mm diameter ring tip with semi-sharp top and bottom edges. Round handle. Overall length: 121mm.

AH0222 [360-Degree Capsule Polisher](#)



Chalazion Instruments

CURETTES

Item #	Description	Image
Heath Chalazion Ring Curette		
Straight shaft, ring height 1.5mm. Round handle. Overall length: 131mm.		
AH0140	Heath Chalazion Curette, No. 1 1mm diameter ring.	
AH0150	Heath Chalazion Curette, No. 2 2mm diameter ring.	
AH0160	Heath Chalazion Curette, No. 3 3mm diameter ring.	

Meyerhoeffer Chalazion Curette		
Straight 3mm shaft and various cup sizes. Flat handle.		
AH0170	Chalazion Curette, Number 0 Cup 1.5mm cup. Overall length: 125mm.	
AH0180	Chalazion Curette, Number 1 Cup 1.75mm cup. Overall length: 125mm.	
AH0190	Chalazion Curette, Number 2 Cup 2.0mm cup. Overall length: 124mm.	
AH0200	Chalazion Curette, Number 3 Cup 2.5mm cup. Overall length: 124mm.	
AH0210	Chalazion Curette, Number 4 Cup 3.5mm cup. Overall length: 125mm.	

Lens Manipulators & Choppers

LENS MANIPULATORS

Item #	Description	Image
--------	-------------	-------

Anis Ball Tip Nucleus Manipulator

Angled shaft, 10mm from bend to tip, ball tip, 0.5mm diameter tip. Round handle. Overall length: 115mm.

AH4450	Anis Ball Tip Nucleus Manipulator	
--------	---	--



Barrett Duo Nucleus Rotator/Manipulator/Splitter

Titanium, double-ended, angled shafts, 14mm from bend to tip, straight sharp inner/outer sides of splitter tip, cutting edge 90 degrees to axis, 10mm from bend to tip, 0.65mm mushroom tip manipulator. Round handle. Overall length: 121mm.

AH4282	Round Handle Nucleus Rotator	
--------	--	--



Bechert Lens Pusher

Angled shaft, 7mm from bend to tip, Y-shaped tip, vertical rotator tip. Round handle. Overall length: 124mm.

AH1580	Bechert Lens Pusher	
--------	-------------------------------------	--

Bechert Nucleus Rotator

Angled shaft, 7mm from bend to tip, Y-shaped tip. Round handle. Overall length: 120mm.

AH4100	Stainless Steel Rotator	
	Stainless steel handle.	

AH4100T	Titanium Rotator	
	Titanium handle.	

Clayman Nucleus Rotator

Angled shaft, 10mm from bend to tip, V-notched tip, 0.5mm wide flat spatula. Flat handle. Overall length: 121mm.

AH4110	Clayman Nucleus Rotator	
--------	---	--



LENS MANIPULATORS

Item #	Description	Image
--------	-------------	-------

Drysdale Nucleus Manipulator

Angled shaft, 10mm from bend to tip, flattened paddle tip. Round handle.

AH4120	Drysdale Nucleus Manipulator Overall length: 110mm
--------	--

AH4125	Drysdale Manipulator Anterior Anterior capsule polisher. Overall length: 112mm.
--------	---



Fenzel Lens Manipulating Hook

Angled and straight shaft, 0.15mm diameter tip. Round handle.

AH0560	Fenzl Lens Manipulating Hook, Angled Angled shaft, 10mm from bend to tip. Overall length: 115mm.
--------	--

AH0550	Fenzl Lens Manipulating Hook, Straight Straight shaft, T-shaped tip. Overall length: 121mm.
--------	---



Grayson Nucleus Manipulator

Angled shaft, 10mm from bend to tip, 0.8mm flat, olive-shaped tip, flattened with smooth, defined internal edge. Round handle. Overall length: 115mm.

AH4121	Grayson Nucleus Manipulator
--------	------------------------------------



Grayson/Kuglen Double-Ended Manipulator

Double-ended, angled shafts, 10mm from bend to tip, 0.8mm flat olive shaped tip, 9mm from bend to tip, push/pull model, H-shaped. Round handle. Overall length: 140mm.

AH4122	Grayson-Kuglen Double-Ended Manipulator
--------	--



LENS MANIPULATORS

Item #	Description	Image
--------	-------------	-------

Hunkeler IOL Manipulator

Angled shaft, 10mm from bend to tip, slightly curved, 0.3mm diameter hemi-ball tip. Round handle. Overall length: 115mm.

AHI510	Hunkeler IOL Manipulator	
--------	--	---



Jaffe-Bechert Nucleus Rotator

Angled shaft, 9mm from bend to tip, Y-shaped tip. Round handle. Overall length: 120mm.

AH4140	Stainless Steel Rotator Stainless steel handle.	
--------	--	---

AH4140TI	Titanium Rotator Titanium handle.
----------	--



Koch Phacoemulsification Manipulator

Curved shaft, 0.8mm wide, duckbill shaped tip. Round handle. Overall length: 115mm.

AH5380	Koch Phaco Manipulator
--------	--



Koch Stop and Chop Manipulator

Angled shaft, 10mm from bend to tip, 1.5mm long tip. Round handle. Overall length: 118mm.

AH5385	Koch Stop and Chop Manipulator
--------	--











Lester IOL Manipulator

Hourglass/teardrop-shaped tip, 0.25mm tip. Round handle. Overall length: 115mm.

AHI520	Vaulted IOL Manipulator Vaulted shaft, 10mm from bend to tip.	
--------	--	---



LENS MANIPULATORS

Item #	Description	Image
AHI530	Angled IOL Manipulator Angled shaft, 10mm from bend to tip.	 
AHI530T	Angled IOL Manipulator Titanium, angled shaft, 10mm from bend to tip.	 
AHI540	Straight IOL Manipulator Straight shaft.	 
AHI540T	Straight IOL Manipulator Titanium, straight shaft.	 

Lewicky Lens Manipulator Hook

Angled shaft, 9mm from bend to tip, slightly curved, 0.15mm tip. Flat handle. Overall length: 115mm.

AHI140	Lewicky Lens Manipulator Hook	
--------	--------------------------------------	--

Lieberman Microfinger Nucleus Manipulator

Angled shaft, 10mm from bend to tip, unique C-shaped microfinger tip. Round handle. Overall length: 115mm.

AH0860	Right Microfinger Nucleus Manipulator Right-hand use.	
AH0870 C	Left Microfinger Nucleus Manipulator Left-hand use.	

LENS MANIPULATORS

Item #	Description	Image
--------	-------------	-------

Lindstrom STAR Manipulator

Titanium, angled shaft, 12mm from bend to tip, multi-directional cross action star tip. Round handle. Overall length: 117mm.

AH0695T [Lindstrom STAR Manipulator](#)



Mackool Double-Ended Chopper and Spatula

Double-ended, angled shafts, 10mm from bend to tip. Micro 0.38mm ball-shaped blunt tip. Interior cutting edge, 11mm from bend to tip, cylindrical spatula, 0.4mm blade. Round handle. Overall length: 138mm.

AH7125 [Mackool Double-Ended Chopper and Spatula](#)

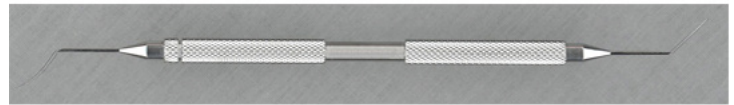

Maloney No Hole IOL Manipulator

Straight shaft, vaulted 7mm from tip, 0.25mm diameter teardrop shaped tip. Round handle. Overall length: 118mm.

AH1550 [Maloney No Hole IOL Manipulator](#)



Maloney Nucleus Rotator

Double-ended, angled shafts, 12mm from bend to tips, 0.5mm spatula tip, 0.6mm forked tip. Round handle. Overall length: 134mm.

AH4135 [Maloney Nucleus Rotator](#)











Maltsman-Fenzel Lens Manipulating Hook

Straight and angled shafts, V-shaped tip, 0.15mm tip. Round handle. Overall length: 118mm.





AH0680 [Maltzman-Fenzl Lens Hook, Straight](#)
Straight shaft.







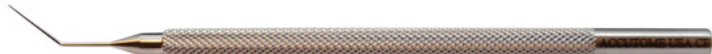

LENS MANIPULATORS

Item #	Description	Image
AH0690	Maltzman-Fenzl Lens Hook, Angled Angled shaft, 10mm from bend to tip.	 
Hunkeler IOL Manipulator		
Angled shaft, hemi-ball tip, 0.3mm diameter tip. Round handle. Overall length: 105mm.		
AH1560	Hunkeler IOL Manipulator	
Masket Phaco Spatula		
Double-ended, angled shafts, 9mm from bend to tip, phaco splitter. 60-degree interior cutting edge, blunt tip, 12mm from bend to tip, cylindrical spatula, flat disc shaped tip. Round handle. Overall length: 136mm.		
AH4300	Masket Phaco Spatula	
Nordan Capsule Elevator		
Angled shaft, used for placing IOL in the bag. Round handle.		
AH1570	Nordan Capsule Elevator	 
O'Gawa Lens Dialer		
Angled shaft, 10mm from bend to tip, collar button style tip. Round handle. Overall length: 118mm.		
AH4220	O'Gawa Lens Dialer	 







LENS MANIPULATORS

Item #	Description	Image
Osher "Y" IOL Hook		
Straight shaft, Y-shaped tip. Round handle. Overall length: 124mm.		
AH0710	Osher "Y" IOL Hook	
Osher Iris Retractor		
Straight shaft, oval button tip. Round handle. Overall length: 121mm.		
AH2135	Osher Iris Retractor	
Osher Nucleus Manipulator		
Straight shaft, blunt finger-like tip, 0.5mm two-prong, K-shaped tip. Round handle. Overall length: 114mm.		
AH0730	Osher Nucleus Manipulator	
Pisacano Nucleus Rotator		
Angled shaft, 10.5mm from bend to tip, 1mm disc shaped tip. Round handle. Overall length: 115mm.		
AH4160	Horizontal Nucleus Rotator Horizontal disc-shaped tip.	
AH4161	Vertical Nucleus Rotator Vertical disc-shaped tip.	

LENS MANIPULATORS

Item #	Description	Image
Rentsch Boat Hook Lens Manipulator		
Straight shaft, split hook tip. Round handle. Overall length: 115mm.		
AH0740	Rentsch Boat Hook Lens Manipulator	
Siepser Endocapsular Controller		
Angled shaft, 12mm from bend to tip, 0.7mm trumpet-shaped tip. Round handle. Overall length: 118mm.		
AH4190	Siepser Endocapsular Controller	
Sinskey C-Hook, Modified		
Curved shaft, 10mm from tip to first bend, offset shaft, 0.2mm diameter tip, blunt. Flat handle. Overall length: 120mm.		
AH1150	Sinskey C-Hook, Modified	
Sinskey Lens Manipulating Hook		
Straight and angled shafts with 0.2mm or 0.25mm diameter blunt tip.		
AH1155	<p data-bbox="256 1339 456 1367">Sinskey Hook, Angled</p> <p data-bbox="256 1373 781 1423">Angled shaft, 12mm from bend to tip, 0.2mm diameter blunt tip reversed. Round handle. Overall length: 115mm.</p>	
AH1160	<p data-bbox="256 1528 456 1556">Sinskey Hook, Angled</p> <p data-bbox="256 1562 781 1612">Angled shaft, 10mm from bend to tip, 0.2mm diameter blunt tip. Round handle. Overall Length: 111mm.</p>	
AH1165	<p data-bbox="256 1724 472 1751">Sinskey Hook, Straight</p> <p data-bbox="256 1757 748 1808">Straight shaft, 0.2mm diameter blunt tip. Round handle. Overall length: 115mm.</p>	

LENS MANIPULATORS

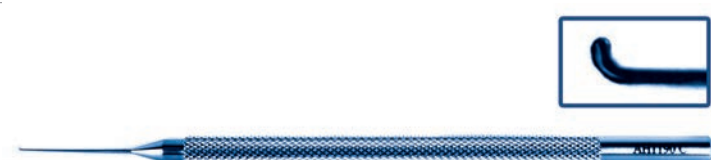
Item #	Description	Image
AH1170	Sinskey Hook, Angled Angled shaft, 10mm from bend to tip, 0.2mm diameter blunt tip. Flat handle. Overall length: 115mm.	
AH1175	Sinskey Hook, Straight Straight shaft, 0.2mm diameter blunt tip. Flat handle. Overall length: 120mm.	
AH1210	Sinskey Hook, Angled Titanium. Angled shaft, 10mm from bend to tip, 0.2mm diameter blunt tip. Round handle. Overall length: 115mm.	
AH1110	Sinskey Hook, Angled Angled shaft, 10mm from bend to tip, 0.25mm diameter blunt tip. Flat handle. Overall length: 115mm.	
AH1200	Sinskey Hook, Angled Angled shaft, 10mm from bend to tip, 0.25mm diameter blunt tip. Round handle. Overall length: 115mm.	
AH1190	Sinskey Hook, Straight Straight shaft, 0.25mm diameter blunt tip. Round handle. Overall length: 120mm.	
AH1190TI	Sinskey Hook, Straight Titanium, straight shaft, 0.25mm diameter blunt tip. Round handle. Overall length: 120mm.	

Tennant Nucleus Manipulator

Angled shaft, 10mm from bend to tip, 0.37mm ball shaped tip. Round handle. Overall length: 118mm.











AH4200	Tennant Nucleus Manipulator	
--------	------------------------------------	--

CHOPPERS

Item #	Description	Image
--------	-------------	-------

Accutome Wand

The Accutome Wands are made from titanium and stainless steel. They are available with straight and angled shafts and curved and angled tips with a 0.5mm diameter ball. Round handle. Overall length: 115mm.

AH7100T	<p>Straight Wand</p> <p>Titanium, straight shaft, curved tip.</p>	 
AH7101	<p>Curved Wand</p> <p>Stainless steel, curved shaft, curved tip.</p>	 
AH7105T	<p>Angled Wand</p> <p>Titanium, angled shaft, 10.0mm from bend to tip.</p>	 
AH7106T	<p>Angled Wand</p> <p>Titanium, angled shaft, 10mm from bend to tip, 90-degree angled tip.</p>	 
AH7107T	<p>Straight Wand</p> <p>Titanium, straight shaft, 90-degree angled tip.</p>	 

Akahoshi Nucleus Sustainer

Angled shaft, 10mm from bend to tip, paddle-shaped blade, right side dished out. Round handle. Overall length: 115mm.

AH7110	<p>Akahoshi Nucleus Sustainer</p>	
--------	--	--

CHOPPERS

Item #	Description	Image
--------	-------------	-------

Ambidextrous Seibel Nucleus Chopper

Angled shaft, 15mm from bend to tip, curved interior cutting edge, 0.5mm olive-shaped tip. Ambidextrous, round handle. Overall length: 117mm.

AH4173	Ambidextrous Seibel Nucleus Chopper	
--------	---	---



Castroviejo Dissector

Angled shaft, 5mm from bend to tip, 1.5mm wide x 5mm flat angled blade. Flat handle. Overall length: 119mm.

AH6545	Castroviejo Dissector	
--------	---------------------------------------	--



Chang Microfinger Phaco Chopper and Quick Chopper

Double-ended, angled shafts, 10mm from bend to tip, C-shaped blunt chopper tip, 1.0mm pointed sharp quick chop tip. Round handle. Overall length: 137mm.

AH4290	Left Chopper Left-hand use.	
--------	--	--

AH4295	Right Chopper Right-hand use.	
--------	--	---

AH4290T	Left Chopper Titanium, left-hand use.	
---------	--	--



Chang-Seibel Microfinger Chopper and Vertical Safety Chopper

Double-ended, angled shafts, 10mm from bend to tips, unique C-shaped microfinger chopper with blunt tip, 0.5mm olive-shaped blade with 1.0mm bend. Round handle. Overall length: 138mm.

AH4289	Right Chopper Right-hand use.	
--------	--	--

AH4288	Left Chopper Left-hand use.	
--------	--	---



Davidoff Ambidextrous Nucleus Chopper

Angled shaft, 10mm from bend to tip, blunt tip, triangle-shaped cutting edge. Ambidextrous use, round handle. Overall length: 115mm.

AH4205	Stainless Steel Davidoff Nucleus Chopper Stainless steel.	
--------	--	--

AH4205T	Titanium Davidoff Nucleus Chopper Titanium.	
---------	--	--



CHOPPERS

Item #	Description	Image
--------	-------------	-------

Dodick-Kammann Nucleus Chopper

Angled shaft, 12mm from bend to tip, 2mm long interior cutting edge, blunt tip. Round handle. Overall length: 112mm.

AH4236 [Dodick-Kammann Nucleus Chopper](#)



Escaf Nucleus Sustainer

Angled shaft, 10mm from bend to tip, smooth ball tip. Round handle. Overall length: 115mm.

AH7130 [Escaf Nucleus Sustainer](#)



Fukasaku Snapper Chopper

Angled shaft, 10mm from bend to tip, blunt tip, wedge shaped interior cutting edge. Round handle. Overall length: 118mm.

AH4210 [Fukasaku Nucleus Chopper](#)



Goldberg Sideport Splitter

Angled shaft, 10mm from bend to tip, 0.8mm flat teardrop shaped tip, blunt. Round handle. Overall length: 113mm.

AH4115 [Goldberg Sideport Splitter](#)



Haefliger Phaco Cleaver

Angled shaft, 10mm from bend to tip, dull, curved cleaver tip. Round handle. Overall length: 115mm.

AH4216 [Haefliger Phaco Cleaver, Right](#)
Right-hand use.

AH4215 [Haefliger Phaco Cleaver, Left](#)
Left-hand use.



CHOPPERS

Item #	Description	Image
--------	-------------	-------

He Hook Chopper

Titanium, angled shaft, 10.5mm from bend to tip, interior cutting edge, hook shaped tip, blunt tip. Round handle. Overall length: 113mm.

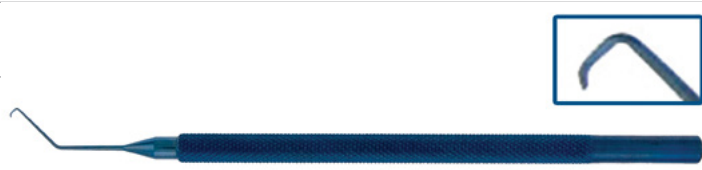
AH4380	Right Hook Chopper Right-hand use.	
AH4381	Left Hook Chopper Left-hand use.	



Keener Lens/Nucleus Divider

One preformed snare wire loop. Round handle. Comes with three additional loops.

AH3215	Nucleus Divider	



Koch Spatula and Nagahara Chopper

Double-ended, curved shaft, 0.8mm wide spatula duckbill-shaped tip, angled shaft, 10mm from bend to tip. 1.5mm, 60-degree chopper cutting edge. Round handle. Overall length: 126mm.

AH4195	Koch Spatula and Nagahara Chopper	



Lieberman Microfinger and Spatula

Double-ended, angled shafts, 10mm from bend to tip. C-shaped chopper, blunt tip, 0.5mm wide flat spatula. Round handle. Overall length: 142mm.

AH0880	Right Microfinger/Spatula Right-hand use.	
AH0890	Left Microfinger/Spatula Left-hand use.	



Mackool Phaco Chopper









Angled shaft, 10mm from bend to tip, micro ball shaped tip, blunt, interior cutting edge. Round handle. Overall length: 114mm.

AH4145	Stainless Steel Chopper Stainless steel.	
AH7115	Titanium Chopper Titanium.	

CHOPPERS

Item #	Description	Image
Mackool Phaco Chopper and Nucleus Chopper		
Double-ended. Round handle.		
AH4375	Mackool Double-Ended Chopper, Right Right-hand use.	
AH4376	Mackool Double-Ended Chopper, Left Left-hand use.	
Maloney Quick-Chop		
Titanium. Double-ended, angled shafts, 9mm from bend to tip, quick-chop tip, 10mm from bend to tip, micro sharp pick tip. Round handle. Overall length: 133mm.		
AH4385T	Maloney Quick-Chop	
Nagahara Fine Chopper and Nichamin Quick Chopper		
Double-ended, 10mm from bend to tips, wedge-shaped cutting edge, fine interior cutting edge, blunt tip. Left-hand use, round handle. Overall length: 140mm.		
AH4182	Nagahara Fine Chopper-Nichamin	
Nagahara Phaco Chopper		
Angled shaft, 45 degrees, 10mm from bend to tip, 1.5mm tip, flat interior cutting edge, 60 degrees. Round handle. Overall length: 114mm.		
AH4240	Stainless Steel Chopper Stainless steel, ambidextrous.	
AH4240TI	Titanium Chopper Titanium, ambidextrous.	
AH4242	Stainless Steel Chopper Stainless steel, right-hand use.	
AH4242T	Titanium Chopper Titanium, right-hand use.	
AH4243	Stainless Steel Chopper Stainless steel, left-hand use.	

CHOPPERS

Item #	Description	Image
Nichamin Double-Ended Nucleus Chopper and Spatula		
Double-ended, wedge-shaped chopper, 0.5mm spatula, blunt tip. Round handle. Overall length: 140mm.		
AH4400	Nichamin Double-Ended Nucleus Chopper and Spatula	
Nichamin Quick Chopper		
Titanium, angled shaft, 10mm from bend to tip, wedge-shaped cutting edge. Round handle. Overall length: 115mm.		
AH4184T1	Nichamin Quick Chopper, Left Left-hand use.	
AH4185T	Nichamin Quick Chopper, Right Right-hand use.	
Nichamin Quick Chopper II		
Vaulted shaft, 10mm from bend to tip, eye-shaped wedged cutting edge, slightly angled tip. Right-hand use, round handle. Overall length: 114mm.		
AH4184	Nichamin II Quick Chopper, Right	 
Nichamin Triple Chopper		
Angled shaft, 10mm from bend to tip, unique multi-directional cutting edge. Round handle. Overall length: 114mm.		
AH4265	Nichamin Triple Chopper	
Nucleus Chopper and Safety Quick Chopper		
Double-ended, angled shafts. One end is angled 15mm from bend to tip with curved interior cutting edge and 0.5mm olive-shaped tip. One end is angled 10mm from bend to tip with 0.5mm olive-shaped blade and 1.0mm bend. Round handle. Overall length: 138mm.		
AH4171T	Titanium Chopper, Right Titanium, right-hand use.	
AH4345	Stainless Steel Chopper, Right Stainless steel, right-hand use.	
AH4172T	Titanium Chopper, Left Titanium, left-hand use.	
AH4346	Stainless Steel Chopper, Left Stainless steel, left-hand use.	

CHOPPERS

Item #	Description	Image
--------	-------------	-------

Rosen Chopper

Angled shaft, 9.0mm from bend to tip, blunt tip, interior cutting edge, wedge-shaped. Round handle. Overall length: 114mm.

AH4170	Stainless Steel Chopper Stainless steel, 45-degree interior cutting edge.	
AH4170TI	Titanium Chopper Titanium, 45-degree interior cutting edge.	
AH4180	Stainless Steel Chopper Stainless steel, 60-degree interior cutting edge.	
AH4180T	Titanium Chopper Titanium, 60-degree interior cutting edge.	

Seibel Nucleus Chopper

Angled shaft, 15mm from bend to tip, curved interior cutting edge, 0.5mm olive-shaped tip. Round handle. Overall length: 117mm.

AH4175	Seibel Nucleus Chopper, Right Right-hand use.	
AH4176	Seibel Nucleus Chopper, Left Left-hand use.	

Seibel Nucleus Chopper and Safety Quick Chopper

Double-ended, angled shafts, 10mm from bend to tips, 0.5mm olive-shaped tips, one quick-chop tip, one curved interior cutting edge tip. Round handle. Overall length: 140mm.

AH4177	Double-Ended Chopper, Right Right-hand use.	
AH4178	Double-Ended Chopper, Left Left-hand use.	

Seibel Safety Quick Chopper

Angled shaft, 10mm from bend to tip, 0.5mm olive shaped tip, 1.0mm bend at tip. Left-hand use, round handle. Overall length: 115mm.

AH4179	Seibel Safety Quick Chopper, Left	
--------	--	--

CHOPPERS

Item #	Description	Image
--------	-------------	-------

Steinert II Nucleus Claw Chopper

Vaulted shaft, 10mm from bend to tip, J-shaped chopper, cutting edge. Ambidextrous, round handle. Overall length: 118mm.

AH4218	Steinert II Nucleus Claw Chopper	
--------	--	---



Sweeney Manipulator Cracker

Angled shaft, 10mm from bend to tip, flat paddle-shaped tip that is spooned out on left side. Round handle. Overall length: 113mm.

AH4126	Stainless Steel Manipulator Cracker Stainless steel.	
--------	---	--

AH4126T	Titanium Manipulator Cracker Titanium.	
---------	---	--





Verges Phaco Chopper

Angled shaft, 12mm from bend to tip, semi-curved centered interior cutting edge, 0.4mm olive-shaped tip. Ambidextrous, round handle. Overall length: 112mm.





AH4275	Verges Phaco Chopper	
--------	--------------------------------------	--

Hooks & Retractors





HOOKS

Item #	Description	Image
Bonn Iris Hook		
Straight shaft, curved 0.3mm hooked tip. Flat handle. Overall length: 123mm.		
AH2100	Bonn Iris Hook	
Clayman Micro Iris Hook		
Angled shaft, 45-degree, 9mm shaft, 0.3mm hook. Flat handle. Overall length: 105mm.		
AH2110	Clayman Iris Hook	
Clayman-Jaffe Lens Manipulating Hook		
Angled shaft, 10mm from bend to tip, 0.15mm diameter blunt tip. Flat handle. Overall length: 115mm.		
AH1100	Clayman-Jaffe Lens Manipulating Hook	
Crawford Retrieving Hook		
Straight shaft, hooked tip. Round handle. Overall length: 143mm.		
AH0905	Crawford Retrieving Hook	
Crawford/Benger Probe Retrieving Hook		
Angled shaft, 10mm from bend to tip, 65mm shaft, used for retrieving the Crawford/Benger intubation probes, flattened J-shaped tip. Round handle. Overall length: 130mm.		
AH7120	Crawford Hook	







HOOKS

Item #	Description	Image
Culler Rectus Muscle Hook		
Straight shaft, flattened hook tip, 7mm hook. Flat handle. Overall length: 125mm.		
AH0605	Culler Rectus Muscle Hook	
Double Fixation Hook		
Straight shaft, double prong hooked tip, sharp tips. Flat handle. Overall length: 128mm.		
AH0530	1.5mm Fixation Hook 1.5mm spread between curved tips.	
AH0540	2mm Fixation Hook 2mm spread between curved tips.	
Fukasaku Snapper Hook		
Angled shaft, 10mm from bend to tip, wedge-shaped flat interior cutting edge, blunt tip, front notch for engaging iris. Round handle. Overall length: 114mm.		
AH1600	Fukasaku Snapper Hook	
Gass Retinal Detachment Hook		
Straight shaft, Graefe hook tip, 13mm hook, 1.5mm oval hole. Flat handle. Overall length: 143mm.		
AH0580	Gass Retinal Detachment Hook	
Graether Collar Button-Handle		
Straight and angled shafts. Iris retractor and capsule polisher with roughened posterior surface. Round handle. Overall length: 116mm.		
AH2120	Graether Collar Button, Angled Angled shaft, 10mm from bend to tip.	









HOOKS

Item #	Description	Image
AH2130	Graether Collar Button, Straight Straight shaft.	
<hr/> Hirschman Iris Hook		
<p>Angled shaft, 45 degree, 9mm from bend to tip, H-shaped 0.75mm hook tip. Round handle. Overall length: 122mm.</p>		
AH2140	Hirschman Iris Hook	
<hr/> Iris Hook		
<p>Straight shaft, blunt curved hook. Flat handle. Overall length: 125mm.</p>		
AH2150	Iris Hook	
<hr/> Jaffe Iris Hook		
<p>Straight shaft, 1.2mm hooked tip, blunt. Flat handle. Overall length: 127mm.</p>		
AH2160	Jaffe Iris Hook	
<hr/> Jaffe Lens Manipulating Hook		
<p>Straight shaft, blunt tip, 0.15mm diameter tip. Flat handle. Overall length: 121mm.</p>		
AH1130	Jaffe Lens Manipulating Hook	

HOOKS

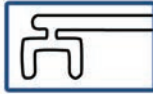
Item #	Description	Image
Jaffe-Maltzman Lens Manipulating Hook		
Angled shaft, 10mm from bend to tip, 0.15mm V-shaped tip. Flat handle. Overall length: 118mm.		
AH0600	Jaffe-Maltzman Lens Hook	 <p>The image shows a Jaffe-Maltzman Lens Manipulating Hook. It features a long, thin, angled shaft with a fine, knurled texture. The tip is a small, V-shaped hook. The handle is flat and extends from the shaft. To the right of the main image is a square icon containing a stylized line drawing of the hook's tip.</p>
Kirby Expressor Double-Ended Hook and Loop		
Double-ended, straight shafts, curved 5mm x 10mm loop, smooth loop, 10mm wide muscle/expressor hook. Round handle. Overall length: 155mm.		
AH3160	Kirby Expressor Double-Ended Hook and Loop	 <p>The image shows a Kirby Expressor Double-Ended Hook and Loop. It has a long, straight shaft with a textured grip in the middle. One end is a curved hook, and the other end is a smooth loop. The handle is round. The shaft has "ACCUTOME" and "AH3160" printed on it.</p>
Kuglen Iris Hook Lens Manipulator		
Straight and angled shafts with either K-hook or push-pull type tips. Round or flat handle options. Overall length: 115mm.		
AH0630	Iris Hook and Lens Manipulator, Angled Angled shaft, push-pull tip, 10mm from bend to tip. Flat handle.	 <p>The image shows an Iris Hook and Lens Manipulator, Angled. It has a long, thin, angled shaft with a fine, knurled texture. The tip is a small, hook-like tip. The handle is flat. To the right of the main image is a square icon containing a stylized line drawing of the hook's tip. The shaft has "ACCUTOME USA, CE" and "AH0630 C" printed on it.</p>
AH0630TI	Iris Hook and Lens Manipulator, Angled Titanium, angled shaft, 10mm from bend to tip, push-pull tip. Round handle.	 <p>The image shows an Iris Hook and Lens Manipulator, Angled. It has a long, thin, angled shaft with a fine, knurled texture. The tip is a small, hook-like tip. The handle is round. To the right of the main image is a square icon containing a stylized line drawing of the hook's tip.</p>
AH0630T	Iris Hook and Lens Manipulator, Angled Titanium, angled shaft, 10mm from bend to tip, push-pull tip. Flat handle.	 <p>The image shows an Iris Hook and Lens Manipulator, Angled. It has a long, thin, angled shaft with a fine, knurled texture. The tip is a small, hook-like tip. The handle is flat. To the right of the main image is a square icon containing a stylized line drawing of the hook's tip.</p>
AH0640	Iris Hook and Lens Manipulator, Straight Straight shaft, push-pull tip. Flat handle.	 <p>The image shows an Iris Hook and Lens Manipulator, Straight. It has a long, thin, straight shaft with a fine, knurled texture. The tip is a small, hook-like tip. The handle is flat. To the right of the main image is a square icon containing a stylized line drawing of the hook's tip. The shaft has "ACCUTOME USA, CE" and "AH0640 C" printed on it.</p>

HOOKS

Item #	Description	Image
AH0650	Iris Hook and Lens Manipulator, Straight Straight shaft, push-pull tip. Round handle.	 
AH0660	Iris Hook and Lens Manipulator, Angled Angled shaft, 10mm from bend to tip, push-pull tip. Round handle.	 
AH0670	Iris Hook and Lens Manipulator, Straight Straight shaft, 0.5mm K-hook. Flat handle.	 
AH0675T	Iris Hook and Lens Manipulator, Angled Titanium, angled shaft, 10mm from bend to tip, push-pull tip. Round handle.	 

Maumenee Iris Hook

Straight shaft, curved hook tip. 1mm blunt tip. Flat handle. Overall length: 121mm.





AH2190	Maumenee Iris Hook	
--------	---------------------------	--

Shepard Iris Hook





Straight shaft, 1mm hooked tip, 1 blunt prong, small. Flat handle. Overall length: 127mm.

AH2230	Shepard Iris Hook	
--------	--------------------------	--



HOOKS

Item #	Description	Image
Sinskey Iris and IOL Hook		
Straight shaft, 0.2mm hooked tip. Flat serrated handle. Overall length: 118mm.		
AH1180	Sinskey Iris and IOL Hook	 A long, thin surgical instrument with a straight shaft and a small, curved hook at the tip. The handle is flat and serrated. The shaft is marked with 'ACCUTOME USA, CE' and 'AH1180 C'. An inset image shows a close-up of the hooked tip.
Smith Expressor Hook		
Straight shaft, curved 11.5mm hooked tip. Flat handle. Overall length: 150mm.		
AH6950	Smith Expressor Hook	 A long, thin surgical instrument with a straight shaft and a large, curved hook at the tip. The handle is flat and has a textured grip. The shaft is marked with 'Smith Expressor Hk'.
Stevens Tenotomy Hook		
Straight shaft, 6mm hook shaped tip, blunt. Flat handle. Overall length: 120mm.		
AH0750	Stevens Tenotomy Hook	 A long, thin surgical instrument with a straight shaft and a hook-shaped tip. The handle is flat. The shaft is marked with 'ACCUTOME USA, CE' and 'AH0750 C'.
Twist Fixation Hook		
Straight shaft, clockwise and counter-clockwise twist hooks. Round handle.		
AH0760	Twist Fixation Hook, 0.3mm Small, 0.3mm, left, counter-clockwise twist hook. Overall length: 110mm.	 A close-up image of a twist fixation hook, showing the sharp, curved tip and the textured handle.
AH0770	Twist Fixation Hook, 0.3mm Small, 0.3mm, right, clockwise twist hook. Overall length: 110mm.	
AH0780	Twist Fixation Hook, 0.5mm Large, 0.5mm, left, counter-clockwise twist hook. Overall length: 127mm.	
AH0790	Twist Fixation Hook, 0.5mm Large, 0.5mm, right, clockwise twist hook. Overall length: 127mm.	



HOOKS

Item #	Description	Image
Tyrell Iris Hook		
Straight shaft, 2mm hooked tip, 1 sharp prong. Flat handle. Overall length: 127mm.		
AH2240	Tyrell Iris Hook	
University of Kansas Spatula and Hook		
Double-ended, 2mm wide x 24mm long spatula tip, malleable, 3mm wide hooked tip, 90 degree angle. Flat handle. Overall length: 124mm.		
AH5360	University of Kansas Spatula and Hook	
Green Strabismus Hook		
Straight shaft, 7mm wide tip, flat-ended hook tip. Flat handle. Overall length: 130mm.		
AH0590	Green Strabismus Hook	
Jameson Muscle Hook		
Straight shaft, 6mm flat hook with bulbous tip. Flat handle. Overall length: 133mm.		
AH0610	2mm Muscle Hook 2mm bulbous tip.	
AH0620	1.5mm Muscle Hook 1.5mm bulbous tip.	
Von Graefe Strabismus Hook		
Straight shaft, flattened hook tip. Flat handle.		
AH0800	Von Graefe Strabismus Hook, Size 1 8mm from hook bend to tip. Overall length: 140mm.	

HOOKS

Item #	Description	Image
AH0810	Von Graefe Strabismus Hook, Size 2 9mm from hook bend to tip. Overall length: 140mm.	
AH0820	Von Graefe Strabismus Hook, Size 3 10mm from hook bend to tip. Overall length: 143mm.	

RETRACTORS

Item #	Description	Image
Berke-Jaeger Lid Plate		
Double-ended stainless steel lid plate, flat with rounded ends, 20mm and 23mm wide blades. Overall length: 109mm.		
AL2110	Berke-Jaeger Lid Plate	
Conway Lid Retractor		
7.5mm wide blade, flat handle. Overall length: 142mm.		
AL2155	Conway Lid Retractor	
Desmarres Lid Retractor		
Wide retractor blade. Flat, serrated handle with polished finish.		
AL2120	Desmarres Lid Retractor, Size 0 11mm wide retractor blade. Overall length: 140mm.	
AL2130	Desmarres Lid Retractor, Size 1 13mm wide retractor blade. Overall length: 137mm.	
AL2140	Desmarres Lid Retractor, Size 2 15mm wide retractor blade. Overall length: 143mm.	
AL2150	Desmarres Lid Retractor, Size 3 17mm wide retractor blade. Overall length: 145mm.	

RETRACTORS

Item #	Description	Image
--------	-------------	-------

Knapp Lacrimal Sac Retractor

Blunt 4mm x 8mm wide 4-prong tip. Flat serrated handle with polished finish. Overall length: 135mm.

AL2180 [Knapp Lacrimal Retractor](#)



Pupil Iris Retractor

4-prong, intraocular handle, curved.

AL3300 [Pupil Iris Retractor](#)



Rizzuti Expressor and Iris Retractor

Double-ended, small retractor blade, 2.5mm wide, muscle hook/lens expressor tip. Round handle. Overall length: 147mm.

AH2210 [Rizzuti Expressor and Iris Retractor](#)



Schepens Orbital Retractor



Smooth 14mm x 56mm blade with 4.5mm wide notch in blade. Flat serrated handle. Overall length: 148mm.

AL2210 [Schepens Orbital Retractor](#)



DSEK Instruments

DSEK

Item #	Description	Image
Carlson DSEK Smoother		
Angled shaft, 7.5mm from bend to tip, 2.5mm ball tip. Round handle. Overall length: 115mm.		
AH7200	DSEK Smoother	
Descemet's DSEK/DSAEK Stripper		
Strongly curved shaft, 15mm from bend to tip, T-shaped tip, 0.75mm in diameter. Round handle. Overall length: 114mm.		
AH7220	DSEK/DSAEK Stripper	
Rosenwasser Endothelial Stripper		
The Rosenwasser Endothelial Stripper, also known as Melles DSAEK PLK Scraper Style 2, has an angled shaft, 11mm from bend to tip, angled 45 degrees and 90-degree angled sandblasted tip. Round handle. Overall length: 125mm.		
AH7202	Rosenwasser Endothelial Stripper	

Fixation Rings & Picks

FIXATION RINGS

Item #	Description	Image
Fine-Thornton Fixation Ring		
Swivel style, open ring, with various degree markings on top of ring. Round, knurled handle. Overall length: 133mm.		
AR0190	13mm Fixation Ring 13mm diameter ring with 10-degree markings on top.	
AR0190TI	13mm Fixation Ring Titanium. 13mm diameter ring with 10-degree markings on top.	
AR0191	13mm Fixation Ring 13mm diameter ring with 15-degree markings on top.	
AR0197	14mm Fixation Ring 14mm diameter ring with 10-degree markings on top.	
AR0200	16mm Fixation Ring 16mm diameter ring with 10-degree markings on top.	

Flieringa Scleral Fixation Ring

Flieringa Scleral Fixation Rings are stainless steel with a polished finish. Various sizes ranging from 12mm to 23mm. Sets are available.

AM0330 12	12mm Scleral Fixation Ring Stainless steel scleral fixation ring set. 12mm in diameter.	
AM0330 13	13mm Scleral Fixation Ring Stainless steel scleral fixation ring set. 13mm in diameter.	
AM0330 14	14mm Scleral Fixation Ring Stainless steel scleral fixation ring set. 14mm in diameter.	
AM0330 15	15mm Scleral Fixation Ring Stainless steel scleral fixation ring set. 15mm in diameter.	
AM0330 16	16mm Scleral Fixation Ring Stainless steel scleral fixation ring set. 16mm in diameter.	
AM0330 17	17mm Scleral Fixation Ring Stainless steel scleral fixation ring set. 17mm in diameter.	
AM0330 18	18mm Scleral Fixation Ring Stainless steel scleral fixation ring set. 18mm in diameter.	
AM0330 19	19mm Scleral Fixation Ring Stainless steel scleral fixation ring set. 19mm in diameter.	
AM0330 20	20mm Scleral Fixation Ring Stainless steel scleral fixation ring set. 20mm in diameter.	
AM0330 21	21mm Scleral Fixation Ring Stainless steel scleral fixation ring set. 21mm in diameter.	
AM0330 22	22mm Scleral Fixation Ring Stainless steel scleral fixation ring set. 22mm in diameter.	
AM0330 23	23mm Scleral Fixation Ring Stainless steel scleral fixation ring set. 23mm in diameter.	
AM0330	Set of 8 Scleral Fixation Rings Stainless steel scleral fixation ring set. This set includes 8 different sized rings that increase in 1.0mm increments. Diameter sizes include: 16mm, 17mm, 18mm, 19mm, 20mm, 21mm, 22mm, and 23mm.	

FIXATION RINGS

Item #	Description	Image
AM0330 SET	<p>Set of 12 Scleral Fixation Rings</p> <p>Stainless steel scleral fixation ring set. This set includes 12 different sized rings that increase in 1.0mm increments. Diameter sizes include: 12mm, 13mm, 14mm, 15mm 16mm, 17mm, 18mm, 19mm, 20mm, 21mm, 22mm, and 23mm.</p>	

Globe Fixation Ring

Fixed style, open ring. 16mm diameter. Concentric grooves on the bottom of ring for fixation of globe. Round handle. Overall length: 133mm.

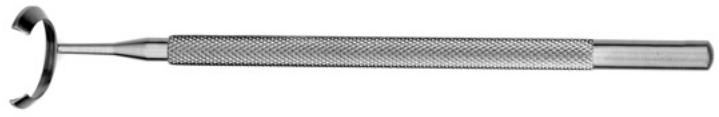
AR0395	Globe Fixation Ring	
--------	----------------------------	--



Thornton Fixation Ring

Fixed style. Overall length: 133mm.



AR0430	<p>Thornton Fixation Ring, Open</p> <p>Open ring. 13mm diameter with 7mm opening. Flat handle.</p>	
--------	---	---

AR0420	<p>Thornton Fixation Ring, Closed</p> <p>Closed ring. 16mm diameter. Round handle.</p>	
--------	---	--

FIXATION PICKS

Item #	Description	Image
Anis Scleral Twist Fixation Cone		
Straight shaft, cone with 2.5mm diameter. Round handle.		
AH0510	Anis Scleral Twist Fixation Cone	 

FIXATION PICKS

Item #	Description	Image
Burch Fixation Pick	Straight shaft, dual pronged tips, sharp tipped, 3.0mm apart. Flat handle. Overall length: 131mm.	
AH0520	Burch Fixation Pick	

Forceps & Clamps

CAPSULE FORCEPS

Item #	Description	Image
--------	-------------	-------

Arruga Capsule Forceps

Vaulted shafts, narrow cup jaws. Flat handle. Overall length: 101mm.

AF0215	Arruga Capsule Forceps, Curved 2.0mm cup jaws.
--------	---

AF0210	Arruga Capsule Forceps, Curved 2.5mm cup jaws.
--------	---



Castroviejo Capsule Forceps

Vaulted, cross-action shafts with 2.5mm cup jaws. Flat handle. Overall length: 105mm.

AF0230	Castroviejo Capsule Forceps
--------	---



Gaskin Fragment Forceps

Angled shafts, 11mm from bend to tip, smooth jaws. Flat handle. Overall length: 108mm.

AF6395	Gaskin Fragment Forceps
--------	---



Kraff Capsule Tag Forceps

Angled shafts, 11mm long jaws with 1.5mm smooth platform. Flat, 3-hole handle. Overall length: 108mm.

AF0250	Kraff Capsule Tag Forceps
--------	---



CAPSULORHEXIS FORCEPS

Item #	Description	Image
--------	-------------	-------

Devgan MICS Capsulorhexis Forceps

Vaulted cross-action shafts. Marks on top of shafts at 2.5mm and 5mm. Very fine Utrata style tips. Round handle. Overall length: 119mm.

AF0365T [Devgan MICS Capsulorhexis Forceps](#)



Gianetti MICS Capsulorhexis Forceps

Vaulted thin shanks, 1.5mm maximum tip spread, extremely small delicate tips. Round handle. Overall length: 101mm.

AF0292 [Gianetti MICS Capsulorhexis Forceps](#)



Gimbel Capsulorhexis Forceps

Angled shafts, 12mm from bend to tip. Fine, serrated grasping tips, jaws set to open only 3mm. Light tension. Flat handle. Overall length: 80mm.

AF0295 [Gimbel Capsulorhexis Forceps](#)



Kellan Capsulorhexis Forceps

Angled shafts, 11mm from bend to tip at 45 Degrees with Arruga style tips. Round knurled handle with guide pin. Overall length: 100mm.

AF0288 [Kellan Capsulorhexis Forceps](#)



Lehner-Utrata Capsulorhexis Forceps

Vaulted shafts, 12mm from bend to tip, delicate grasping tips. Flat handle. Overall length: 82mm.

AF0300 C [Lehner-Utrata Capsulorhexis Forceps](#)



CAPSULORHEXIS FORCEPS

Item #	Description	Image
--------	-------------	-------

Masket Capsulorhexis Forceps

Vaulted 11mm shafts, very delicate triangular tips for grasping capsule. Flat handle. Overall length: 101mm.

AF0340 [Masket Capsulorhexis Forceps](#)



Nevyas Capsulorhexis Forceps

Angled shafts, 12mm from bend to tip. Cystotome shaped tip for puncturing capsule. Flat handle. Overall length: 104mm.

AF0530 [Nevyas Capsulorhexis Forceps](#)



O’Gawa-Utrata Capsulorhexis Forceps

Angled shafts, 12mm from bend to tip. Fine, serrated tips for grasping capsule. Round handle. Overall length: 98mm.

AF0355 [O’Gawa-Utrata Capsulorhexis Forceps](#)



Utrata Capsulorhexis Forceps

Angled and vaulted shafts, serrated and triangular tips for grasping capsule.

AF0290 [Utrata Capsulorhexis Forceps, Angled](#)

Angled shafts, 12mm bend from tip. Fine, serrated tips for grasping capsule. Flat handle. Overall length: 82mm.



AF0290 A [Utrata Capsulorhexis Forceps, Angled](#)

Angled shafts, 12mm bend from tip. Fine, serrated tips for grasping capsule. Flat handle. Overall length: 80mm.



AF0290K [Utrata Capsulorhexis Forceps, Angled](#)



Angled shafts, 12mm bend from tip. Fine, serrated tips for grasping capsule. Flat, 3-hole handle. Overall length: 82mm.





CAPSULORHEXIS FORCEPS

Item #	Description	Image
AF0290TI	<p>Utrata Capsulorhexis Forceps, Angled</p> <p>Titanium. Angled shafts, 11mm bend from tip. Fine, serrated tips for grasping capsule. Flat handle. Overall length: 82mm.</p>	 <p>The image shows a pair of blue-tinted titanium forceps with angled shafts and fine serrated tips. The handle is flat with a textured grip. An inset image shows a close-up of the tips. The text 'AF0290TI CE' is visible on the handle.</p>
AF0299	<p>Utrata Capsulorhexis Forceps, Angled</p> <p>Angled shafts, 12mm bend from tip. Fine, sharp serrated tips for grasping capsule. Flat handle. Overall length 82mm.</p>	 <p>The image shows a pair of stainless steel forceps with angled shafts and fine, sharp serrated tips. The handle is flat with a textured grip. An inset image shows a close-up of the tips. The text 'AF0299 CE' is visible on the handle.</p>
AF0300	<p>Utrata Capsulorhexis Forceps, Angled</p> <p>Angled shafts, 12mm bend from tip. Fine, serrated tips for grasping capsule. Round handle. Overall length: 98mm.</p>	 <p>The image shows a pair of stainless steel forceps with angled shafts and fine serrated tips. The handle is round with a textured grip. An inset image shows a close-up of the tips. The text 'AF0300 CE' is visible on the handle.</p>
AF0300TI	<p>Utrata Capsulorhexis Forceps, Angled</p> <p>Titanium. Angled shafts, 12mm bend from tip. Fine, serrated tips for grasping capsule. Round handle. Overall length: 98mm.</p>	 <p>The image shows a pair of blue-tinted titanium forceps with angled shafts and fine serrated tips. The handle is round with a textured grip. An inset image shows a close-up of the tips. The text 'AF0300TI CE' is visible on the handle.</p>
AF0310	<p>Utrata Capsulorhexis Forceps, Vaulted</p> <p>Vaulted shafts. Fine, serrated tips for grasping capsule. Round handle. Overall length: 98mm.</p>	 <p>The image shows a pair of stainless steel forceps with vaulted shafts and fine serrated tips. The handle is round with a textured grip. An inset image shows a close-up of the tips. The text 'ACCUTOME USA CE' is visible on the handle.</p>
AF0310TI	<p>Utrata Capsulorhexis Forceps, Vaulted</p> <p>Titanium. Vaulted shafts. Fine, serrated tips for grasping capsule. Round handle. Overall length: 98mm.</p>	 <p>The image shows a pair of blue-tinted titanium forceps with vaulted shafts and fine serrated tips. The handle is round with a textured grip. An inset image shows a close-up of the tips. The text 'AF0310TI CE' is visible on the handle.</p>
AF0350	<p>Utrata Capsulorhexis Forceps, Vaulted</p> <p>Vaulted shafts, 12mm bend from tip. Fine, serrated tips for grasping capsule. Cross-action handle. Overall length: 116mm.</p>	 <p>The image shows a pair of stainless steel forceps with vaulted shafts and fine serrated tips. The handle is a cross-action design with a textured grip. An inset image shows a close-up of the tips. The text 'AF0350 CE' is visible on the handle.</p>
AF0290K T	<p>Utrata Capsulorhexis Forceps, Angled</p> <p>Titanium. Angled shafts, 12mm bend from tip. Fine, serrated tips for grasping capsule. Flat, 3-hole handle. Overall length: 101mm.</p>	 <p>The image shows a pair of blue-tinted titanium forceps with angled shafts and fine serrated tips. The handle is flat with three circular holes. An inset image shows a close-up of the tips. The text 'AF0290K T CE' is visible on the handle.</p>

CAPSULORHEXIS FORCEPS

Item #	Description	Image
AF0290L	<p>Utrata Capsulorhexis Forceps, Angled</p> <p>Angled shafts, 12mm from bend to tip, delicate, triangular tips, laser marks on shaft at 2.5mm and 5.0mm. Short, flat 3-hole handle. Overall length: 89mm.</p>	
<p>Utrata MICS Capsulorhexis Forceps</p> <p>Angled shafts, 12mm from bend to tip. Fine, serrated tips for grasping capsule. 1.8mm maximum blade spread. Flat handle. Overall length: 81mm.</p>		
AF0290M	<p>Stainless Steel Capsulorhexis Forceps</p> <p>Stainless steel.</p>	
AF0290M T	<p>Titanium Capsulorhexis Forceps</p> <p>Titanium.</p>	

CHALAZION FORCEPS

Item #	Description	Image
<p>Baird Chalazion Forceps</p> <p>Oval 13mm solid lower plate, 12mm x 8mm open upper plate, locking thumb screw. Flat handle. Overall length: 97mm.</p>		
AF0400	<p>Baird Chalazion Forceps</p>	
<p>Desmarres Chalazion Forceps</p> <p>Solid lower plate with open upper plate, locking thumb screw. Flat handle. Overall length: 89mm.</p>		
AF0410	<p>Desmarres Chalazion Forceps, 24mm</p> <p>24mm solid lower plate, 12mm x 17mm open upper plate.</p>	
AF0411	<p>Desmarres Chalazion Forceps, 30mm</p> <p>30mm solid lower plate, 12mm x 20mm open upper plate.</p>	
<p>Francis Chalazion Forceps</p> <p>17mm lower plate, 12mm x 14mm upper plate, cross-action flat handle. Overall length: 98mm.</p>		
AF0430	<p>Francis Chalazion Forceps</p>	

CHALAZION FORCEPS

Item #	Description	Image
--------	-------------	-------

Heath Chalazion Forceps

Solid oval lower plate, 12mm x 14mm open upper plate, locking thumb screw. Flat handle. Overall length: 98mm.

AF0440 [Heath Chalazion Forceps](#)



Hunt Chalazion Forceps

Solid round lower plate, 12mm open upper plate, locking thumb screw, flat handle. Overall length: 98mm.

AF0450 [Hunt Chalazion Forceps](#)



Lambert Chalazion Forceps

Solid round lower plate, open upper plate, locking thumb screw. Flat handle. Overall length: 92mm.

AF0460 [Lambert Chalazion Forceps, Large](#)
Large, solid round lower plate, 15mm open upper plate.



AF0470 [Lambert Chalazion Forceps, Small](#)
Small, solid round lower plate, 8.0mm open upper plate.



Wies Chalazion Forceps

15mm solid lower plate with 9mm x 12mm open serrated upper plate, locking thumb screw, flat handle.

AF0520 [Wies Chalazion Forceps](#)



CILIA FORCEPS

Item #	Description	Image
--------	-------------	-------

Barraquer Cilia Forceps

Slightly angled shafts, 6mm smooth platform tips. Overall length: 111mm.

AF0800	Flat Handle Forceps Flat handle.
--------	--



AF0801	3-Hole Handle Forceps Flat, 3-hole handle.
--------	--



Cilia Forceps

Straight shafts, 1.0mm x 3.0mm smooth platform tips. Flat handle. Overall length: 75mm.

AF0810	Cilia Forceps
--------	----------------------



Drews Cilia Forceps

Straight, narrow shafts with 7mm long smooth platform. Flat handle. Overall length: 105mm.

AF0820	Drews Cilia Forceps
--------	----------------------------



Gradle Cilia Forceps

Straight shafts, 2mm fine tips. Flat, cross-action handle. Overall length: 95mm.



AF0830	Gradle Cilia Forceps
--------	-----------------------------



CILIA FORCEPS

Item #	Description	Image
Swiss Cilia and Suture Forceps		
Straight shafts, 45-degree 3mm wide jaws. Flat handle. Overall length: 95mm.		
AF0840	Swiss Cilia and Suture Forceps	

CORNEAL FORCEPS

Item #	Description	Image
Castroviejo Colibri Corneal Forceps		
Curved shafts, 0.12mm 1 x 2 teeth set at 45 degrees, 6mm tying platform. Flat, wide handle. Overall length: 108mm.		
AF1110	Stainless Steel Forceps Stainless steel.	
AF1110T	Titanium Forceps Titanium.	

Girard Corneoscleral Forceps

Curved shafts, 1 x 2 teeth set at 90 degrees, 6mm tying platform. Round handle. Overall length: 108mm.		
AF1150	Scleral Forceps, Right Right-hand use, 0.12mm tip.	
AF1160	Scleral Forceps, Left Left-hand use, 0.12mm tip.	
AF1170	Scleral Forceps, Left Left-hand use, 0.3mm tip.	

CORNEAL FORCEPS

Item #	Description	Image
--------	-------------	-------

Hyde Corneal Forceps

Curved shafts, 0.12mm 2 x 2 teeth set at 45 degrees, 6mm tying platform. Flat handle. Overall length: 108mm.

AF1190 [Hyde Corneal Forceps](#)



Katzin-Barraquer Colibri Corneal Utility Forceps

Colibri style. 0.4mm 1 x 2 teeth set at 90 degrees, with 6mm tying platform. Overall length: 73mm.

AF1185 [Corneal Utility Forceps](#)



Pierse Colibri Corneal Forceps

Very delicate 0.11mm 1 x 1 Pierse-type teeth, flat handle. Overall length: 76mm.

AF1240 [Pierse Colibri Corneal Forceps](#)



Polack Colibri Corneal Forceps

Colibri style. Double 0.12mm 1 x 2 teeth separated by 1.0mm and 2.75mm long. Overall length: 70mm.

AF1250 [Polack Colibri Corneal Forceps](#)



Thorpe Corneal Forceps

Straight shafts, 0.12mm 2 x 3 teeth set at 45 degrees, with 5mm tying platform. Flat handle. Overall length: 94mm.



AF1270 [Thorpe Corneal Forceps](#)



CORNEAL FORCEPS

Item #	Description	Image
Troutman-Barraquer Colibri Corneal Forceps		
Colibri style corneal forceps that are available in both stainless steel and titanium options. Forceps have curved shafts and various tip sizes with 1 x 2 teeth sets. Flat handle. Overall length: 76mm.		
AFI295	0.3mm Corneal Forceps 0.3mm teeth set at 90 degrees, 6mm tying platform.	
AFI280	0.5mm Corneal Forceps 0.5mm teeth set at 45 degrees.	
AFI180	0.12mm Corneal Forceps 0.12mm teeth set at 45 degrees, 4.5mm tying platform.	
AFI180TI	0.12mm Titanium Corneal Forceps Titanium, 0.12mm teeth set at 45 degrees, 4.5mm tying platform.	
AFI290	0.12mm Corneal Forceps 0.12mm set at 90 degrees.	
AFI290TI	0.12mm Titanium Corneal Forceps Titanium. 0.12mm teeth set at 90 degrees.	

DSEK FORCEPS

Item #	Description	Image
Charlie II Donor Forceps		
Titanium. Very delicate, angled shafts, extremely thin semi-pointed tips. When tips are closed, there is a 150 micron (0.15mm) gap to keep from cell damage. Round knurled handle with guide pin. Overall length: 105mm.		
AF0285T	Charlie Donor Forceps	
Rossenwasser Donor Lamella Forceps		
Angled/vaulted shafts, 12mm from bend to tip with 2mm thin semi-pointed tips. When tips are closed there is a 150 micron (0.15mm) gap to keep from cell damage. Flat, 3-hole handle. Overall length: 102mm.		
AF0286	Rossenwasser Donor Lamella	





DSEK FORCEPS

Item #	Description	Image
Snyder Stripping Forceps		
Angled shafts, 12mm from bend to tip. Tips pointed upward for grasping of Descemet's Membrane. Flat handle. Overall length: 83mm.		
AF0291	Stripping Forceps	

DRESSING FORCEPS

Item #	Description	Image
Bishop-Harmon Dressing Forceps		
Straight shafts, 0.6mm cross-serrated tips. Flat, 3-hole handle. Overall length: 82mm.		
AF2100	Bishop-Harmon Dressing Forceps	

Dressing Forceps

Straight and curved shafts, 11mm serrated tips. Flat handle. Overall length: 98mm.		
AF2110	Dressing Forceps, Curved Heavy, slightly curved shafts.	
AF2120	Dressing Forceps, Curved Delicate, strong curved shafts.	
AF2140	Dressing Forceps, Straight Delicate, straight shafts.	
AF2130	Dressing Forceps, Curved Delicate, slightly curved shafts.	

DRESSING FORCEPS

Item #	Description	Image
AF2150	Dressing Forceps, Straight Heavy, straight shafts.	

FEMTOSECOND FORCEPS

Item #	Description	Image
Femto LRI Enhancement Forceps		
Cross-action handle with 1.0mm paddles designed to open femtosecond cataract incisions.		
AF6178	Femto LRI Enhancement Forceps	

FIXATION FORCEPS

Item #	Description	Image
Castroviejo Fixation Forceps		
Straight shafts, 0.3mm 1 x 2 teeth, without platforms, wide serrated flat handle. Overall length: 111mm.		
AF2320	Castroviejo Fixation Forceps	

Item #	Description	Image
Fechtner Conjunctiva Forceps		
Straight shafts, delicate ring tips with tying platform. Flat, 3-hole handle. Overall length: 101mm.		
AF1115	Fechtner Conjunctiva Forceps	

FIXATION FORCEPS

Item #	Description	Image
--------	-------------	-------

Graefe Fixation Forceps

Straight shafts, jaws with fine teeth. Flat handle. Overall length: 111mm.

AF2360	4.5mm Graefe Fixation Forceps 4.5mm wide jaws.
--------	--

AF2370	3.5mm Graefe Fixation Forceps 3.5mm wide jaws.
--------	--

AF2380	4.5mm Graefe Fixation Forceps 4.5mm wide jaws, fine teeth with lock.
--------	--



Green Fixation Forceps

Straight shafts, 10mm wide jaws with teeth. Flat handle. Overall length: 98mm.

AF2395	Green Fixation Forceps
--------	-------------------------------



Kremer Corneal Fixation Forceps

Angled shafts, U-shaped double 0.12mm 1 x 2 teeth, separated 13.0mm, with lock. Flat handle. Overall length: 105mm.

AF2400	Kremer Corneal Fixation Forceps
--------	--



Lester Fixation Forceps

Straight shafts, fine 2 x 3 teeth set at 90 degrees, flat handle. Overall length: 95mm.

AF2440	Lester Fixation Forceps
--------	--------------------------------



McGregor Conjunctiva Forceps

Straight shafts, 6mm tying platform. Flat handle: Overall length: 108mm.

AF6950	McGregor Conjunctiva Forceps
--------	-------------------------------------



FIXATION FORCEPS

Item #	Description	Image
Moody Fixation Forceps		
Curved, 0.5mm 1 x 2 teeth, with lock. Flat handle. Overall length: 86mm.		
AF2450	Fixation Forceps, Left Curved left.	
AF2451	Fixation Forceps, Right Curved right.	

Osher Fixation Forceps

0.12mm Elschmig 1 x 2 teeth, delicate tying platform, wide serrated flat handle. Overall length: 105mm.

AF0600	Osher Fixation Forceps	
--------	-------------------------------	--

Thorpe Conjunctiva Forceps



Straight shafts, 2 x 3 teeth set at 90 degrees and tying platform. Flat handle: Overall length: 94mm.

AF2540	Thorpe Conjunctiva Forceps	
--------	-----------------------------------	--

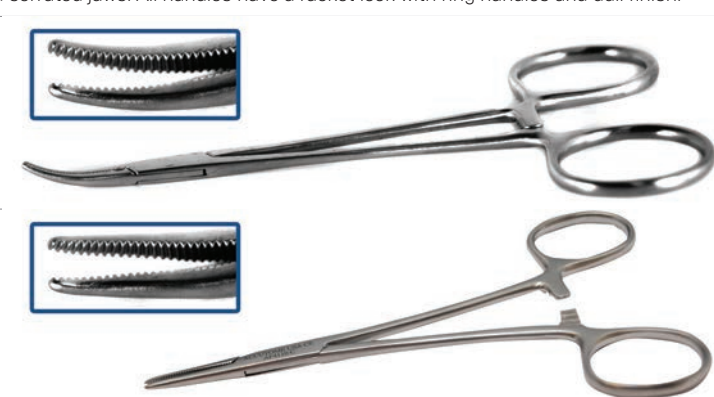
HEMOSTATIC FORCEPS

Item #	Description	Image
Hemostatic Forceps		
Stainless steel hemostatic forceps that are available with both straight and curved serrated jaws. All handles have a ratchet lock with ring handles and dull finish.		
AF4100	Curved Hemostatic Forceps Curved, 22mm serrated jaws. Overall length: 99mm.	
AF4110	Straight Hemostatic Forceps Straight, 22mm serrated jaws. Overall length: 127mm.	

HEMOSTATIC FORCEPS

Item #	Description	Image
AF4120	Curved Hemostatic Forceps Curved, 20mm serrated jaws. Overall length: 99mm.	
AF4130	Straight Hemostatic Forceps Straight, 20mm serrated jaws. Overall length: 99mm.	

Kelly Hemostatic Forceps

Straight and curved shafts with serrated jaws. Ring handle. Overall length: 140mm.

AF0700	Kelly Forceps, Straight Straight shafts.	
--------	--	---

AF0750	Kelly Forceps, Curved Curved shafts.	
--------	--	--

Sponge Forceps

Straight shafts, serrated jaws. Ring handle. Overall length: 178mm.

AF9075	Sponge Forceps	
--------	-----------------------	--

IOL FORCEPS

Item #	Description	Image
--------	-------------	-------

Accutome Folding Forceps

Angled, cross-action shafts. Cradle jaws. Flat handle. Overall length: 97mm.

AF2405	Accutome Folding Forceps	
--------	--	--



Faulkner Lens Holding Forceps

Angled shafts, round smooth polished jaws. Flat, 3-hole handle. Overall length: 114mm.

AF3150	Faulkner Lens Holding Forceps	
--------	---	--



Haberle-McPherson Lens Holding Forceps

Angled shafts, 7.5mm smooth jaws with diagonal groove in tip. Flat, 3-hole handle.

AF3480	Haberle-McPherson Lens Holding Forceps	
--------	--	--



Implant Removal Forceps

Angled, cross-action, thin shafts. Tooth in top jaw with grooves in bottom jaw. Designed to grasp the lens optic or lens segment to efficiently remove from the anterior chamber. Overall length: 120mm.

AF3305	Implant Removal Forceps	
--------	---	--



IOL Lens Loading Forceps

Designed for loading AcrySoft IOL into Monarch II and III Cartridges.

AF8000	IOL Lens Loading Forceps	
--------	--	--



IOL FORCEPS

Item #	Description	Image
--------	-------------	-------

Accutome IOL Lens Loading Forceps

Straight shafts, with smooth, flat jaws. Flat handle.

AF3345	Accutome IOL Lens Loading Forceps
--------	---



Livernois IOL Folding Forceps

Angled shafts, concave jaw surface. Flat, 3-hole handle.

AF3225	Livernois IOL Folding Forceps
--------	---



Livernois IOL Holding Forceps

Livernois IOL Holding Forceps are available in both angled and straight shafts. Rounded jaws that are to be used on soft IOLs. Flat, 3-hole handle. Overall length: 108mm.

AF3230	IOL Forceps, Angled Angled shafts.
--------	---



AF3240	IOL Forceps, Straight Straight shafts.
--------	---



Steinert Folding Forceps

Angled shafts. Flat handle. Overall length: 108mm.

AF3390	Steinert Folding Forceps
--------	--



IOL FORCEPS

Item #	Description	Image
--------	-------------	-------

Universal II IOL Insertion Forceps

Titanium. Cross-action shafts for small incision insertion of second generation foldable IOLs, petite tips, with lock. For thin silicone IOLs.

AF3360	Universal II IOL Insertion Forceps
--------	--



Universal III IOL Insertion Forceps

Titanium. Cross-action shafts for small incision insertion of third generation foldable IOLs, petite tips, with lock. For thin acrylic IOLs.

AF3370	Universal III IOL Insertion Forceps
--------	---



JEWELER FORCEPS

Item #	Description	Image
--------	-------------	-------

Jeweler Forceps

Straight, angled, and curved shafts with fine pointed tips. Smooth handle with dull finish.

AF3700	Jewelers Type Forceps #1 Straight shafts with fine pointed tips. Overall length: 120mm.
--------	--



AF3705	Jewelers Type Forceps #2 Straight shafts with strong, fine pointed tips. Overall length: 120mm.
--------	--







AF3710	Jewelers Type Forceps #3 Straight shafts with extra fine pointed tips. Overall length: 120mm.
--------	--



AF3720	Jewelers Type Forceps #3-C Straight shafts with extra fine pointed tips. Overall length: 110mm.
--------	--



JEWELER FORCEPS

Item #	Description	Image
AF3730	<p>Jewelers Type Forceps #4</p> <p>Straight and narrow shafts with extra fine pointed tips. Overall length: 110mm.</p>	
AF3740	<p>Jewelers Type Forceps #5/45</p> <p>Angled shafts with extra fine pointed tips. Overall length: 120mm.</p>	
AF3750	<p>Jewelers Type Forceps #5</p> <p>Straight, narrow shafts with extra fine pointed tips. Overall length: 120mm.</p>	
AF3760	<p>Jewelers Type Forceps #7</p> <p>Curved shafts with extra fine pointed tips. Overall length: 111mm.</p>	

Suture Removal Forceps

Slightly angled shafts, very fine pointed tips with textured jaws. Smooth, flat handle with dull finish. For wet suture removal. Overall length: 120mm.



AF3775	Suture Removal Forceps	
--------	-------------------------------	--

Jeweler's Type Utility and Splinter Forceps



Short pointed jaws, flat handle. Overall length: 92mm.

AF3765	Utility and Splinter Forceps	
--------	-------------------------------------	--

LASIK FORCEPS

Item #	Description	Image
Buratto LASIK Flap Forceps		
Angled and curved shafts with various tip styles.		
AF3355TI	<p>Titanium Buratto LASIK Flap Forceps</p> <p>Titanium. Angled shafts, curved inward tips, 8mm from bend to tip, 0.5mm blunt round tips. Flat handle. Overall length: 104mm.</p>	
AF3600	<p>Stainless Steel Buratto LASIK Flap Forceps</p> <p>Curved shafts, 0.8mm very delicate disc-shaped tip with serrated jaws. Flat, 3-hole handle. Overall length: 102mm.</p>	

MUSCLE FORCEPS

Item #	Description	Image
Berke Ptosis Forceps		
Berke Ptosis Forceps have a curved tip with straight, longitudinal serrated blades. Flat, serrated handle with slide lock. Available in 20mm or 27mm jaw length.		
AF4320	<p>Ptosis Forceps, 20mm</p> <p>20mm jaw length. Overall length: 98mm.</p>	
AF4310	<p>Ptosis Forceps, 27mm</p> <p>27mm jaw length. Overall length: 104mm.</p>	
Putterman Muscle Forceps		
Titanium. Three pins and holes on each 22mm paddle. Overall length: 95mm.		
AF9050TI	<p>Putterman Muscle Forceps</p>	
Troutman Superior Rectus Forceps		
Angled shafts bent 10mm from tip. 1 x 2 teeth. Wide serrated handle. Overall length: 108mm.		
AF4400	<p>Troutman Superior Rectus Forceps</p>	

PRE-CHOPPER FORCEPS

Item #	Description	Image
--------	-------------	-------

Akahoshi PreChop Forceps

Akahoshi PreChop forceps with straight and angled shafts used for nucleus fragmentation. Cross-action jaws open 3mm wide, extra-pointed tip. Round handle. Overall length: 120mm.

AF7600	PreChop Forceps, Straight Straight shafts.
--------	--



AF7610	PreChop Forceps, Angled Angled shafts.
--------	--



AF7640TI	PreChop Forceps, Straight Titanium. Straight shafts.
----------	--



D&K Salvitti Akahoshi PreChopping Forceps

Straight shafts, reverse cross action. Fits through a 1.7mm incision and spreads 2.5mm wide. Round handle. Overall length: 124mm.

AF7635	Salvitti Akahoshi Forceps
--------	----------------------------------



Dodick Nucleus Cracker

Curved shafts, serrated paddles for cracking nucleus through 3mm incision. Flat, 3-hole, cross-action handle. Overall length: 108mm.

AF3175	Dodick Nucleus Cracker
--------	-------------------------------



Ernest Nucleus Cracker

Angled, cross-action shafts, serrated paddle-shaped jaws. For use through a sub 2mm incision. Flat handle. Overall length: 108mm.

AF3145TI	Ernest Nucleus Cracker
----------	-------------------------------





PRE-CHOPPER FORCEPS

Item #	Description	Image
Salz Nucleus Splitter		
Titanium. Vaulted shafts. Flat handle. Overall length: 76mm.		
AF3177TI	Salz Nucleus Splitter	









RETINAL FORCEPS

Item #	Description	Image
Scleral Plug Forceps		
Curved shafts, cross-action handle. Designed for insertion and removal of plugs. Overall length: 104mm.		
AF5300	Scleral Plug Forceps	



SUTURING FORCEPS

Item #	Description	Image
Bonn Suturing Forceps		
Straight shafts, 0.12mm l x 2 teeth set at 90 degrees, 5mm tying platforms. Narrow, flat handle.		
AF5100	Short Suturing Forceps Short flat handle. Overall length: 74mm.	
AF5110	Long Suturing Forceps Long flat handle. Overall length: 95mm.	
AF5110TI	Long Suturing Forceps Titanium. Long flat handle. Overall length: 95mm.	

SUTURING FORCEPS

Item #	Description	Image
Castroviejo Suturing Forceps		
<p>Castroviejo Suturing Forceps are available in both titanium and stainless steel options with the choice of either straight or angled shafts. Tips have 1 x 2 teeth and vary in tip size and tying platform size. Overall length: 108mm.</p>		
AF5200	<p>Suturing Forceps, 0.3mm Straight shafts, 0.3mm 1 x 2 teeth, 5.5mm tying platform. Wide serrated handle.</p>	
AF5200TI	<p>Titanium Suturing Forceps, 0.3mm Titanium. Straight shafts, 0.3mm 1 x 2 teeth, 5.5mm tying platform. Wide serrated handle.</p>	
AF5170	<p>Suturing Forceps, 0.5mm Straight shafts, 0.5mm 1 x 2 teeth, 5.5mm tying platform. Wide serrated handle.</p>	
AF5140	<p>Suturing Forceps, 0.5mm Angled shafts, 0.5mm 1 x 2 teeth, 6mm tying platform. Wide serrated handle.</p>	
AF5170TI	<p>Titanium Suturing Forceps, 0.5mm Titanium. Straight shafts, 0.5mm 1 x 2 teeth, 5.5mm tying platform. Wide serrated handle.</p>	
AF5160	<p>Suturing Forceps, 0.9mm Straight shafts, 0.9mm 1 x 2 teeth, 5.5mm tying platform. Wide serrated handle.</p>	
AF5150	<p>Suturing Forceps, 0.12mm Straight shafts, 0.12mm 1 x 2 teeth, 5mm tying platform. Wide serrated handle.</p>	
AF5180	<p>Suturing Forceps, 0.12mm Straight shafts, 0.12mm 1 x 2 teeth, 5.5mm tying platform. Wide serrated handle.</p>	

SUTURING FORCEPS

Item #	Description	Image
AF5180K	<p>Suturing Forceps, 0.12mm</p> <p>Straight shafts, 0.12mm 1 x 2 teeth, 5.5mm tying platform. Wide, 3-hole handle.</p>	 <p>A pair of stainless steel suturing forceps with three circular holes in the handle. The shafts are straight with two teeth. An inset image shows a close-up of the jaws.</p>
AF5180TI	<p>Titanium Suturing Forceps, 0.12mm</p> <p>Titanium. Straight shafts, 0.12mm 1 x 2 teeth, 5.5mm tying platform. Wide serrated handle.</p>	 <p>A pair of blue titanium suturing forceps with a serrated handle. The shafts are straight with two teeth. An inset image shows a close-up of the jaws.</p>
AF5190	<p>Suturing Forceps, 1.5mm</p> <p>Straight shafts, 1.5mm 1 x 2 teeth, 5.5mm tying platform. Wide serrated handle.</p>	 <p>A pair of stainless steel suturing forceps with a serrated handle. The shafts are straight with two teeth. An inset image shows a close-up of the jaws.</p>

Fine-Castroviejo Suturing Forceps

Straight shafts, 0.22mm 1 x 2 teeth, 6mm tying platform, narrow flat handle. Overall length: 111mm.

AF5210	<p>Fine-Castroviejo Suturing Forceps</p>	 <p>A pair of fine-castroviejo suturing forceps with a narrow, flat handle and straight shafts. The shafts are thin with two teeth.</p>
--------	---	---

Kelman-McPherson Suturing Forceps

45-degree angled shafts, 1 x 2 teeth. Flat handle. Overall length: 86mm.

AF5225	<p>5mm Kelman-McPherson Forceps</p> <p>5mm tying platform.</p>	 <p>A pair of Kelman-McPherson forceps with 45-degree angled shafts and a flat handle. The shafts have two teeth. An inset image shows a close-up of the jaws.</p>
AF5220	<p>8mm Kelman-McPherson Forceps</p> <p>8mm tying platform.</p>	 <p>A pair of Kelman-McPherson forceps with 45-degree angled shafts and a flat handle. The shafts have two teeth. An inset image shows a close-up of the jaws.</p>

SUTURING FORCEPS

Item #	Description	Image
--------	-------------	-------

Manhattan Eye and Ear Suturing Forceps

Straight shafts, 1 x 2 teeth with 6mm tying platform. Flat handle. Overall length: 86mm.

AF5240	Manhattan Eye and Ear Suturing Forceps
--------	---



O'Gawa Suture Fixation Forceps

O'Gawa Suture Fixation Forceps have straight shafts, round handles, and are available in stainless steel. Tips are available in various sizes and have 1 x 2 teeth with a 5.5mm tying platform.

AF2520	0.13mm Fixation Forceps 0.13mm 1 x 2 teeth. Overall length: 86mm.
--------	---



AF2510	0.3mm Fixation Forceps 0.3mm 1 x 2 teeth. Overall length: 111mm.
--------	--



Paufique Suturing Forceps

Straight shafts, 1 x 2 teeth, 6mm tying platform, wide serrated handle. Overall length: 86mm.

AF5270	Paufique Suturing Forceps
--------	----------------------------------



Stern-Castroviejo Suturing Forceps

Straight shafts, 0.5mm 1 x 2 teeth, 6mm tying platform, wide flat handle with lock. Overall length: 111mm.

AF5290	Stern-Castroviejo Suturing Forceps
--------	---



TISSUE FORCEPS

Item #	Description	Image
--------	-------------	-------

Adson Tissue Forceps

Straight shafts, delicate teeth. Flat handle.

AF6135 **0.5mm Adson Tissue Forceps**
Extra delicate, 1 x 2, 0.5mm teeth. Overall length: 120mm.



AF6137 **0.5mm Adson Tissue Forceps**
Delicate, 2 x 3, 0.5mm teeth. Overall length: 125mm.



AF6136 **1.5mm Adson Tissue Forceps**
Delicate, 1 x 2, 1.5mm teeth. Overall length: 120mm.



Bishop-Harmon Tissue Forceps

Straight shafts with teeth or serrated tips. Flat, 3-hole handle. Overall length: 89mm.

AF6100 **0.3mm Bishop-Harmon Forceps**
0.3mm 1 x 2 teeth.

AF6101 **0.5mm Bishop-Harmon Forceps**
0.5mm 1 x 2 teeth.

AF2105 **0.8mm Bishop-Harmon Forceps**
0.8mm cross serrated tips.

AF6110 **0.8mm Bishop-Harmon Forceps**
0.8mm 1 x 2 teeth.



Hoskins Tissue Forceps

Straight shafts, micro-groove tips. Flat, fenestrated handle. Overall length: 83mm.

AFI400 **Hoskins Forceps #19**
Micro-groove tips.

AFI403 **Hoskins Forceps #28**
Delicate micro-groove tips.



TISSUE FORCEPS

Item #	Description	Image
Tissue Forceps		
Straight shafts, 1 x 2 teeth. Flat handle. Overall length: 98mm.		
AF6130	Delicate Tissue Forceps Delicate 1 x 2 teeth.	
AF6140	Heavy Tissue Forceps Heavy 1 x 2 teeth.	

TYING FORCEPS

Item #	Description	Image
Bechert-McPherson Angled Tying Forceps		
Angled shafts, 10mm tying platform. Narrow serrated handle. Overall length: 86mm.		
AF6300	Stainless Steel Tying Forceps Stainless steel.	
AF6300TI	Titanium Tying Forceps Titanium.	

Castroviejo Tying Forceps

Straight shafts, 5mm tying platform. Flat, wide handle. Overall length: 109mm.

AF6455	Castroviejo Tying Forceps	
--------	----------------------------------	--

Fine Tying Forceps

Curved shafts and tips, smooth, delicate jaws, tying platform tips. Wide serrated handle. Overall length: 108mm.

AF6330	Curved Fine Tying Forceps	
--------	----------------------------------	--

TYING FORCEPS

Item #	Description	Image
--------	-------------	-------

Gerl Tying Forceps

Curved shafts with smooth jaws and 6mm tying platform. Flat handle. Overall length: 86mm.

AF6580 [Gerl Tying Forceps](#)



Girard Fine Tying Forceps

Straight shafts, ultra-fine 0.5mm tying platform. Round handle. Overall length: 100mm.

AF6351 [Girard Fine Tying Forceps](#)



Harms-Tuebingen Tying Forceps

Straight and curved shafts, smooth jaws. Narrow, flat handle. Overall length: 101mm.

AF6370 [Harms-Tuebingen Tying Forceps, Straight](#)
Straight shafts, 6mm tying platform.



AF6360 [Harms-Tuebingen Tying Forceps, Curved](#)
Curved shafts, 7mm tying platform.









Jaffe Tying Forceps

Very delicate, curved, smooth jaws, 6.0mm tying platform. Flat, 3-hole handle. Overall length: 101mm.









AF6380 [Jaffe Tying Forceps](#)



TYING FORCEPS

Item #	Description	Image
Kelman-McPherson Tying Forceps		
Angled shafts. Flat handle. Overall length: 86mm.		
AF6400 S	5mm Tying Forceps 5mm bend from tip, 5mm tying platform. Flat handle.	
AF6400	7.5mm Tying Forceps 8mm bend from tip, 7.5mm tying platform. Flat, 3-hole handle.	
AF6404	7.5mm Tying Forceps 8mm bend from tip, 7.5mm tying platform. Narrow, flat handle.	
AF6400TI	7.5mm Tying Forceps Titanium. 8mm bend from tip, 7.5mm tying platform. Narrow, flat handle.	
McPherson Tying Forceps		
Straight and angled shafts. Flat handle.		
AF6410	McPherson Tying Forceps, Angled Angled shafts, 5mm bend from tip, 5mm tying platform. Flat, 3-hole handle. Overall length: 98mm.	
AF6410S	McPherson Tying Forceps, Angled Angled shafts, 5mm bend from tip, 5mm tying platform. Flat serrated handle. Overall length: 98mm.	
AF6410TI	McPherson Tying Forceps, Angled Titanium. Angled shafts, 5mm bend from tip, 5mm tying platform. Flat serrated handle. Overall length: 98mm.	

TYING FORCEPS

Item #	Description	Image
AF6420	<p>McPherson Tying Forceps, Straight</p> <p>Straight shafts, 5mm tying platform. Flat, 3-hole handle. Overall length: 101mm.</p>	 
AF6420TI	<p>McPherson Tying Forceps, Straight</p> <p>Titanium. 4mm tying platform. Flat handle. Overall length: 86mm.</p>	 
AF6424	<p>McPherson Tying Forceps, Straight</p> <p>Straight shafts, 5mm tying platform. Flat serrated handle. Overall length: 101mm.</p>	 
AF6421	<p>McPherson Tying Forceps, Straight</p> <p>Straight shafts, 5mm tying platform. Flat, narrow, serrated handle. Overall length: 86mm.</p>	 

O’Gawa Tying Forceps

Curved shafts, 5.5mm tying platform, 0.3mm gap at platform heel. Round, knurled handle. Overall length: 108mm.







AF6430	<p>Curved Tying Forceps</p>	
--------	------------------------------------	--

O’Gawa-Castroviejo Tying Forceps

Straight shafts, 6mm tying platform tips. Wide serrated handle. Overall length: 111mm.

AF6450	<p>Straight Tying Forceps</p>	
--------	--------------------------------------	--

TYING FORCEPS

Item #	Description	Image
Sheets-McPherson Tying Forceps		
45-degree angled shafts, 10.5mm tying platform. Serrated criss-cross tips. Flat handle. Overall length: 86mm.		
AF6470	Sheets-McPherson Tying Forceps	
Tennant Tying Forceps		
Tennant Tying Forceps with both straight and curved shafts. Delicate and extra delicate tips with 6mm tying platform. Round handle with guide pin.		
AF6350	Tennant Tying Forceps, Straight Straight shafts, extra delicate. Overall length: 101mm.	
AF6350TI	Tennant Tying Forceps, Straight Titanium. Straight shafts, extra delicate. Overall length: 101mm.	
AF6355	Tennant Tying Forceps, Curved Curved shafts, delicate. Overall length: 98mm.	
AF6355T	Tennant Tying Forceps, Curved Titanium. Curved shafts, delicate. Overall length: 110mm.	
AF6530	Tennant Tying Forceps, Curved Curved shafts, extra delicate. Overall length: 98mm.	

UTILITY FORCEPS

Item #	Description	Image
--------	-------------	-------

Alabama University Utility Forceps

Straight shafts, fitted V-groove jaws. Flat handle. Overall length: 92mm.

AF6700	Alabama University Utility Forceps
--------	--



Bonaccolto Utility Forceps

Straight shafts, with serrated tips. Flat, narrow handle. Overall length: 111mm.

AF6720	1.2 Utility Forceps 1.2 x 16mm jaws.
--------	---

AF6710	1.7 Utility Forceps 1.7 x 17mm jaws.
--------	---

AF6730	2.4 Utility Forceps 2.4 x 16mm jaws.
--------	---



Gill Iris Forceps

Curved shafts, delicate, cross-serrated jaws, flat handle. Overall length: 70mm.

AF3540	Gill Iris Forceps
--------	-----------------------------------



Kennerdell Bayonet Forceps

Bayonet shafts with 17mm serrated tips, 83mm bend from tip. No teeth. Overall length: 160mm.

AF6930	Kennerdell Bayonet Forceps
--------	--



Nugent Utility Forceps

Nugent stainless steel utility forceps have angled shafts with 45-degree angled jaws. Jaws are available in both serrated and smooth and are 10mm long. Flat, narrow handle. Overall length: 108mm.

AF6760	Serrated Utility Forceps Serrated tips.
--------	--



UTILITY FORCEPS





Item #	Description	Image
AF6770	Smooth Utility Forceps Smooth tips.	

Wills Hospital Utility Forceps

Straight shafts with 13mm long criss-cross serrated tips, narrow handle. Overall length: 111mm.









AF6780	Wills Hospital Utility Forceps	
--------	---------------------------------------	--

CLAMPS





Item #	Description	Image
Clamp		
Various brands of towel clamps with different types of tips and handles.		
AF6900	Baby Jones Towel Clamp Curved shafts, sharp pointed tips. 2 1/2" cross-action flat handle. Overall length: 55mm.	
AF6910	Long Towel Clamp Forceps Curved shafts, sharp pointed tips. Ring handle. Overall length: 133mm.	
AM0560	Serrefine Clamp Straight shafts, stainless steel, 10mm serrated jaws. Flat handle. Overall length: 36mm.	
AF6920	Short Towel Clamp Forceps Curved shafts, sharp pointed tips. Ring handle. Overall length: 89mm.	

I/A & Bimanual Handpieces



DISPOSABLE I/A INSTRUMENTS

Item #	Description	Image
Bimanual I/A System		
Single-use bimanual I/A systems are a solution for preventing infection. These products are guaranteed to be sterile and safe from contaminants. Comes two handpieces per pack, one irrigating, one aspirating. Aspiration-handpiece 0.8 mm [21g] with curved cannula, aspiration port 0.35 mm, textured tip for capsule polishing AEROPLANE nose shape. Irrigation-handpiece 0.8 mm [21G] with curved cannula. Sold 10 per box.		
AB-9105B	Single Port I/A System Open ended irrigation port 0.50 mm for active rinsing.	
AB-9110B	Dual Port I/A System Two irrigation ports 0.45 mm.	
Mono-Manual I/A System		
This range of coaxial I/A systems features straight and angled versions at 30 degrees, 45 degrees, and 65 degrees. All models are available as 19g, 20g, 21g, and 23g versions for incisions of 2.8mm to 1.8 mm. The textured aspiration tips can be used for selective polishing of the posterior capsule. Sold 10 per box.		
AB-9170P	I/A Handpiece, 1.8mm Aspiration cannula angled 45 degrees, for incisions of 1.8mm, polished aspiration head.	
AB-9175P	I/A Handpiece, 1.8mm Aspiration cannula curved, for incisions of 1.8mm, polished aspiration head.	
AB-9155P	I/A Handpiece, 2.2mm Aspiration cannula angled 45 degrees, for incisions of 2.2mm, polished aspiration head.	
AB-9160P	I/A Handpiece, 2.2mm Aspiration cannula curved, for incisions of 2.2mm, polished aspiration head.	
AB-9115	I/A Handpiece, 2.5mm Aspiration cannula straight, for incisions of 2.5mm, textured aspiration head.	
AB-9125P	I/A Handpiece, 2.5mm Aspiration cannula angled 45 degrees, for incisions of 2.5mm, polished aspiration head.	







DISPOSABLE I/A INSTRUMENTS

Item #	Description	Image
AB-9135	I/A Handpiece, 2.5mm Aspiration cannula angled 65 degrees, for incisions of 2.5mm, textured aspiration head.	
AB-9110	I/A Handpiece, 2.8mm Aspiration cannula straight, for incisions of 2.8mm, textured aspiration head.	
AB-9120	I/A Handpiece, 2.8mm Aspiration cannula angled 45 degrees, for incisions of 2.8mm, textured aspiration head.	
AB-9130	I/A Handpiece, 2.8mm Aspiration cannula angled 65 degrees, for incisions of 2.8mm, textured aspiration head.	

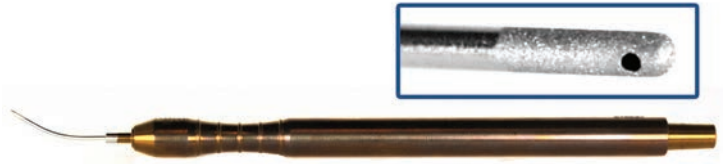
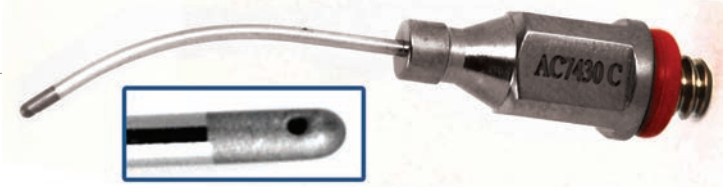
REUSABLE I/A INSTRUMENTS

Item #	Description	Image
Bimanual Aspirating Unit		
Reusable Bimanual Aspirating Units come in 21 gauge or 23 gauge cannula tips size options. Each cannula tip has a curved shaft with a single 0.3mm port and closed round tip. Aspirating handle is titanium. Overall length: 111mm.		
AC7032	Bimanual Aspirating Unit, 21g 21 gauge, smooth cannula tip.	
AC7030	Bimanual Aspirating Unit, 21g 21 gauge, sandblasted capsule polisher tip.	
AC7100	Bimanual Aspirating Unit, 23g 23 gauge, smooth cannula tip.	

REUSABLE I/A INSTRUMENTS

Item #	Description	Image
AC7110	Bimanual Aspirating Unit, 23g 23 gauge, sandblasted capsule polisher tip.	 A long, thin, gold-colored instrument with a curved tip. An inset shows a close-up of the sandblasted tip with a small hole.
Bimanual Aspiration Cannula Tip		
Reusable Bimanual Aspiration Cannula Tips come in 21 gauge or 23 gauge with a curved shaft. This is only the tip not the whole unit. Each tip has a sandblasted capsule polisher tip with a single 0.3mm sideport. Overall length: 21mm.		
AC7430	Bimanual Aspiration Tip, 21g 21 gauge.	 A curved, silver-colored tip with a handle. An inset shows a close-up of the sandblasted tip with a sideport. The handle has 'AC7430 C' engraved on it.
AC7431	Bimanual Aspiration Tip, 23g 23 gauge.	
Bimanual Irrigating Unit		
Reusable Bimanual Irrigating Units come in 21 gauge or 23 gauge cannula tips size options. Each cannula tip has a straight or curved shaft and various tip types. Irrigating handle is titanium. Overall length: 111mm.		
AC7000	Bimanual Irrigating Unit, 21g 21 gauge cannula tip, straight shaft, open ended.	 A long, blue handle with a straight, open-ended cannula tip. An inset shows the tip's open end.
AC7010	Bimanual Irrigating Unit, 21g 21 gauge cannula tip, curved shaft, open ended.	 A long, blue handle with a curved, open-ended cannula tip. An inset shows the tip's open end.
AC7040	Bimanual Irrigating Unit, 21g 21 gauge cannula tip, straight shaft, 0.5mm dual ports, closed rounded tip.	 A long, blue handle with a straight shaft and a closed, rounded tip. An inset shows the tip's closed end. The handle has 'ACUTOME USA' and 'AC7040 C' engraved on it.
AC7050	Bimanual Irrigating Unit, 21g 21 gauge cannula tip, curved shaft, 0.5mm dual ports, closed rounded tip.	 A long, blue handle with a curved shaft and a closed, rounded tip. An inset shows the tip's closed end. The handle has 'ACUTOME USA' and 'AC7050 C' engraved on it.
AC7130	Bimanual Irrigating Unit, 23g 23 gauge cannula tip, thin wall, curved shaft, 0.4mm dual ports, closed rounded tip.	 A long, blue handle with a curved shaft and a closed, rounded tip. An inset shows the tip's closed end. The handle has 'ACUTOME USA' and 'AC7130 C' engraved on it.

REUSABLE I/A INSTRUMENTS

Item #	Description	Image
AC7120	Bimanual Irrigating Unit, 23g 23 gauge cannula tip, thin wall, straight shaft, 0.4mm dual ports, closed rounded tip.	 A blue bimanual irrigating unit with a straight shaft and a closed rounded tip. An inset image shows a close-up of the tip. The handle has 'ACCUTOME USA' and 'C' printed on it.

Bimanual Irrigation Cannula Tip

Reusable Bimanual Irrigation Cannula Tips come in 21 gauge or 23 gauge with a curved shaft. This is only the tip not the whole unit. Various tip types are available. Overall length: 21mm.

AC7450	Bimanual Irrigation Tip, 21g 21 gauge, 0.5mm dual ports, closed rounded tip.	 A blue bimanual irrigation tip with a curved shaft and a closed rounded tip. An inset image shows a close-up of the tip. The handle has 'ACCUTOME USA' and 'C' printed on it.
--------	--	--

AC7451	Bimanual Irrigation Tip, 23g 23 gauge, thin wall, 0.4mm dual ports, closed rounded tip.	 A blue bimanual irrigation tip with a curved shaft and a closed rounded tip. An inset image shows a close-up of the tip. The handle has 'ACCUTOME USA' and 'C' printed on it.
--------	---	---

AC7530	Bimanual Irrigation Tip, 23g 23 gauge, thin wall, 0.4mm dual oval ports, closed rounded tip.	 A blue bimanual irrigation tip with a curved shaft and a closed rounded tip. An inset image shows a close-up of the tip. The handle has 'ACCUTOME USA' and 'C' printed on it.
--------	--	--

Donnenfeld Irrigating Hook

Designed in conjunction with Eric D. Donnenfeld, M.D., specifically for the placement of Toric IOLs. The stainless steel Donnenfeld Irrigating Hook is 23 gauge and has two irrigating ports that are positioned at the tip of the instrument, which open the capsular bag allowing the surgeon to rotate the Toric IOL. The hook on the bottom of the instrument gently grabs the haptic for rotation.









AC8000	Donnenfeld Irrigating Hook	 A stainless steel Donnenfeld Irrigating Hook with a curved shaft and a hook at the tip. An inset image shows a close-up of the hook. The handle has 'ACCUTOME USA' and 'C' printed on it.
--------	-----------------------------------	--

I/A Handpiece









Please note that titanium handles are only interchangeable with titanium tips and stainless handles are only interchangeable with stainless tips. Replacement O-ring sets are also available for both stainless and titanium products. Please note that silicone sleeves are not included with tips.

AC5120	Stainless Steel I/A Handpiece Male aspiration connector in stainless steel.	 A stainless steel I/A handpiece with a male aspiration connector. The handle has 'AC5120 C' printed on it.
--------	---	---





REUSABLE I/A INSTRUMENTS

Item #	Description	Image
AC5120T	Titanium I/A Handpiece Male aspiration connector in titanium.	
I/A Tip		
Please note that titanium handles are only interchangeable with titanium tips and stainless handles are only interchangeable with stainless tips. Replacement O-ring sets are also available for both stainless and titanium products. Please note that silicone sleeves are not included with tips.		
AC5215	Coaxial I/A Tip, Straight Coaxial I/A tip with straight shaft and tip. 0.5mm dual sideport aspiration and 16g irrigation sleeve.	
AC5141T	Coaxial I/A Tip, Straight Titanium, coaxial I/A tip with straight shaft and tip. 0.5mm dual sideport aspiration and 16g irrigation sleeve.	
AC5235T	Coaxial I/A Tip, Straight Titanium, 2lg, coaxial I/A tip with straight shaft and tip. 0.3mm dual sideport aspiration. Made for use with silicone irrigation sleeve (sold separately).	
AC5235	Coaxial I/A Tip, Straight 2lg, coaxial I/A tip with straight shaft and tip. 0.3mm dual sideport aspiration. Made for use with silicone irrigation sleeve (sold separately).	
AC5140	Coaxial I/A Tip, Curved Coaxial I/A tip with straight shaft and tip. 0.3mm dual sideport aspiration and 16g irrigation sleeve.	
AC5140T	Coaxial I/A Tip, Curved Titanium, coaxial I/A tip with straight shaft and tip. 0.3mm dual sideport aspiration and 16g irrigation sleeve.	
AC5150	Coaxial I/A Tip, Curved Coaxial I/A tip with curved shaft and straight tip. 0.3mm dual sideport aspiration and 16g irrigation sleeve.	

REUSABLE I/A INSTRUMENTS



Item #	Description	Image
AC5150T	Coaxial I/A Tip, Curved Titanium, coaxial I/A tip with curved shaft and straight tip. 0.3mm dual sideport aspiration and 16g irrigation sleeve.	
AC5151	Coaxial I/A Tip, Curved Coaxial I/A tip with curved shaft and straight tip. 0.5mm dual sideport aspiration and 16g irrigation sleeve.	
AC5151T	Coaxial I/A Tip, Curved Titanium, coaxial I/A tip with curved shaft and straight tip. 0.5mm dual sideport aspiration and 16g irrigation sleeve.	
AC5245	Coaxial I/A Tip, Curved 2lg coaxial I/A tip with curved shaft and tip. 0.3mm dual sideport aspiration. Made for use with silicone irrigation sleeve (sold separately).	
AC5245T	Coaxial I/A Tip, Curved Titanium, 2lg, coaxial I/A tip with curved shaft and tip. 0.3mm dual sideport aspiration. Made for use with silicone irrigation sleeve (sold separately).	
AC5160	Coaxial I/A Tip, 45 degrees Coaxial I/A tip with straight shaft and 45-degree angled tip. 0.3mm dual sideport aspiration and 16g irrigation sleeve.	
AC5160T	Coaxial I/A Tip, 45 degrees Titanium, coaxial I/A tip with straight shaft and 45-degree angled tip. 0.3mm dual sideport aspiration and 16g irrigation sleeve.	
AC5220	Coaxial I/A Tip, 45 degrees 2lg, coaxial I/A tip with straight shaft and 45-degree angled tip. 0.3mm dual sideport aspiration. Made for use with silicone irrigation sleeve (sold separately).	

REUSABLE I/A INSTRUMENTS

Item #	Description	Image
AC5220T	<p>Coaxial I/A Tip, 45 degrees</p> <p>Titanium, 2lg, coaxial I/A tip with straight shaft and 45-degree angled tip. 0.3mm dual sideport aspiration. Made for use with silicone irrigation sleeve (sold separately).</p>	
AC5170	<p>Coaxial I/A Tip, 90 degrees</p> <p>Coaxial I/A tip with straight shaft and 90-degree curved tip. 0.3mm dual sideport aspiration and 16g irrigation sleeve.</p>	
AC5170T	<p>Coaxial I/A Tip, 90 degrees</p> <p>Titanium, coaxial I/A tip with straight shaft and 90-degree curved tip. 0.3mm dual sideport aspiration and 16g irrigation sleeve.</p>	
AC5180	<p>Coaxial I/A Tip, 150 degrees</p> <p>Coaxial I/A tip with straight shaft and 150-degree curved tip. 0.3mm dual sideport aspiration and 16g irrigation sleeve.</p>	
AC5180T	<p>Coaxial I/A Tip, 150 degrees</p> <p>Titanium, coaxial I/A tip with straight shaft and 150-degree curved tip. 0.3mm dual sideport aspiration and 16g irrigation sleeve.</p>	

Knife Handles

BARD-PARKER KNIFE HANDLES

Item #	Description	Image
Bard-Parker Knife Handle		
Knife handle compatible with 10, 11, 12, and 15 style blades. Flat handle.		
AH2505	Bard-Parker Knife, #3 Handle Ruler markings. Overall length: 124mm.	
AH2506	Bard-Parker Knife, #7 Handle Overall length: 165mm.	
AH2510	Bard-Parker Knife, #9 Handle Overall length: 116mm.	



BEAVER CHUCK KNIFE HANDLES

Item #	Description	Image
Beaver Chuck Knife Handle		
Collet tip, compatible with 50, 60, and 70 series blades. Round handle. Overall length: 102mm.		
AH2515	Beaver Chuck Knife, #3 Handle	

Reusable Knives







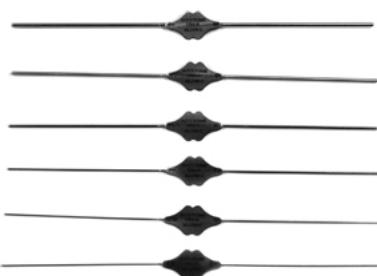

REUSABLE KNIVES

Item #	Description	Image
Gill Corneal Knife		
Straight shaft, 3mm x 18mm smooth blade. Flat handle. Overall length: 119mm.		
AH2540	Gill Corneal Knife	
Martinez Double-Ended Corneal Dissector Knife		
Double-ended, angled shafts, 11mm from bend to tip, 3mm wide sharp blades. Flat handle. Overall length: 127mm.		
AH2595	Martinez Double-Ended Corneal Knife	
Tooke Corneal Knife		
Straight shaft, 3mm x 18mm smooth blade. Flat handle. Overall length: 119mm.		
AH2580	Tooke Corneal Knife	

Lacrimal Instruments

LACRIMAL PROBES

Item #	Description	Image
Bowman Lacrimal Probe Set		
Set of six stainless steel probes. Double-ended. Overall length: 149mm.		
AL1375	Bowman Lacrimal Probe Set	
Bowman Lacrimal Probe		
Variety of sizes. Sterling silver. Overall length: 149mm.		
AL1330	Bowman Lacrimal Probe Sizes 0000 and 000 Sizes: 0000 and 000.	
AL1320	Bowman Lacrimal Probe Sizes 00 and 0 Sizes: 00 and 0.	
AL1340	Bowman Lacrimal Probe Sizes 1 and 2 Sizes: 1 and 2.	
AL1350	Bowman Lacrimal Probe Sizes 3 and 4 Sizes: 3 and 4.	
AL1360	Bowman Lacrimal Probe Sizes 5 and 6 Sizes: 5 and 6.	

LACRIMAL PROBES

Item #	Description	Image
ALI370	Bowman Lacrimal Probe Sizes 7 and 8 Sizes: 7 and 8.	

Catalano Intubation Probe Set

Set of two, 0.7mm diameter probes attached to 30.5cm long silicone tubing, 0.012" I.D., 0.025" O.D.

ALI530	Catalano Intubation Set	
--------	--------------------------------	--

Pigtail Probe

Stainless steel, double-ended, straight shafts with pigtail curved probes on both ends, 8mm blunt probe tips with suture eye holes. Round handle. Overall length: 143mm.

ALI420	Pigtail Probe	
--------	----------------------	---

Jackson Lacrimal Intubation Set



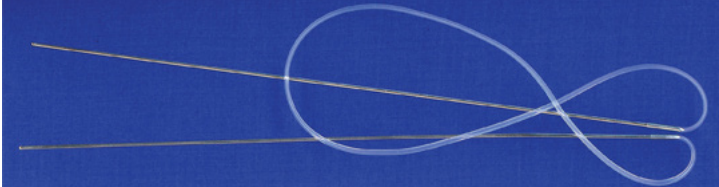

2 blunt 0.9mm diameter probes, attached to 30.5cm long silicone tubing, 0.012" I.D., 0.025" O.D.

ALI400	Jackson Lacrimal Intubation Set	
--------	--	--

LACRIMAL DILATORS



Item #	Description	Image
	Castroviejo Double-Ended Lacrimal Dilator	
	One needle-point end and one medium-taper end, round, knurled handle. Overall length: 140mm.	
ALI380	Castroviejo Lacrimal Dilator	

LACRIMAL DILATORS

Item #	Description	Image
Hosford Double-Ended Lacrimal Dilator		
2.0mm tapered end, gradually tapered other end, rounded handle. Overall length 140mm.		
AL1390	Hosford Double-Ended Lacrimal Dilator	
Infant Lacrimal Dilator		
Very fine, blunt tip. Round handle. Overall length: 79mm.		
AL1280	Infant Lacrimal Dilator	
Muldoon Lacrimal Dilator		
Medium 27mm taper, distal end is straight to act as a guide for the tapered dilator that follows. Round, knurled handle. Overall length: 98mm.		
AL1410	Muldoon Lacrimal Dilator	
Ruedemann Lacrimal Dilator		
Short 12mm taper, needle type. Round handle. Overall length: 73mm.		
AL1430	Ruedemann Lacrimal Dilator	
Wilder Lacrimal Dilator		
Long, medium, and short taper, blunt tip, round handle. Overall length: 98mm.		
AL1440	Wilder Lacrimal Dilator, Long Long 32mm taper.	
AL1450	Wilder Lacrimal Dilator, Medium Medium 23mm taper.	
AL1460	Wilder Lacrimal Dilator, Short Short 19mm taper.	



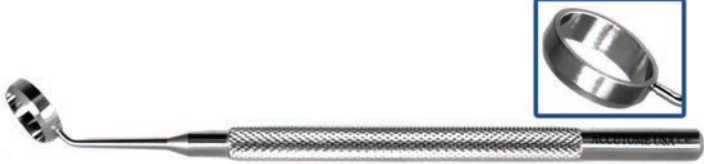



LASEK Instruments

LASEK INSTRUMENTS

Item #	Description	Image
Camellin LASEK Trephine		
Doubled-ended. Flat handle. Overall length: 114mm.		
AR0580	8mm Camellin LASEK Trephine 8mm LASEK trephine with 8.5mm alcohol well.	
AR0585	9mm Camellin LASEK Trephine 9mm LASEK trephine with 9.5mm alcohol well	
LASEK Alcohol Well		
7.5mm to 9.5mm diameter. Round handle.		
AR0603	7.5mm LASEK Alcohol Well 7.5mm diameter.	
AR0600	8.5mm LASEK Alcohol Well 8.5mm diameter	
AR0602	9.0mm LASEK Alcohol Well 9.0mm diameter.	
AR0605	9.5mm LASEK Alcohol Well 9.5mm diameter.	
LASEK Epithelial Trephine		
8.0mm and 9.5mm diameter. Round handle.		
AR0610	8.0mm LASEK Epithelial Trephine 8.0mm diameter.	
AR0616	9.5mm LASEK Epithelial Trephine 9.5mm diameter.	

Lens Loops

LENS LOOPS

Item #	Description	Image
Gills-Welsh Lens Loop		
Slightly curved loop tip, ultra thin and smooth loop. Flat handle.		
AH3110	Gills-Welsh Lens Loop Straight shaft, 6mm wide x 7mm long loop. Overall length: 135mm.	
AH3200	Double-Ended Gills-Welsh Lens Loop Double-ended. One side has a straight shaft with 5mm wide x 7mm long loop. One side has a curved shaft with olive-shaped tip. Overall length: 121mm.	
Kansas Lens Loop		
Curved shaft, 3.0mm wide-looped tip, serrated. Flat handle. Overall length: 137mm.		
AH3130	Kansas Lens Loop	
Keener-Alt Lens Loop		
Straight shaft, curved loop tip, serrated loop, 3mm wide loop. Flat handle. Overall length: 137mm.		
AH3150	Keener-Alt Lens Loop	
Kirby Intra-Capsular Lens Loop		
Straight shaft, 5mm x 10mm, curved, smooth loop tip. Round handle. Overall length: 138mm.		
AH3170	Kirby Intra-Capsular Lens Loop	 

LENS LOOPS

Item #	Description	Image
--------	-------------	-------

Lewis Lens Loop

Straight shaft, curved tear-drop-shaped loop. Flat handle. Overall length: 134mm.

AH3180	Lewis Lens Loop, Large Large 5mm x 7mm loop.	 
AH3190	Lewis Lens Loop, Small Small 4mm x 6mm loop.	

**New Orleans Eye and Ear Lens Loop**

Straight shaft, curved loop tip, 5mm wide x 10mm long smooth oval loop. Flat handle. Overall length: 142mm.

AH3210	New Orleans Eye and Ear Lens Loop
--------	--

**Simcoe Double-Ended Nucleus Loop**

Double-ended, both ends angled loops, 4mm wide x 20mm long loops, serrations on tops of loops. Round handle. Overall length: 140mm.

AH3220	Simcoe Double-Ended Nucleus Loop
--------	---

**Wilder Lens Loop**

Straight shaft, curved tip, long tear-drop-shaped loop, serrated 4mm x 14mm loop. Flat handle. Overall length: 136mm.

AH3230	Wilder Lens Loop
--------	-------------------------



















Needle Holders

LOCKING NEEDLE HOLDERS

Item #	Description	Image
Anis Needle Holder, Locking		
Stainless steel Anis Needle Holders with locking mechanisms come with either a straight or curved extra delicate 8mm jaw pattern. Overall length: 127mm.		
AN0120	Anis Needle Holder, Curved Curved shaft.	
AN0140	Anis Needle Holder, Straight Straight shaft.	
Barraquer Needle Holder, Locking		
Straight and curved jaws, with various jaw sizes and styles. Comes with a locking mechanism.		
AN0210	Barraquer Needle Holder, Straight Straight, 9mm delicate jaws with lock. Overall length: 130mm.	 
AN0210T1	Barraquer Needle Holder, Straight Titanium. Straight, 9mm delicate jaws with lock. Overall length: 130mm.	 
AN0150	Barraquer Needle Holder, Curved Curved, 9mm delicate jaws with lock. Overall length: 130mm.	 
AN0510	Barraquer Needle Holder, Curved Curved, 9mm medium jaws with lock. Overall length: 130mm.	 
AN0150T1	Barraquer Needle Holder, Curved Titanium, curved, 9mm delicate jaws with lock. Overall length: 133mm.	 
AN0160	Barraquer Needle Holder, Curved Curved, 9mm standard jaws with lock. Overall length: 130mm.	 

LOCKING NEEDLE HOLDERS

Item #	Description	Image
AN0160TI	Barraquer Needle Holder, Curved Titanium, curved, 9mm medium jaws with lock. Overall length: 130mm.	 
AN0170T	Barraquer Needle Holder, Curved Titanium, curved, 10mm fine jaws with lock. Overall length: 136mm.	 
Castroviejo Needle Holder, Locking		
Straight and curved jaws, with various jaw sizes and styles. Comes with a locking mechanism.		
AN0310	Castroviejo Needle Holder, Straight Straight, 9mm fine jaws with lock. Overall length: 139mm.	 
AN0270	Castroviejo Needle Holder, Straight Straight, 9mm medium jaws with lock. Overall length: 140mm.	 
AN0300	Castroviejo Needle Holder, Straight Straight, 10mm medium jaws with lock. Overall length: 136mm.	 
AN0300TI	Castroviejo Needle Holder, Straight Titanium. Straight, 10mm medium jaws with lock. Overall length: 136mm.	 
AN0290	Castroviejo Needle Holder, Straight Straight, 12mm heavy jaws with lock. Overall length: 136mm.	 
AN0280	Castroviejo Needle Holder, Straight Straight, 16mm heavy jaws with lock. Overall length: 149mm.	 

LOCKING NEEDLE HOLDERS

Item #	Description	Image
AN0230	Castroviejo Needle Holder, Curved Curved, 9mm fine jaws with lock. Overall length: 139mm.	 A pair of curved needle holders with fine, serrated jaws. The handle is silver with a locking mechanism. An inset image shows a close-up of the jaws.
AN0240	Castroviejo Needle Holder, Curved Curved, 11mm medium jaws with lock. Overall Length: 135mm.	 A pair of curved needle holders with medium, serrated jaws. The handle is silver with a locking mechanism. An inset image shows a close-up of the jaws. The handle is marked with 'AN0240'.
AN0240TI	Castroviejo Needle Holder, Curved Titanium, curved, 11mm medium jaws with lock. Overall length: 136mm.	 A pair of curved needle holders with medium, serrated jaws. The handle is blue with a locking mechanism. An inset image shows a close-up of the jaws. The handle is marked with 'AN0240TI' and 'CE'.
AN0250	Castroviejo Needle Holder, Curved Curved, 12mm standard jaws with lock. Overall length: 136mm.	 A pair of curved needle holders with standard, serrated jaws. The handle is silver with a locking mechanism. An inset image shows a close-up of the jaws. The handle is marked with 'ACUTOME AN0250'.

Jaffe Needle Holder

Straight, delicate jaws with lock. Flat, 3-hole handle.







AN0400	Jaffe Needle Holder	 A pair of straight needle holders with delicate, serrated jaws. The handle is silver with a locking mechanism and three circular holes. An inset image shows a close-up of the jaws. The handle is marked with 'AN0400' and 'CE'.
--------	----------------------------	--

Kalt Needle Holder

Kalt Needle Holders with straight jaws. Available in standard, medium, or heavy jaws with or without serration. Flat, cross-action handle. Overall length: 143mm.

AN0410	Heavy Needle Holder Straight, heavy 12mm serrated jaws with lock.	 A pair of straight needle holders with heavy, serrated jaws. The handle is silver with a locking mechanism. The handle is marked with 'ACUTOME'.
AN0430	Medium Needle Holder Straight, medium 10mm finely serrated jaws with lock.	
AN0440	Standard Needle Holder Straight, standard 10mm jaws with lock.	

LOCKING NEEDLE HOLDERS

Item #	Description	Image
McPherson Needle Holder		
McPherson Needle Holders are available in both straight and curved, very delicate 11mm jaw options. Comes with locking mechanism. Flat, cross-action handle. Overall length: 107mm.		
AN0460	Needle Holder, Curved Strongly curved jaws.	
AN0480	Needle Holder, Straight Straight jaws.	
Needle Holder, Locking		
Various stainless steel or titanium needle holders with curved or straight shafts. Different jaw sizes and styles are available. Comes with locking mechanism.		
AN0500	Needle Holder, Curved Curved, 6mm extra delicate jaws with lock. Overall length: 120mm.	
AN0620	Needle Holder, Curved Titanium, curved, 9mm delicate jaws with lock. Overall length: 130mm.	
AN0540	Needle Holder, Straight Straight, 6mm extra delicate jaws with lock. Overall length: 120mm.	
Troutman Needle Holder		
Gently curved, medium 9mm smooth jaws with lock. Round handle with longitudinal serrations. Overall length: 120mm.		
AN0600	Troutman Needle Holder	

NON-LOCKING NEEDLE HOLDERS



Item #	Description	Image
Anis Needle Holder, Non-Locking		
Anis Needle Holders without locks come with either straight or curved 8mm delicate jaws. Various jaw styles are available. Overall length: 127mm.		
AN0110	Anis Needle Holder, Curved Curved jaws.	A pair of stainless steel curved needle holders with 8mm delicate jaws. The handles have a textured grip. A small inset image shows a close-up of the curved jaws. The main image shows the full instrument with 'ACCUTOME USA CH AN0110 C' engraved on the handle.
AN0110TI	Anis Needle Holder, Curved Titanium. Curved jaws.	A pair of blue titanium curved needle holders with 8mm delicate jaws. The handles have a textured grip. A small inset image shows a close-up of the curved jaws. The main image shows the full instrument with 'ACCUTOME USA CH AN0110 C' engraved on the handle.
AN0130	Anis Needle Holder, Straight Straight jaws.	A pair of stainless steel straight needle holders with 8mm delicate jaws. The handles have a textured grip. A small inset image shows a close-up of the straight jaws. The main image shows the full instrument.
Barraquer Needle Holder, Non-Locking		
Straight and curved jaws, with various jaw sizes and styles. No locking mechanisms.		
AN0220	Barraquer Needle Holder, Straight Straight, 9mm jaws. Overall length: 133mm.	A pair of stainless steel straight Barraquer needle holders with 9mm jaws. The handles have a textured grip. A small inset image shows a close-up of the straight jaws. The main image shows the full instrument with 'AN0220' engraved on the handle.
AN0180	Barraquer Needle Holder, Curved Curved, 9mm jaws. Overall length: 130mm.	A pair of stainless steel curved Barraquer needle holders with 9mm jaws. The handles have a textured grip. A small inset image shows a close-up of the curved jaws. The main image shows the full instrument with 'AN0180' engraved on the handle.
AN0180TI	Barraquer Needle Holder, Curved Titanium. Curved, 9mm jaws. Overall length: 130mm.	A pair of blue titanium curved Barraquer needle holders with 9mm jaws. The handles have a textured grip. A small inset image shows a close-up of the curved jaws. The main image shows the full instrument.
AN0190	Barraquer Needle Holder, Curved Curved, 9mm jaws. Overall length: 130mm.	A pair of stainless steel curved Barraquer needle holders with 9mm jaws. The handles have a textured grip. A small inset image shows a close-up of the curved jaws. The main image shows the full instrument with 'ACCUTOME USA CH AN0190 C' engraved on the handle.

NON-LOCKING NEEDLE HOLDERS

Item #	Description	Image
AN0200	Barraquer Needle Holder, Curved Curved, 10mm jaws. Overall length: 130mm.	
AN0200TI	Barraquer Needle Holder, Curved Titanium. Curved, 10mm jaws. Overall length: 136mm.	
AN0170	Barraquer Needle Holder, Curved Curved, 11mm jaws. Overall length: 130mm.	
AN0145	Barraquer Needle Holder, Curved Curved, 9mm jaws. Overall length: 95mm.	

Castroviejo Needle Holder, Non-Locking

Straight and curved medium 10mm jaws. No locking mechanism. Overall length: 136mm.

AN0260	Castroviejo Needle Holder, Curved Curved jaws.	
AN0320	Castroviejo Needle Holder, Straight Straight jaws.	

Cohan Needle Holder



Titanium, curved, 7.5mm fine jaws. No locking mechanism. Overall length: 104mm

AN0350TI	Cohan Needle Holder	
----------	----------------------------	--

NON-LOCKING NEEDLE HOLDERS

Item #	Description	Image
McPherson Needle Holder		
McPherson Needle Holders are available in both straight and curved 11mm jaw options. No locking mechanism. Flat, squeeze handle. Overall length: 107mm.		
AN0470	Needle Holder, Curved Strongly curved, very delicate 11mm jaws.	
AN0490	Needle Holder, Straight Straight, very delicate 11mm jaws.	
Needle Holder, Non-Locking		
Various stainless steel or titanium needle holders with curved or straight shafts. Different jaw sizes and styles are available. No locking mechanism. Flat, squeeze handle.		
AN0560	Needle Holder, Straight Straight, 6mm extra delicate jaws. Overall length: 120mm.	
AN0520	Needle Holder, Curved Curved, 9mm extra delicate jaws. Overall length: 120mm.	
AN0625	Needle Holder, Curved Titanium, curved, 9mm medium jaws. Overall length: 109mm.	
O'Gawa Needle Holder		
Curved, 8mm delicate jaws. No locking mechanism. Flat, squeeze handle. Overall length: 130mm.		
AN0525	O'Gawa Needle Holder	

NON-LOCKING NEEDLE HOLDERS

Item #	Description	Image
Osher Needle Holder		
Curved, 9mm delicate jaws. No locking mechanism. Flat, squeeze handle. Overall length: 110mm.		
AN0700	Osher Needle Holder	 <p>The image shows an Osher Needle Holder (AN0700). It features curved, 9mm delicate jaws. The handle is flat with a textured, serrated grip. The overall length is 110mm. An inset image provides a magnified view of the jaws. The model number 'AN0700' is visible on the handle.</p>
Troutman Needle Holder		
Gently curved, medium 9mm smooth jaws. No locking mechanism. Round, squeeze handle with longitudinal serrations. Overall length: 120mm.		
AN0610	Troutman Needle Holder	 <p>The image shows a Troutman Needle Holder (AN0610). It features gently curved, medium 9mm smooth jaws. The handle is round with longitudinal serrations. The overall length is 120mm. The model number 'AN0610' is visible on the handle.</p>

Office Instruments

OPHTHALMIC BURRS

Item #	Description	Image
--------	-------------	-------

Aaron Burr 2

The Bovie Aaron Burr 2 is ideal for neurological procedures. Aaron Burr 2 includes one disposable 1mm burr tip (AXI3070) for corneal rust ring removal. An AA alkaline battery is included, and it also comes with a foam-lined case.

AXI3929 **Aaron Burr 2**

**Aaron Burr 2 Accessories**

The Bovie Aaron Burr 2 is ideal for neurological procedures. Aaron Burr 2 has various burr accessories that range in tip size.

AXI4029 **0.5mm Burr Tip**
0.5mm disposable burr tip for use with Bovie AB03, AB04, or equivalent. Sold 10 per box. Overall length: 43mm.

AXI3070 **1mm Burr Tip**
1.0mm disposable burr tip for use with Aaron Burr 2 (AXI3929) or equivalent. For corneal rust ring removal. Sold 10 per box. Overall length: 39mm.

AXI4533 **2.5mm Burr Tip**
2.5mm reusable burr tip for use with Aaron Burr 2 (AXI3929) or equivalent. Sold 1 per box. Overall length: 105mm.

AXI3930 **5mm Burr Tip**
5mm reusable diamond burr tip for use with Aaron Burr 2 (AXI3929) or equivalent. Sold 1 per box. Overall length: 127mm.

**Algerbrush II**

The Algerbrush II has a very low torque motor powered by a single AA battery. The burr in this rotary instrument is used as a "brush" rather than as a drill and the rust ring is thus "brushed" from the cornea or sclera leaving a smooth surface, which heals much faster than with other instruments used for this purpose. Algerbrush II foreign body rust ring remover. Single speed, motorized, AA battery operated handpiece. Comes with tip cover, chuck, and 0.5mm burr. Overall Length: 105mm.

AM0100 **Algerbrush II Corneal Rust Remover**

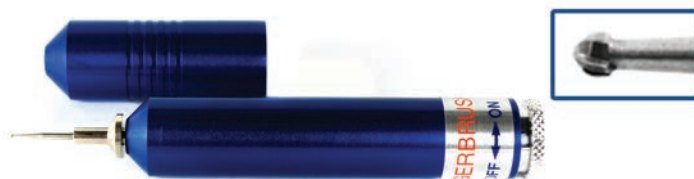
**Algerbrush II Accessories**

Accessories for the Algerbrush II foreign body rust ring remover. This includes various types and sizes of burrs as well as chucks.

AM0105 **Algerbrush Chuck**
Algerbrush II replacement chuck.

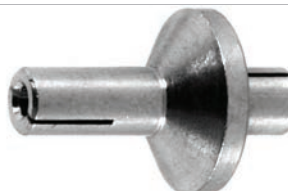





OPHTHALMIC BURRS

Item #	Description	Image
AM0110	<p>Algerbrush 0.5mm Burr</p> <p>Algerbrush II 0.5mm replacement burr, burr only. Overall length: 22mm.</p>	
AM0120	<p>Algerbrush 1.0mm Burr</p> <p>Algerbrush II 1.0mm replacement burr, burr only. Overall length: 22mm.</p>	
AM0125	<p>Algerbrush 2.5mm Ball</p> <p>Algerbrush II 2.5mm replacement round, fine grit, diamond ball, tip only. Overall length: 30mm.</p>	
AM0126	<p>Algerbrush 3.5mm Ball</p> <p>Algerbrush II 3.5mm replacement round, medium grit, diamond ball, tip only. Overall length: 22mm.</p>	
AM0128	<p>Algerbrush 4.0mm Wheel</p> <p>Algerbrush II 4.0mm replacement fine grit, diamond wheel, tip only. Overall length: 44mm.</p>	
AM0127	<p>Algerbrush 5.0mm Wheel</p> <p>Algerbrush II 5.0mm replacement medium grit, diamond wheel, tip only. Overall length: 44mm.</p>	

FOREIGN BODY INSTRUMENTS

Item #	Description	Image
<p>Ellis Foreign Body Spud</p> <p>Straight shaft, curved tip, 1mm rounded blade. Flat handle. Overall length: 117mm.</p>		
AH6500	<p>Ellis Foreign Body Spud</p>	

FOREIGN BODY INSTRUMENTS

Item #	Description	Image
Foreign Body Curette		
Straight shaft, 3mm shaft, 1mm cup tip. Flat handle. Overall length: 127mm.		
AH0260	Foreign Body Curette	 <p>The image shows a Foreign Body Curette (AH0260) with a long, thin shaft and a small cup-shaped tip. A magnified inset shows the cup tip. The handle is flat and has 'ACCUTOME' and 'AH0260' printed on it.</p>
Foreign Body Spud		
Straight shaft, lance-shaped tip, gently curved, 2mm tip. Flat handle. Overall length: 120mm.		
AH6510	Foreign Body Spud	 <p>The image shows a Foreign Body Spud (AH6510) with a long, thin shaft and a lance-shaped tip. A magnified inset shows the tip. The handle is flat and has 'ACCUTOME AH6510' printed on it.</p>
Francis Spud		
Straight shaft, flag-shaped tip with sharp edge. Flat handle. Overall length: 120mm.		
AH6520	Francis Spud	 <p>The image shows a Francis Spud (AH6520) with a long, thin shaft and a flag-shaped tip with a sharp edge. A magnified inset shows the tip. The handle is flat and has 'ACCUTOME AH6520' printed on it.</p>
Golf Club Spud		
Straight shaft, golf-club-shaped with sharp edge. Flat serrated handle. Overall length: 119mm.		
AH6530	Golf Club Spud	 <p>The image shows a Golf Club Spud (AH6530) with a long, thin shaft and a golf-club-shaped tip with a sharp edge. The handle is flat and serrated, with 'ACCUTOME AH6530' printed on it.</p>

SCLERAL DEPRESSORS

Item #	Description	Image
--------	-------------	-------

Flynn Scleral Depressor

Pediatric size. Straight shaft, lens loop style tip. Flat serrated handle. Overall length: 80mm.

AH0300	Flynn Scleral Depressor	
--------	---	--



Schepens Scleral Depressor

Large, medium, and small Schepens Scleral Depressors are thimble shaped with 8mm wide depressor tips. Stainless steel with dull finish. Overall length: 43mm.

AL1120	Small Scleral Depressor Size 8 small thimble.	
--------	--	--

AL1100	Medium Scleral Depressor Size 10 medium thimble.	
--------	---	--

AL1110	Large Scleral Depressor Size 12 large thimble.	
--------	---	--



Schocket Double-Ended Scleral Depressor

Stainless steel. Slightly angled shafts, 16mm from bend to tip. T-shaped hammerhead tip on one side and ball-shaped tip on the other. Flat handle, comes with pocket clip. Overall length: 137mm.

AL1130	Schocket Double-Ended Scleral Depressor	
--------	---	--



Punches



The image features a dark blue background with a subtle grid pattern of light blue lines. A prominent horizontal bar with a blue-to-white gradient spans the width of the page, positioned below the title. The title 'Punches' is rendered in a clean, white, sans-serif font.

PUNCHES

Item #	Description	Image
Kelly Descemet's Membrane Punch		
Stainless steel Kelly Descemet's Membrane Punch produces round punches without tissue tags. Punches have serrated squeeze action handles. Overall length: 130mm.		
AM0410	0.75mm Membrane Punch Produces an exact 0.75mm round hole.	
AM0410 1.00	1.0mm Membrane Punch Produces an exact 1.0mm round hole.	

Retinal Picks

RETINAL PICKS

Item #	Description	Image
Olk Angled Retinal Pick		
Straight shaft, 0.5mm angled tip, squared. Round handle. Overall length: 125mm.		
AH5290	110-Degree Retinal Pick 110-degree tip angle.	
AH5310	150-Degree Retinal Pick 150-degree tip angle.	

Scissors

The image features a dark blue background with a subtle, repeating pattern of light blue geometric shapes, possibly stylized letters or symbols. A prominent horizontal bar with a blue-to-white gradient spans the width of the page, positioned below the main title. The title 'Scissors' is rendered in a clean, white, sans-serif font.

CORNEAL SCISSORS

Item # Description Image

Aebli Corneal Scissors

Angled and straight blades and universal standard pattern with blunt tips.

AS0120 Aebli Corneal Scissors, Straight Straight 19mm blades. Ring handle. Overall length: 92mm.



AS0110 Aebli Corneal Scissors, Straight Straight 21mm blades. Ribbon handle. Overall length: 99mm.



AS0100 Aebli Corneal Scissors, Angled Angled 21mm blades. Ribbon handle. Overall length: 99mm.





Aebli Corneal Section Scissors

Angled left and right 18mm blades, blunt tips. Flat, squeeze handle. Overall length: 120mm.

AS0310 Aebli Corneal Scissors, Angled Right Angled right blades.



CORNEAL SCISSORS

Item #	Description	Image
AS0320	Aebli Corneal Scissors, Angled Left Angled left blades.	 

Manson-Aebli Corneal Scissors

Angled left and right 19mm blades, lower blade 1.5mm longer than upper blade, blunt tips. Flat squeeze handle. Overall length: 120mm.

AS1115	Corneal Scissors, Angled Right Angled right blades.	 
AS1105	Corneal Scissors, Angled Left Angled left blades.	

Azar Corneal Scissors

Curved 16mm blades, universal medium model, blunt tips, calibration marks at 1mm to 6mm. Flat handle. Overall length: 115mm.

AS0130	Azar Corneal Scissors	
--------	------------------------------	---



Barraquer Corneal Section Scissors

Angled left and right 19 mm blades, 45-degree angle, blunt tips. Flat squeeze handle, locking handle.





AS1110	Left Section Scissors Angled left blades.	 
AS1120	Right Section Scissors Angled right blades.	

Castroviejo Corneal Scissors

Curved and angled blades with blunt tips and flat squeeze handle.

AS0150	Castroviejo Corneal Scissors, Miniature Curved 11mm blades, universal miniature model, fine tips. Overall length: 106mm.	
AS0180	Castroviejo Corneal Scissors, Miniature Curved left 11mm blades, miniature model. Overall length: 106mm.	 

CORNEAL SCISSORS





Item #	Description	Image
AS0190	Castroviejo Corneal Scissors, Miniature Curved right 11mm blades, miniature model. Overall length: 106mm.	 A pair of miniature corneal scissors with curved right blades. The handle has a textured grip and the model number AS0190 is visible.
AS0140	Castroviejo Corneal Scissors, Miniature Straight 19mm blades, universal miniature model. Overall length: 106mm.	 A pair of miniature corneal scissors with straight blades. The handle has a textured grip and the model number AS0140 is visible.
AS0200	Castroviejo Corneal Scissors, Medium Strong curved 16mm blades, universal medium model. Overall length: 115mm.	 A pair of medium-sized corneal scissors with strong curved blades. The handle has a textured grip and the model number AS0200 is visible.
AS0170	Castroviejo Corneal Scissors, Medium Medium curved 16mm blades, universal medium model. Overall length: 115mm.	 A pair of medium-sized corneal scissors with medium curved blades. The handle has a textured grip and the model number AS0170 is visible.
AS0160	Castroviejo Corneal Scissors, Medium Medium curved 16mm blades, universal medium model. 3-hole handle. Overall length: 115mm.	 A pair of medium-sized corneal scissors with medium curved blades and a 3-hole handle. The handle has a textured grip and the model number ACCUTOME AS 0160 is visible.

Castroviejo Corneal Section Scissors

Curved and angled blades with flat squeeze handle.

AS1150	Castroviejo Corneal Scissors, Left Curved left 9mm blades, lower blade 0.5mm longer than upper blade, sub-miniature model, blunt tips. Overall length: 103mm.	 A pair of sub-miniature corneal section scissors with curved left blades. The handle has a textured grip and the model number AS1150 is visible.
AS1200	Castroviejo Corneal Scissors, Right Curved right 9mm blades, lower blade 0.5mm longer than upper blade, sub-miniature model, blunt tips. Overall length: 103mm.	 A pair of sub-miniature corneal section scissors with curved right blades. The handle has a textured grip and the model number AS1200 is visible.
AS1160	Castroviejo Corneal Scissors, Left Curved left 13mm blades, lower blade 0.5mm longer than upper blade, mid-miniature model, blunt tips. Overall length: 106mm.	 A pair of mid-miniature corneal section scissors with curved left blades. The handle has a textured grip and the model number ACCUTOME CE is visible.

CORNEAL SCISSORS

Item #	Description	Image
ASI210	Castroviejo Corneal Scissors, Right Curved right 13mm blades, mid-miniature model, lower blade 0.5mm longer than upper blade, blunt tips. Overall length: 106mm.	
ASI170	Castroviejo Corneal Scissors, Left Angled left 14mm blades, blunt tips, lower blade 0.5mm longer than upper blade. Overall length: 106mm.	
ASI220	Castroviejo Corneal Scissors, Right Angled right 14mm blades, blunt tips, lower blade 0.5mm longer than upper blade. Overall length: 106mm.	
ASI140	Castroviejo Corneal Scissors, Left Angled left 18mm blades, curved to conform to the curve of the limbus, lower blade 1mm longer than upper blade, blunt tips. Overall length: 112mm.	
ASI190	Castroviejo Corneal Scissors, Right Angled right 18mm blades, curved to conform to the curve of the limbus, lower blade 1mm longer than upper blade, blunt tips. Overall length: 112mm.	

Castroviejo Keratoplasty Scissors

Angled to side 16mm blades, universal model, medium, lower blade 1mm longer than upper blade, blunt tips. Flat handle. Overall length: 110mm.



AS0210	Castroviejo Keratoplasty Scissors	
--------	--	--

Hoffer-Stern Scissors

Angled forward 10mm blades, extra thin, blunt tips. Flat, serrated handle. Overall length: 112mm.

AS5560	Hoffer-Stern Curved Scissors	
--------	-------------------------------------	--

CORNEAL SCISSORS

Item #	Description	Image
Katzin Corneal Transplant Scissors		
Curved left and right blades, lower blade 12mm, upper blade 11mm, miniature model, blunt tips. Flat 3-hole, squeeze handle. Overall length: 108mm.		
AS0220	Katzin Curved Corneal Scissors, Right Strongly curved right blades.	
AS0230	Katzin Curved Corneal Scissors, Left Strongly curved left blades.	
Troutman-Castroviejo Corneal Section Scissors		
Curved left and right 13mm blades, miniature model, blunt tips. Flat handle, locking handle.		
AS1270	Troutman-Castroviejo Scissors, Left Curved left blades. Overall length: 116mm.	
AS1290	Troutman-Castroviejo Scissors, Right Curved right blades. Overall length: 105mm.	
Troutman-Katzin Corneal Transplant Scissors		
Strongly curved left blades, small, blunt tips. Flat, 3-hole, locking handle. Overall length: 105mm.		
AS0290	Troutman-Katzin Corneal Scissors	



ENUCLEATION SCISSORS

Item #	Description	Image
Enucleation Scissors		
Curved blades, heavy, blunt, rounded tips. Ring handle. Overall length: 131mm.		
AS2120	Enucleation Scissors, Strong Curve Strongly curved 40mm blades.	
AS2110	Enucleation Scissors, Medium Curve Medium curved 44mm blades.	



ENUCLEATION SCISSORS

Item #	Description	Image
AS2100	<p>Enucleation Scissors, Light Curve Lightly curved 44mm blades.</p>	



EYE SCISSORS

Item #	Description	Image
Eye Scissors		
Straight and curved blades, 29mm and 30mm blades.		
AS5130	<p>Eye Scissors, Curved Curved 29mm blades, blunt tips. Ribbon handle. Overall length: 107mm.</p>	
AS5120	<p>Eye Scissors, Straight Straight 29mm blades, sharp, pointed tips. Ribbon handle. Overall length: 109mm.</p>	
AS5160	<p>Eye Scissors, Straight Straight 29mm blades, round, blunt tips. Ribbon handle. Overall length: 107mm.</p>	





EYE SCISSORS

Item #	Description	Image
AS5140	<p>Eye Scissors, Curved</p> <p>Curved 30mm blades, sharp tips. Ring handle. Overall length: 109mm.</p>	
AS5170	<p>Eye Scissors, Straight</p> <p>Straight 30mm blades, sharp tips. Ring handle. Overall length: 109mm.</p>	

INTRAOCULAR SCISSORS

Item #	Description	Image
Intraocular Scissors		
Microscissors with straight tubular shafts available with straight or curved 2mm blades. All scissors have titanium, squeeze-action handles.		
AS2310	<p>Intraocular Scissors, Curved</p> <p>Curved blades. Overall length: 146mm.</p>	
AS2320	<p>Intraocular Scissors, Angled</p> <p>Angled blades. Overall length: 146mm.</p>	
AS2390	<p>Intraocular Scissors, Straight</p> <p>Straight blades. Overall length: 146mm.</p>	



INTRAOCULAR SCISSORS

Item #	Description	Image
AS0940	<p>Intraocular Scissors, Angled</p> <p>23g shaft, angled 45 degree blades. For cutting parallel to the retina. Overall length: 134mm.</p>	 
AS0900	<p>Intraocular Scissors, Straight</p> <p>23g shaft, straight blades. Overall length: 142mm.</p>	 







IOL REMOVAL SCISSORS

Item #	Description	Image
Accutome IOL Cutter		
Accutome cutter for the explanting, or removal, of an IOL. Angled left 7mm blades, rounded, blunt tips. Flat handle. Overall length: 92mm.		
AS0301	Accutome IOL Cutter	











IRIS SCISSORS

Item #	Description	Image
Barraquer Iris Scissors		
Angled 7.5mm blades, delicate, blunt tips. Flat, squeeze-action handle. Overall length: 54mm.		
AS3100	Barraquer Iris Scissors	
Cohan-Vannas Curved Iris Scissors		
Straight 12mm blades, sharp, pointed tips. Flat, squeeze handle. Overall length: 57mm.		
AS3110	Cohan-Vannas Curved Iris Scissors	 

IRIS SCISSORS

Item #	Description	Image
DeWecker Iris Scissors		
Angled 12mm blades. Flat, squeeze handle. Overall length: 114mm.		
AS3120	Blunt Iris Scissors Blunt tip blades.	 A pair of blunt tip iris scissors with a flat, squeeze handle. The blades are angled and have blunt tips. An inset image shows a close-up of the blunt tips.
AS3130	Sharp Iris Scissors Sharp and blunt tip blades.	 A pair of sharp tip iris scissors with a flat, squeeze handle. The blades are angled and have one sharp and one blunt tip. An inset image shows a close-up of the mixed tips.
Iris Scissors		
Straight and curved blades with sharp, pointed tips.		
AS3185	Iris Scissors, Straight Straight 10mm blades. Flat, 3-hole, squeeze handle. Overall length: 108mm.	 A pair of straight iris scissors with a flat, 3-hole squeeze handle. The blades are straight and have sharp, pointed tips.
AS3190	Iris Scissors, Straight Straight 18mm blades. Ribbon handle. Overall length: 99mm.	 A pair of straight iris scissors with a ribbon handle. The blades are straight and have sharp, pointed tips. An inset image shows a close-up of the sharp tips.
AS3160	Iris Scissors, Curved Curved 18mm blades. Ribbon handle. Overall length: 99mm.	 A pair of curved iris scissors with a ribbon handle. The blades are curved and have sharp, pointed tips. An inset image shows a close-up of the sharp tips.
AS4110	Iris Scissors, Curved Curved 21mm blades. Flat, squeeze handle. Overall length: 121mm.	 A pair of curved iris scissors with a flat, squeeze handle. The blades are curved and have sharp, pointed tips. An inset image shows a close-up of the sharp tips. The handle has the text "ACCUHOME USA CH".
AS4100	Iris Scissors, Straight Straight 21mm blades. Flat, squeeze handle. Overall length: 121mm.	 A pair of straight iris scissors with a flat, squeeze handle. The blades are straight and have sharp, pointed tips. The handle has the text "AS4100" and "ACCUHOME USA CH".

IRIS SCISSORS

Item #	Description	Image
AS5180	Iris Scissors, Straight Straight 25mm blades, light standard pattern. Ring handle. Overall length: 98mm.	 
AS5150	Iris Scissors, Curved Curved 25mm blades, light standard pattern. Ring handle. Overall length: 98mm.	
AS3140	Iris Scissors, Curved Curved 25mm blades. Large ring handle. Overall length: 102mm.	
AS3170	Iris Scissors, Straight Straight 28mm blades. Large ring handle. Overall length: 100mm.	 
AS3210	Iris Scissors, Straight Straight 29mm blades. Ribbon handle. Overall length: 105mm.	 
AS3220	Iris Scissors, Curved Curved 29mm blades. Ribbon handle. Overall length: 105mm.	
AS5110	Iris Scissors, Curved Curved 30mm blades. Ring handle. Overall length: 108mm.	

McPherson-Vannas Iris Scissors

Curved 11mm blades, delicate, sharp tips. Flat, squeeze handle. Overall length: 83mm.

AS3200	McPherson-Vannas Iris Scissors	 
--------	---------------------------------------	---

MISCELLANEOUS SCISSORS

Item #	Description	Image
--------	-------------	-------

Mayo Dissecting Scissors

Straight 58mm blades, beveled, blunt tips. Ring handle. Overall length: 171mm.

AS5235	Mayo Dissecting Scissors	
--------	--	--

**Troutman Conjunctival Scissors**

Curved 17mm blades, blunt tips. Flat, locking handle. Overall length: 107mm.

AS5910	Troutman Conjunctival Scissors	
--------	--	--

**Westcott Conjunctival Scissors**

Lightly curved 16mm blades, blunt tips. Flat, wide, squeeze handle. Overall length: 132mm.

AS4580	Westcott Conjunctival Scissors	
--------	--	--



STITCH SCISSORS

Item #	Description	Image
--------	-------------	-------

Castroviejo Mini Keratoplasty-Utility-Stitch Scissors

Curved 13mm blades, miniature model, small, sharp, pointed tips. Flat handle, wide. Overall length: 131mm.

AS5100	Castroviejo Mini Keratoplasty Scissors	
--------	--	--



STITCH SCISSORS

Item #	Description	Image
--------	-------------	-------

Fine Stitch Scissors

Straight 17mm blades, delicate, sharp, pointed tips. Flat handle. Overall length: 112mm.

AS4120	Fine Stitch Scissors	
--------	--------------------------------------	--

**Jaffe Stitch Scissors**

Curved blades, medium, sharp tips. Flat, 3-hole handle. Overall length: 108mm.

AS4140	Jaffe Stitch Scissors	
--------	---------------------------------------	--

**McPherson-Westcott Stitch Scissors**

Curved, small blades, sharp, pointed tips. Flat, 3-hole handle. Overall length: 105mm.

AS4150	McPherson-Westcott Stitch Scissors	
--------	--	--



**Stitch Scissors**

Slightly curved 13mm blades, sharp, pointed tips. Ribbon handle. Overall length: 102mm.



AS4160	Stitch Scissors	
--------	---------------------------------	--



STITCH SCISSORS

Item #	Description	Image
Westcott Type Stitch Scissors		
Curved blades with sharp, pointed tips. Flat, serrated squeeze handle.		
AS4190	Curved Stitch Scissors Curved 21mm blades. Overall length: 116mm.	
AS4200	Lightly Curved Stitch Scissors Lightly curved 22mm blades. Overall length: 140mm.	

STRABISMUS SCISSORS

Item #	Description	Image
Knapp Strabismus Scissors		
Straight and curved blades, 25mm blades, rounded, blunt tips. Ring handle. Overall length: 118mm.		
AS3500	Knapp Strabismus Scissors, Curved Lightly curved blades.	
AS3510	Knapp Strabismus Scissors, Curved Strongly curved blades.	

STRABISMUS SCISSORS

Item #	Description	Image
--------	-------------	-------

AS3520 **Knapp Strabismus Scissors, Straight**
Straight blades.



Strabismus Scissors

Curved and straight blades, rounded, blunt tips. Ribbon handle. Overall length: 109mm.

AS3550 **Strabismus Scissors, Straight**
Straight 29mm blades.



AS3530 **Strabismus Scissors, Curved**
Curved 29mm blades.



AS3540 **Strabismus Scissors, Curved**
Strongly curved 27mm blades.



SUTURE SCISSORS

Item #	Description	Image
--------	-------------	-------



Littler Suture/Dissecting Scissors

Curved 27mm blades, holes in blades, round blunt tips. Ring handle. Overall length: 121mm.



AS5900 **Littler Dissecting Scissors**







SUTURE SCISSORS

Item #	Description	Image
Stitch Removal Scissors		
Straight blades with sharp tips.		
AS4170	<p data-bbox="261 432 566 457">Stitch Removal Scissors, Straight</p> <p data-bbox="261 468 773 516">Straight blades, sharp tips, delicate. Ribbon handle. Overall length: 99mm.</p>	
AS4130	<p data-bbox="261 814 566 840">Stitch Removal Scissors, Straight</p> <p data-bbox="261 850 716 898">Straight 16mm blades, sharp, pointed tips. Flat, wide, squeeze handle. Overall length: 132mm.</p>	

TENOTOMY SCISSORS

Item #	Description	Image
McPherson-Westcott Tenotomy Scissors		
Curved right 9mm blades, sub-miniature model, rounded, blunt tips. Flat, squeeze handle. Overall length: 88mm.		
AS0240	<p data-bbox="261 1270 633 1295">McPherson-Westcott Tenotomy Scissors</p>	
Shepard-Westcott Tenotomy Scissors		
Curved right 21mm blades, blunt tips, upper blade serrated. Flat, squeeze handle. Overall length: 123mm.		
AS4510	<p data-bbox="261 1575 607 1600">Shepard-Westcott Tenotomy Scissors</p>	







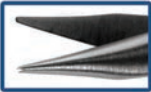

TENOTOMY SCISSORS

Item #	Description	Image
Stevens Tenotomy Scissors		
Straight and curved blades with blunt tips.		
AS4550	Stevens Tenotomy Scissors, Straight Straight 19mm blades, heavy model, blunt tips. Ring handle. Overall length: 98mm.	
AS4560	Stevens Tenotomy Scissors, Straight Straight 19mm blades, light model, blunt tips. Ribbon handle. Overall length: 98mm.	
AS4520	Stevens Tenotomy Scissors, Curved Curved 19mm blades, heavy model, blunt, round tips. Ribbon handle. Overall length: 98mm.	
AS4530	Stevens Tenotomy Scissors, Curved Curved 19mm blades, light model, blunt tips. Ribbon handle. Overall length: 98mm.	





TENOTOMY SCISSORS

Item #	Description	Image
AS4575	<p>Stevens Tenotomy Scissors, Curved</p> <p>Curved 33mm blades, blunt tips. Ring handle. Overall length: 143mm.</p>	A pair of curved tenotomy scissors with blunt tips and a ring handle. An inset image shows a close-up of the blade tips.
AS4576	<p>Stevens Tenotomy Scissors, Curved</p> <p>Curved 36mm blades, blunt tips. Ring handle. Overall length: 159mm.</p>	A pair of curved tenotomy scissors with blunt tips and a ring handle. An inset image shows a close-up of the blade tips.
AS4570	<p>Stevens Tenotomy Scissors, Straight</p> <p>Straight, standard blades 30mm from mid-screw to tips, blunt tips. Ring handle. Overall length: 112mm.</p>	A pair of straight tenotomy scissors with blunt tips and a ring handle. An inset image shows a close-up of the blade tips.
AS4540	<p>Stevens Tenotomy Scissors, Curved</p> <p>Curved, standard blades, 30mm from mid-screw to tip, blunt tips. Ring handle. Overall length: 112mm.</p>	A pair of curved tenotomy scissors with blunt tips and a ring handle. An inset image shows a close-up of the blade tips.

TENOTOMY SCISSORS

Item #	Description	Image
Westcott Tenotomy Scissors		
Curved left and right blades, blunt tips. Flat, squeeze handle.		
AS4590	Westcott Tenotomy Scissors, Curved Curved 15mm blades, medium, blunt tips. 3-hole handle. Overall length: 118mm.	 
AS4600	Westcott Tenotomy Scissors, Curved Left Curved left 19mm blades, rounded, blunt tips. Overall length: 115mm.	 
AS4610	Westcott Tenotomy Scissors, Curved Right Curved right 19mm blades, blunt tips. Overall length: 115mm.	 
AS4620	Westcott Tenotomy Scissors, Curved Right Curved right 23mm blades, round, blunt tips. Wide handle. Overall length: 143mm.	 

UTILITY SCISSORS

Item #	Description	Image
Lister Bandage Scissors		
Angled blades, probe point tip. Ring handle.		
AS6515	50mm Bandage Scissors 50mm blade from mid-screw to tip. Overall length: 119mm.	 
AS6516	67mm Bandage Scissors 67mm blade from mid-screw to tip. Overall length: 181mm.	 

UTILITY SCISSORS

Item # Description Image

Operating Scissors

Straight blades with ring handle. Overall length: 147mm.

AS5240 53mm Operating Scissors
53mm blade from mid-screw to tip, one sharp tip/blade, one blunt tip/blade.



AS6510 56mm Operating Scissors
56mm blade from mid-screw to tip, sharp tips.



Utility Scissors

25mm blades and blunt tips.

AS5190 Utility Scissors, Curved
Slightly curved 18mm blades, blunt. Ribbon handle. Overall length: 99mm.



AS5220 Utility Scissors, Curved
Curved 18mm blades, blunt tips. Ribbon handle. Overall length: 94mm.



AS5200 Utility Scissors, Curved
Curved 25mm blades, blunt tips. Ribbon handle. Overall length: 103mm.



UTILITY SCISSORS



Item #	Description	Image
AS5250	<p>Utility Scissors, Angled</p> <p>Angled 26mm blades, probe points, blunt tips. Ring handle. Overall length: 116mm.</p>	

Westcott Type Utility Scissors

Curved 25mm blades, rounded tips, sharp. Flat handle. Overall length: 131mm.

AS5210	<p>Westcott Type Utility Scissors</p>	
--------	--	--

VANNAS SCISSORS

Item #	Description	Image
Gills-Vannas Capsulotomy Scissors		
7mm blades, sharp, pointed tips. Flat, squeeze handle. Overall length: 89mm.		
AS5510	<p>Gills-Vannas Capsulotomy Scissors, Angled</p> <p>Angled forward blades. 3-hole handle.</p>	
AS5530	<p>Gills-Vannas Capsulotomy Scissors, Straight</p> <p>Straight blades.</p>	
AS5520	<p>Gills-Vannas Capsulotomy Scissors, Curved</p> <p>Curved blades.</p>	

VANNAS SCISSORS

Item # Description Image

Gills-Welsh-Vannas Micro Scissors

Angled blades, sharp, pointed tips. Flat, squeeze handle.

AS5540 5mm Gills-Welsh-Vannas Scissors
5mm blades. Overall length: 80mm.



AS5550 11mm Gills-Welsh-Vannas Scissors
11mm blades. Overall length: 86mm.



Stern-Gills Scissors

Angled forward 10mm blades, extra-thin, sharp tips. Flat, 3-hole squeeze handle. Overall length: 112mm.

AS5570 Stern-Gills Scissors



Uribe-Stern Scissors

Curved forward 10mm blades, extra-thin, sharp tips. Flat, 3-hole squeeze handle. Overall length: 112mm.

AS5580 Uribe-Stern Scissors

















Uthoff-Gills Capsulotomy Scissors

Angled 10mm blades, curved, blunt tips. Flat, squeeze handle.

AS5590 Uthoff-Gills Capsulotomy Scissors



VANNAS SCISSORS

Item #	Description	Image
Vannas Capsulotomy Scissors		
6mm blades, sharp pointed tips. Flat, squeeze handle.		
AS5610	Vannas Capsulotomy Scissors, Angled 30-degree angled blades, sharp, pointed tips. Overall length: 81mm.	 
AS5640	Vannas Capsulotomy Scissors, Curved Curved blades. Overall length: 86mm.	 
AS5680	Vannas Capsulotomy Scissors, Straight Straight blades. Overall length: 84mm.	 
AS5600	Vannas Capsulotomy Scissors, Angled Blades angled to side. Overall length: 81mm.	 
Vannas Scissors		
Curved and straight blades with extra-thin, sharp, pointed tips. Flat, 3-hole squeeze handle. Overall length: 112mm.		
AS5660	Vannas Scissors, Straight Straight 7mm blades.	 
AS5630	Vannas Scissors, Curved Curved 7mm blades.	 
AS5670	Vannas Scissors, Straight Straight 10mm blades.	 

VANNAS SCISSORS

Item #	Description	Image
AS5650	Vannas Scissors, Curved Curved 10mm blades.	

Spatulas



CYCLODIALYSIS SPATULAS

Item #	Description	Image
--------	-------------	-------

Barraquer Cyclodialysis Spatula

Angled shaft, 0.5mm x 15mm angled round blade, smooth, pointed tip, slightly curved blade. Round handle. Overall length: 120mm.

AH5100 [Barraquer Cyclodialysis Spatula](#)



Castroviejo Cyclodialysis Spatula

Double-ended and single-ended, angled shafts. Flat handle.

AH5140 [0.25mm Castroviejo Cyclodialysis Spatula](#)
 Double-ended, 0.25mm spatula, 10mm from bend to tip, 15mm from bend to tip. Overall length: 137mm.



AH5150 [0.5mm Castroviejo Cyclodialysis Spatula](#)
 Double-ended, 0.5mm flat posterior surface, 10mm from bend to tip, 15mm from bend to tip, semi-sharp tips. Overall length: 135mm.



AH5130 [0.75mm Castroviejo Cyclodialysis Spatula](#)
 0.75mm spatula, 10mm from bend to tip. Overall length: 134mm.



AH5120 [1.0mm Castroviejo Cyclodialysis Spatula](#)
 1.0mm spatula, 16mm from bend to tip. Overall length: 140mm.



Castroviejo Synechia Spatula

Double-ended, angled shafts, 0.5mm spatulas, 15mm from bend to tip, 10mm from bend to tip. Flat handle. Overall length: 133mm.

AH5160 [Castroviejo Synechia Spatula](#)





CYCLODIALYSIS SPATULAS

Item #	Description	Image
Wheeler/Elschnig Cyclo dialysis Spatula		
Double-ended, curved shaft, 1.75mm spatula, 30mm from bend to tip on both ends. Flat handle. Overall length: 140mm.		
AH5370	Wheeler Cyclo dialysis Spatula	

DSEK SPATULAS

Item #	Description	Image
Cindy Sweeper DSEK Spatula		
Angled shaft, 0.7mm spatula, 12mm from bend to tip, cylindrical smooth tip, blunt. Round handle. Overall length: 114mm.		
AH7201	Cindy Sweeper DSEK Spatula	

FEMTOSECOND SPATULAS

Item #	Description	Image
Eippert Femtosecond Spatula		
This stainless steel Eippert Femtosecond Spatula is double-ended for greater versatility and has straight shafts with 0.9mm and 2.0mm blunt thin tips to maintain proper wound architecture. Helps to ensure open incisions after femtosecond laser incisions.		
AH4605	Eippert Femtosecond Spatula, Long Long, round handle design that is ideal for use during femtosecond laser surgery. Overall length: 146mm.	
AH4606	Eippert Femtosecond Spatula, Short Short, round handle design that is ideal for use with the aberrometer. Overall length: 120mm.	

FEMTOSECOND SPATULAS

Item #	Description	Image
--------	-------------	-------

Lane Femtosecond Incisional Spatula

Double-ended Lane femtosecond cataract incisional spatula is specifically designed for opening femtosecond-created primary, secondary, and arcuate incisions in cataract surgery. One end is used to open and spread the vertical/tangential component of the femtosecond-created incision and the other end is used to open the tunnel aspect of the incision entry into the anterior chamber. Double-ended, one-angled shaft with blunt spatulated tip, 10mm from bend to tip, max depth of 0.25mm. One straight shaft with 90-degree angle, curved spatulated tip. Round handle. Overall length: 125mm.

AH6610 Lane Femtosecond Spatula



Lee Femtosecond Spatula

The Lee spatula is a femtosecond cataract instrument. Flattened tip design offers benefits of opening both sideport and main incisions. A short handle allows for easy maneuvering under modern surgical abberometers. Angled shaft. Round handle. Overall length: 115mm.

AH4620 Lee Femtosecond Spatula



Slade Femtosecond Laser Spatula

Vaulted shaft, 22.0mm from bend to tip, flattened tip for opening the main and sideport incisions. Round handle. Overall length: 115mm.

AH4600 Slade Femtosecond Spatula



Suarez Spreader

Straight shaft, angled blade tip, 1mm x 2mm blade. Round handle. Overall length: 118mm.

AH8150 Suarez Spreader



IRIS SPATULAS

Item #	Description	Image
--------	-------------	-------

Barraquer Iris Spatula

Angled shaft, 15mm from bend to tip, 0.5mm cylindrical smooth tip. Round handle. Overall length: 122mm.

AH5110	Barraquer Iris Spatula	
<p>Angled shaft, 15mm from bend to tip, 0.5mm cylindrical smooth tip. Round handle. Overall length: 122mm.</p>		



Culler Iris Spatula

Curved shaft, 1mm wide x 28mm long spatula blade. Flat handle. Overall length: 127mm.

AH5170	Culler Iris Spatula	
<p>Curved shaft, 1mm wide x 28mm long spatula blade. Flat handle. Overall length: 127mm.</p>		



Iris Spatula

Slightly curved shafts with various size malleable blade tips.

AH5220	1mm Iris Spatula	
<p>1mm wide x 30mm long tip. Flat handle. Overall length: 130mm.</p>		



AH5230	2mm Iris Spatula	
<p>2mm wide x 33mm long tip. Round handle. Overall length: 136mm.</p>		



LASIK SPATULAS

Item #	Description	Image
--------	-------------	-------

Intralase Flap Lifter and Retreatment Spatula

Double-ended, angled shaft, 1.5mm from bend to tip, slightly pointed tip, spatula tip, Z-shaped tip, 12mm wide cylindrical spatula, slightly pointed tip. Round handle. Overall length: 106mm.

AH5275	Intralase Flap Lifter and Retreatment Spatula	
<p>Double-ended, angled shaft, 1.5mm from bend to tip, slightly pointed tip, spatula tip, Z-shaped tip, 12mm wide cylindrical spatula, slightly pointed tip. Round handle. Overall length: 106mm.</p>		





LASIK SPATULAS

Item #	Description	Image
Katzen LASIK Flap "Unzipper"		
Double-ended, straight shafts, modified sinskey hook, bi-convex spatula, beveled notches. Round handle. Overall length: 133mm.		
AH1000	Katzen LASIK Flap	

PHACO SPATULAS

Item #	Description	Image
Gimbel Nucleus Spatula		
Angled 30-degree shaft, 9mm from bend to tip, 0.25mm diameter, smooth. Round handle. Overall length: 121mm.		
AH5190	Gimbel Nucleus Spatula	

Jaffe Lens Spatula		
Angled shaft, 10mm from bend to tip, 0.5mm wide, flat spatula. Flat handle. Overall length: 114mm.		
AH5240	Jaffe Lens Spatula	

Johnson Spatula		
Angled shaft, 10mm from bend to tip, 0.25mm wide blunt blade tip. Round handle. Overall length: 105mm.		
AH5500	Johnson Spatula	

Knolle Lens Nucleus Spatula and Anterior Chamber Gauge		
Curved shaft, flat spatula blade, 30mm long blade, marks at 5mm, 6mm, and 7mm from tip. Round handle. Overall length: 126mm.		
AH5260	Knolle Spatula and Chamber Gauge	

PHACO SPATULAS

Item #	Description	Image
--------	-------------	-------

Knolle Nucleus Spatula

Straight shaft, 0.5mm wide tip, malleable. Round handle. Overall length: 127mm.

AH5265	Knolle Nucleus Spatula	
--------	--	--



Koch Nucleus Spatula

Curved shaft, 1mm wide, duckbill-shaped tip. Round handle. Overall length: 115mm.

AH5256	Koch Nucleus Spatula, Smooth	
	1mm wide tip.	

AH5255	Koch II-Nucleus Spatula, Notched	
	1mm wide tip with notches.	



Koch Phacoemulsification Spatula

Curved shaft, duckbill-shaped spatula tip, 0.8mm wide tip. Round handle. Overall length: 117mm.

AH5267	Koch Phacoemulsification Spatula	
--------	--	--



Lieppman Nucleus Spatula

Angled shaft, forked tip, 0.5mm wide, blunt tip. Round handle. Overall length: 121mm.

AH5270	Lippman Nucleus Spatula	
--------	---	--



Rowen Phaco Spatula

Double-ended, angled shafts, 9mm from bend to tip, phaco splitter, 60-degree interior cutting edge, blunt tip, 7mm from bend to tip, nucleus rotator, Y-shaped tip. Round handle. Overall length: 143mm.

AH5355	Rowen Phaco Spatula	
--------	-------------------------------------	--



REFRACTIVE SPATULAS

Item #	Description	Image
--------	-------------	-------

Kimura Platinum Spatula

Straight shaft, 34mm shaft, 4mm wide x 17.5mm flat platinum spatula. Flat handle. Overall length: 149mm.

AH5250	Kimura Platinum Spatula	



Maloney PRK Spatula

Angled shaft, 5mm from bend to tip, 2mm wide spatula tip, semi-sharp. Round handle. Overall length: 120mm.

AH5390	Maloney PRK Spatula	

Paton Spatula and Spoon

Double-ended, angled shaft, 8mm from bend to tip, 1.5mm flat spatula, curved 6mm teardrop-shaped spoon with three long openings. Flat handle. Overall length: 140mm.

AH6140	Paton Spatula and Spoon	

RETINAL SPATULAS

Item #	Description	Image
--------	-------------	-------

Maumenee-Barraquer Vitreous Sweep Spatula

Angled shaft, 11mm from bend to tip, spatula blade tip. Round handle. Overall length: 120mm.





AH5124	Maumenee-Barraquer Spatula, Right Right-hand use.	
AH5125	Maumenee-Barraquer Spatula, Left Left-hand use.	



Speculums

The image features a dark blue background with a subtle grid pattern of lighter blue lines. A prominent horizontal bar with a blue-to-white gradient spans the width of the page, positioned below the title. The title 'Speculums' is rendered in a clean, white, sans-serif font.

ADJUSTABLE SPECULUMS

Item #	Description	Image
Cook Eye Speculum		
Pediatric size, 10mm solid round blades, 22mm blade spread, temporal approach, locking screw mechanism. Overall length: 57mm.		
AL0340	Cook Eye Speculum	
Kammann Eye Speculum		
Adult size, 16mm closed K-wire fenestrated blades, self-locking mechanism, 27mm blade spread, temporal approach. Overall length: 70mm.		
AL0450	Kammann Eye Speculum	
Lancaster Eye Speculum		
Adult size, 15mm round solid blades, 35mm blade spread that is spring-controlled with locking mechanism, temporal approach. Overall length: 69mm.		
AL0390	Lancaster Eye Speculum	
Lester-Burch Eye Speculum		
Adult size, 21mm round solid blades, 32mm blade spread, temporal approach, locking screw mechanism. Overall length: 82mm.		
AL0400	Lester-Burch Eye Speculum	

ADJUSTABLE SPECULUMS

Item # **Description** **Image**

Lieberman Adjustable Speculum

Adult and pediatric size Lieberman adjustable speculums available in various blade sizes. The options of titanium or stainless steel with temporal, nasal, and reversible approaches are available. Lid tension is adjustable with thumb-screw control.

AL0521 S **Round, Solid Speculum**
 Pediatric size, 10mm round solid blades, temporal approach.
 Overall length: 73mm.

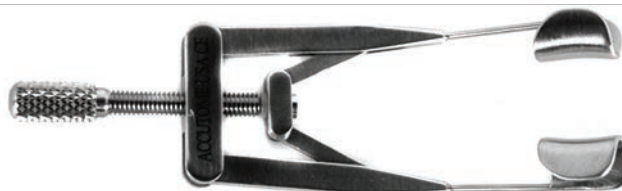

AL0520 S **Round, Solid Speculum**
 Adult size, 14mm round solid blades, reversible approach. Overall length: 90mm.



AL0520 N/K **K-Wire Speculum**
 Adult size, 14mm square open K-wire blades, nasal approach.
 Overall length: 83mm.



AL0520 N/V **V-Wire Speculum**
 Adult size, 14mm open V-wire blades with no flare, nasal approach. Overall length: 83mm.

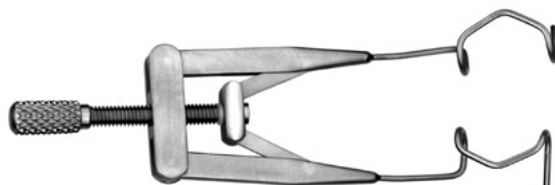

AL0520 T/K **K-Wire Speculum**
 Adult size, 15mm open K-wire blades, temporal approach. Overall length: 90mm.



AL0520 T/K TI **K-Wire Speculum**
 Adult size, titanium, 15mm open K-wire blades, temporal approach. Overall length: 90mm.



AL0520 T/V **V-Wire Speculum**
 Adult size, 15mm open V-wire blades, temporal approach. Overall length: 90mm.



AL0520 T/V TI **V-Wire Speculum**
 Adult size, titanium, 15mm V-wire blades, temporal approach. Overall length: 90mm.



ADJUSTABLE SPECULUMS

Item #	Description	Image
AL0523 T/K	<p>K-Wire Speculum</p> <p>Designed for use during femtosecond cataract surgery. Adult size, 15mm open K-wire blades, temporal approach. Blades are covered in silicone tubing for patient comfort as well as for pushing back the conjunctiva. Overall length: 85mm.</p>	
AL0523 T/V	<p>V-Wire Speculum</p> <p>Designed for use during femtosecond cataract surgery. Adult size, 15mm open V-wire blades, temporal approach. Blades are covered in silicone tubing for patient comfort as well as for pushing back the conjunctiva. Overall length: 85mm.</p>	
AL0525	<p>Round, Solid Speculum</p> <p>Adult size, 15mm round solid, thin blades, temporal approach. Overall length: 76mm.</p>	

Schott Eye Speculum

Adult size, 16mm round closed wire blades, temporal approach, rotatable adjustment for control of blade elevation. Overall length: 140mm.

AL0480	<p>Schott Eye Speculum</p>	
--------	-----------------------------------	--

Williams Eye Speculum

Both adult and pediatric sizes are available in this Williams Eye Speculum. Various blade sizes and spread that are temporal in approach. Comes with a spring-controlled blade spread with screw-type locking mechanism.

AL0490	<p>Adult Eye Speculum</p> <p>Adult size, 14mm closed K-wire blades, 52mm blade spread. Overall length: 86mm.</p>	
AL0500	<p>Pediatric Eye Speculum</p> <p>Pediatric size, 11mm closed K-wire blades, 41mm blade spread. Overall length: 69mm.</p>	

ASPIRATING SPECULUMS

Item #	Description	Image
--------	-------------	-------

Lieberman Aspirating Speculum

Adult size, 12mm open K-wire blades, temporal approach, lid tension adjustable with thumb-screw control, supplied with silicone tubing and luer-lock adapter. Overall length: 82mm.

AL0530	Lieberman Aspirating Speculum	
--------	---	--



Machat LASIK Speculum

Aspirating and non-aspirating Machat LASIK speculums. Both are adult size with 17mm open V-wire blades, temporal approach, and have thumb-screw control for lid tension. Overall length: 76mm.

AL0533	Machat Aspirating Speculum Aspirating speculum.	
--------	--	--



AL0534	Machat Adjustable Speculum Non-aspirating speculum.	
--------	--	--

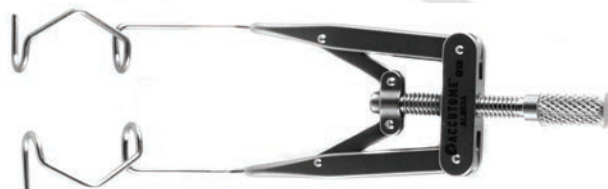

WIRE SPECULUMS

Item #	Description	Image
--------	-------------	-------

Varley LASIK/Femtosecond Lid Speculum

Adult size, 14mm open K-wire blades with modified bent shafts, 0.039 stainless steel wire, 30mm blade spread, temporal approach. Overall length: 60mm.

AL3190	Varley LASIK/Femtosecond Lid Speculum	
--------	---	--

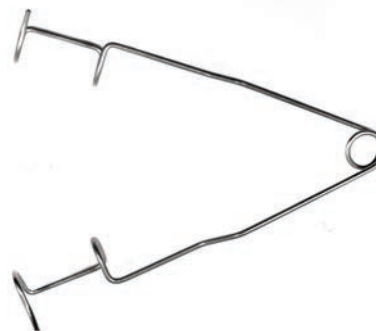

WIRE SPECULUMS

Item #	Description	Image
--------	-------------	-------

Alfonso Eye Speculum

Newborn size speculums available in both regular wire and heavy wire. 5mm closed K-wire blades with 27mm spread, temporal approach. Dull finish. Overall length: 45mm.

AL0300	Wire Newborn Speculum	
--------	------------------------------	--

Standard wire.

AL0301	Heavy Wire Newborn Speculum	
--------	------------------------------------	--

Heavy wire.

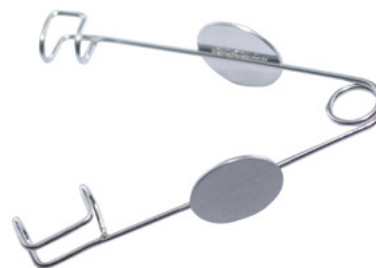
**Barraquer Lid Speculum**

A variety of Barraquer eye speculums in both adult and pediatric sizes. Solid, closed, and open blades that are both temporal and nasal in approach are available.

AL0190	K-Wire Speculum	
--------	------------------------	--

Infant size, 4mm open K-wire blades, 15mm blade spread, temporal approach. Overall length: 31mm.

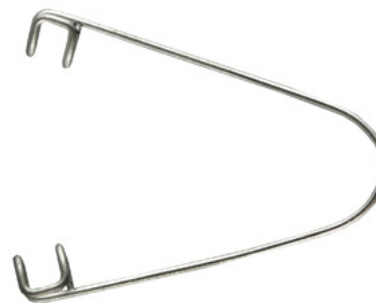



AL0141	K-Wire Speculum	
--------	------------------------	--

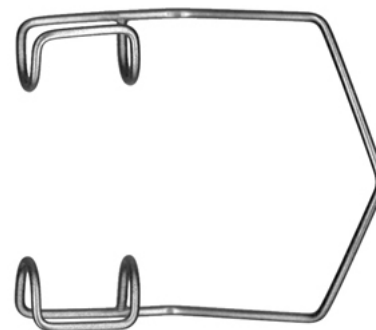

Pediatric size, 8mm closed K-wire blades, 15mm blade spread, temporal approach. Overall length: 32mm.

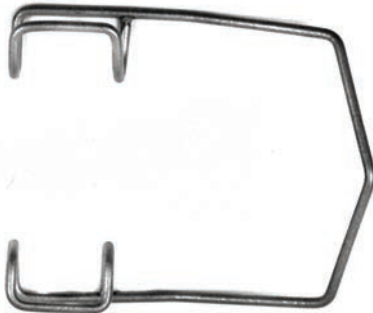

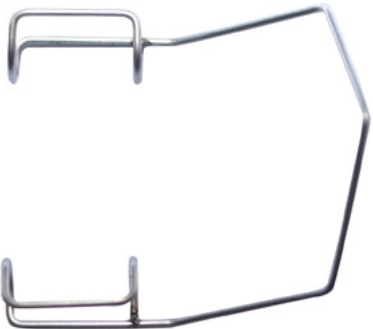
WIRE SPECULUMS

Item #	Description	Image
AL0145 H	<p data-bbox="261 321 418 342">K-Wire Speculum</p> <p data-bbox="261 354 781 401">Pediatric size, 9mm heavy closed K-wire blades, 11mm blade spread, temporal approach. Overall length: 30mm.</p>	
AL0100	<p data-bbox="261 701 472 722">Round, Solid Speculum</p> <p data-bbox="261 732 781 781">Pediatric size, 10mm round solid blades, 15mm blade spread, temporal approach. Overall length: 38mm.</p>	
AL0140	<p data-bbox="261 1087 467 1108">Round, Wire Speculum</p> <p data-bbox="261 1117 781 1167">Pediatric size, 11mm round closed wire blades, 15mm blade spread, temporal approach. Overall length: 38mm.</p>	
AL0140S	<p data-bbox="261 1472 418 1493">K-Wire Speculum</p> <p data-bbox="261 1501 781 1551">Pediatric size, 11mm closed K-wire blades, square, 19mm blade spread, temporal approach. Overall length: 35mm.</p>	

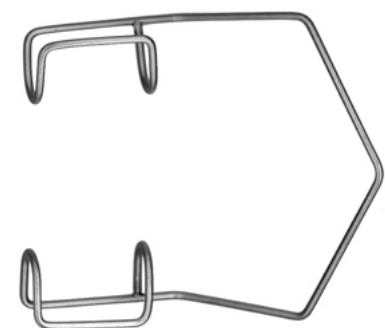
WIRE SPECULUMS

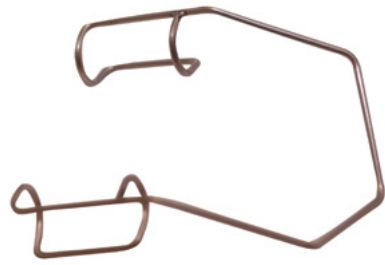
Item #	Description	Image
AL0121 S	<p data-bbox="256 315 414 346">K-Wire Speculum</p> <p data-bbox="256 346 779 409">Adult size, 12mm closed K-wire blades, 18mm blade spread, temporal approach. Overall length: 32mm.</p>	 <p>A wire speculum with two closed K-wire blades. The blades are positioned to provide a temporal approach. The overall length is 32mm.</p>
AL0110	<p data-bbox="256 693 470 724">Round, Solid Speculum</p> <p data-bbox="256 724 779 787">Adult size, 14mm solid rounded blades, 18mm blade spread, temporal approach. Overall length: 41mm.</p>	 <p>A solid speculum with two rounded blades. The blades are positioned to provide a temporal approach. The overall length is 41mm.</p>
AL0120	<p data-bbox="256 1081 462 1113">Round, Wire Speculum</p> <p data-bbox="256 1113 779 1176">Adult size, 14mm round closed wire blades, 18mm blade spread, temporal approach. Overall length: 38mm.</p>	 <p>A wire speculum with two round closed wire blades. The blades are positioned to provide a temporal approach. The overall length is 38mm.</p>
AL0120 S	<p data-bbox="256 1459 414 1491">K-Wire Speculum</p> <p data-bbox="256 1491 779 1554">Adult size, 14mm closed K-wire blades, 18mm blade spread, temporal approach. Overall length: 38mm.</p>	 <p>A wire speculum with two closed K-wire blades. The blades are positioned to provide a temporal approach. The overall length is 38mm.</p>

WIRE SPECULUMS

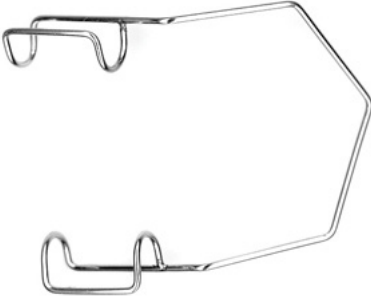
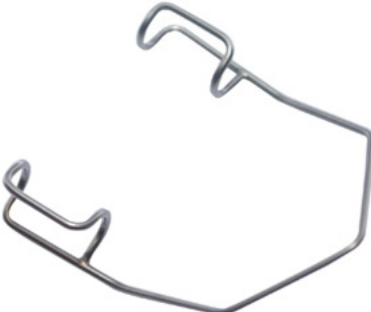
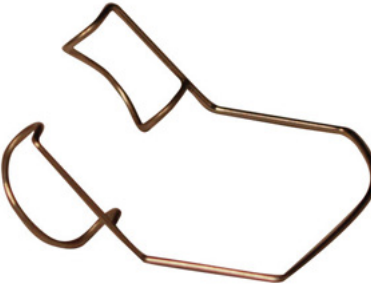
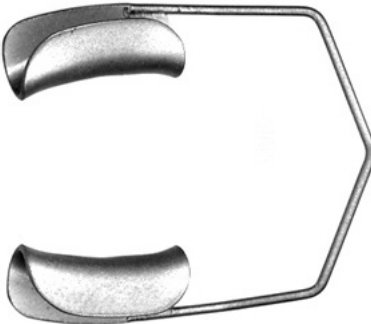
Item #	Description	Image
AL0126	<p data-bbox="261 321 418 342">K-Wire Speculum</p> <p data-bbox="261 354 776 401">Adult size, 14mm closed K-wire blades, 18mm blade spread, nasal approach. Overall length: 38mm.</p>	
AL0130	<p data-bbox="261 701 418 722">K-Wire Speculum</p> <p data-bbox="261 735 753 781">Adult size, 14mm closed K-wire blades, heavy wire, 18mm blade spread, temporal approach. Overall length: 38mm.</p>	
AL0180	<p data-bbox="261 1085 467 1106">Round, Wire Speculum</p> <p data-bbox="261 1119 743 1165">Adult size, 14mm round closed wire blades, 18mm blade spread, temporal approach. Overall length 38mm.</p>	
AL0143	<p data-bbox="261 1467 472 1488">Round, Solid Speculum</p> <p data-bbox="261 1501 786 1547">Pediatric size, 14mm solid round blades, 18mm blade spread, temporal approach. Dull finish. Overall length: 41mm.</p>	

WIRE SPECULUMS

Item #	Description	Image
--------	-------------	-------

Floyd-Barraquer Eye Speculum

Adult size, 14mm closed round wire blades with 6mm lifting wings, 18mm blade spread, temporal approach. Overall length: 40mm.

AL0133	Floyd-Barraquer Eye Speculum	
--------	--	---

Kratz-Barraquer Eye Speculum

Adult and pediatric sizes with open K-wire blades and temporal approach.

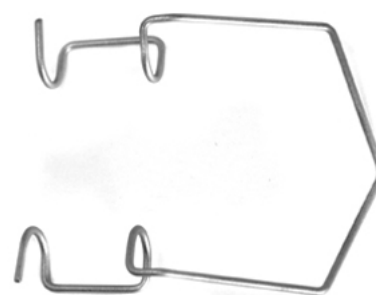
AL0160	10mm Eye Speculum	
AL0150	14mm Eye Speculum	
AL0165	14mm Eye Speculum	

Pediatric size, 10mm blades, 19mm blade spread, temporal approach. Overall length: 35mm.

Adult size, 14mm blades, 18mm blade spread, temporal approach. Overall length: 41mm.

Adult size, 14mm heavy wire blades, 18mm blade spread, temporal approach. Overall length: 38mm.

Kratz-Nichamin Lid Speculum

Adult size, 16mm open K-wire blades, temporal approach, wing tip twist that gives the surgeon better on-axis accessibility. Overall length: 45mm.

AL0151	Kratz-Nichamin Lid Speculum	
--------	---	--

WIRE SPECULUMS

Item #	Description	Image
--------	-------------	-------

Lehner Lid Speculum

Adult size, 14mm open K-wire blades, heavy wire, 18mm blade spread, temporal approach, angled up 45 degrees. Overall length: 38mm.

AL0153	Lehner Lid Speculum	
--------	-------------------------------------	--

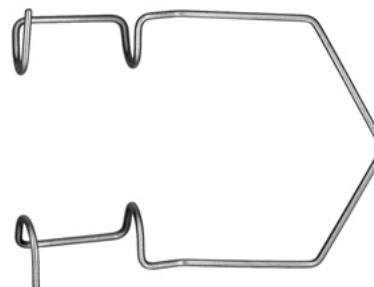
**Sauer Eye Speculum**

Infant size, 8mm round solid blades, 22mm blade spread, temporal approach. Overall length: 34mm.

AL0470	Infant Sauer Eye Speculum	
--------	---	--

**Slade Refractive Speculum**

Adult size, 0.035 stainless steel wire, 15mm round open wire blades with flared tips. Temporal approach. Overall length: 41mm.

AL0175	Slade Refractive Wire Speculum	
--------	--	--

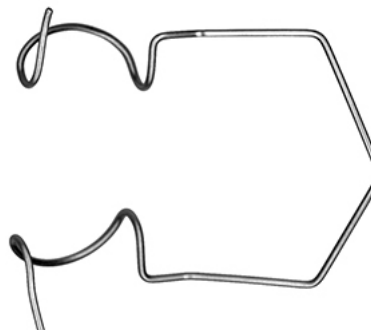

WIRE SPECULUMS

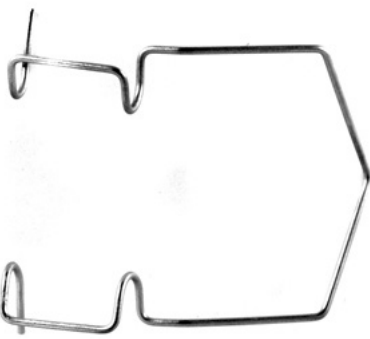
Item #	Description	Image
Temporal Approach Wire Speculum		
Adult size wire speculums with temporal approach. K-wire or round blade options with 18mm blade spread in stainless steel.		
AL0152	Round Temporal Speculum 14mm round closed blades. Overall length: 41mm.	 A wire speculum with two rounded blades that meet at the tip, forming a closed shape. The blades are connected by a thin wire handle.
AL0185	Square Temporal Speculum 14mm open K-wire blades. Overall length: 38mm.	 A wire speculum with two blades that are open at the tip, forming a square shape. The blades are connected by a thin wire handle.

Spoons

The image features a dark blue background with a subtle pattern of white keyboard keys. A bright blue horizontal bar spans the width of the page, positioned below the title. The title 'Spoons' is written in a clean, white, sans-serif font on the left side of the page.

EVISCERATION & ENUCLEATION SPOONS

Item #	Description	Image
Bunge Evisceration Spoon		
Straight shaft, spoon blade, flat, smooth. Flat handle.		
AH6120	8mm Bunge Evisceration Spoon 8mm diameter spoon blade. Overall length: 136mm.	
AH6110	12mm Bunge Evisceration Spoon 12mm diameter spoon blade. Overall length: 140mm.	

Wells Enucleation Spoon

Straight shaft, curved spoon tip, 21mm wide spoon, 5mm wide x 10mm long notch in spoon. Flat handle. Overall length: 147mm.



AH6150	Wells Enucleation Spoon	
--------	--------------------------------	--

LENS SPOONS

Item #	Description	Image
Culler Lens Spoon		
Straight shaft, spoon-shaped tip, 5mm wide x 9mm long tip, solid middle. Flat handle. Overall length: 137mm.		
AH6130	Culler Lens Spoon	

Sterilization Trays

METAL TRAYS

Item #	Description	Image
Metal Microsurgical Instrument Sterilization Tray		
Aluminum metal microsurgical instrument sterilization trays with hinged lids. Available in various sizes and comes as a single or double layer.		
AT0242	<p data-bbox="261 430 454 451">Two-Layer Metal Tray</p> <p data-bbox="261 466 787 514">Two layers with pin mat and retainers. External size: 10.5"W x 10.5"L x 2.5"H. Internal size: 9.84"W x 10.2"L x 2.32"H.</p>	
AT0281	<p data-bbox="261 808 454 829">Two-Layer Metal Tray</p> <p data-bbox="261 844 787 913">Two layers with pin mat, retainers, short tray, and full-height accessory area. External size: 15"W x 10.5"L x 2.5"H. Internal size: 9.84"W x 14.60"L x 2.32"H.</p>	
AT0241	<p data-bbox="261 1186 479 1207">Single-Layer Metal Tray</p> <p data-bbox="261 1222 787 1270">Single layer with pin mat and retainers. External size: 10.5"W x 10.5"L x 1.5"H. Internal size: 9.84"W x 10.2"L x 1.23"H.</p>	

PLASTIC TRAYS

Item #	Description	Image
Diamond Knife Tray		
Plastic single-layer tray. Includes base, lid, and holder for up to three knives. Loose lid. Small size - 2.5"W x 6"L x 0.75"H.		
AT0200	Diamond Knife Tray	
Plastic Microsurgical Instrument Sterilization Tray		
Various plastic microsurgical trays used for instrument sterilization with lid and silicone finger mats. Comes in a variety of different sizes. Loose lid.		
AT0155	Accutome Sterilization Tray, Small	
Plastic single-layer tray. Includes base, lid, and silicone finger mat. Small size - 4"W x 7.5"L x 1.5"H.		
AT0210	Accutome Sterilization Tray, Small	
Plastic single-layer tray. Includes base, lid, and silicone finger mat. Small size - 2.5"W x 6"L x 0.75"H.		
AT0225	Accutome Sterilization Tray, Small	
Plastic single-layer tray. Includes base, lid, and silicone finger mat. Small size - 4"W x 7.5"L x 0.75"H.		
AT0190	Accutome Sterilization Tray, Medium	
Plastic single-layer tray. Includes base, lid, and silicone finger mat. Medium size - 6"W x 10"L x 0.75"H.		
AT0195	Accutome Sterilization Tray, Medium	
Plastic single-layer tray. Includes deep base, lid, and silicone finger mat. Medium size - 6"W x 10"L x 1.5"H.		

PLASTIC TRAYS

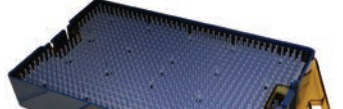
Item #	Description	Image
AT0170	<p>Accutome Sterilization Tray, Medium</p> <p>Plastic double-layer tray. Includes extra-deep base, insert tray, lid, and two silicone finger mats. Medium size - 6"W x 10"L x 1.5"H.</p>	

AT0160	<p>Accutome Sterilization Tray, Large</p> <p>Plastic single-layer tray. Includes base, lid, and silicone finger mat. Large size - 10"W x 15"L x 0.75"H.</p>	
--------	--	--

Plastic Phaco Instrument Sterilization Tray

Plastic Phaco single-layer instrument sterilization trays come with a base, lid, bars, and slots. Loose lid.

AT0600	<p>1-Slot Phaco Tray</p> <p>Includes base, lid, 2 bars, and 1 slot. Medium size - 6"W x 10"L x 1.5"H.</p>	
AT0601	<p>3-Slot Phaco Tray</p> <p>Includes base, lid, 2 bars, and 3 slots. Medium size - 6"W x 10"L x 1.5"H.</p>	

Sterilization Tray Replacement Mat

Silicone finger mat for use in Accutome medium sterilization tray (AT0170). Light blue in color and has perforated bottom for draining. Medium size - 6"W x 10"L.

AT0170 BTTM MAT	Sterilization Tray Replacement Mat	
-----------------	---	--

Trephines & Punches

DISPOSABLE TREPHINES & PUNCHES

Item #	Description	Image
--------	-------------	-------

Disposable Radial Vacuum Trephine

Our sterile, single-use vacuum trephines consistently create accurate and uniform cuts by dividing the corneal chamber into 16 chambers, thus reducing corneal distortion. The ergonomic grip allows for easier control while making precision cuts on patient corneas. 16 radial marks allow for easy suture placement. Sold individually.

AB-67600	6.00mm Disposable Trephine 6.00mm diameter.
AB-67650	6.50mm Disposable Trephine 6.50mm diameter.
AB-67700	7.00mm Disposable Trephine 7.00mm diameter.
AB-67725	7.25mm Disposable Trephine 7.25mm diameter.
AB-67750	7.50mm Disposable Trephine 7.50mm diameter.
AB-67775	7.75mm Disposable Trephine 7.75mm diameter.
AB-67800	8.00mm Disposable Trephine 8.00mm diameter.
AB-67825	8.25mm Disposable Trephine 8.25mm diameter.
AB-67850	8.50mm Disposable Trephine 8.50mm diameter.
AB-67875	8.75mm Disposable Trephine 8.75mm diameter.
AB-67900	9.00mm Disposable Trephine 9.00mm diameter.



Vacuum Donor Punch

Our sterile, single-use vacuum donor punches have an ultra-sharp cutting blade for making precision cuts of the donor tissue for corneal transplants. The punches feature four guide posts that ensure proper alignment. Sold individually.

AB-60600	6.00mm Disposable Punch 6.00mm diameter.
AB-60625	6.25mm Disposable Punch 6.25mm diameter.
AB-60650	6.50mm Disposable Punch 6.50mm diameter.
AB-60675	6.75mm Disposable Punch 6.75mm diameter.
AB-60700	7.00mm Disposable Punch 7.00mm diameter.
AB-60725	7.25mm Disposable Punch 7.25mm diameter.
AB-60750	7.50mm Disposable Punch 7.50mm diameter.



DISPOSABLE TREPHINES & PUNCHES

Item #	Description	Image
AB-60775	7.75mm Disposable Punch 7.75mm diameter.	
AB-60785	7.85mm Disposable Punch 7.85mm diameter.	
AB-60800	8.00mm Disposable Punch 8.00mm diameter.	
AB-60825	8.25mm Disposable Punch 8.25mm diameter.	
AB-60850	8.50mm Disposable Punch 8.50mm diameter.	
AB-60875	8.75mm Disposable Punch 8.75mm diameter.	
AB-60900	9.00mm Disposable Punch 9.00mm diameter.	
AB-60925	9.25mm Disposable Punch 9.25mm diameter.	
AB-60950	9.50mm Disposable Punch 9.50mm diameter.	

REUSABLE TREPHINES & PUNCHES

Item #	Description	Image
Long Reusable Trephine Blade		
Stainless steel, long, reusable trephine blades range in diameter from 2mm to 16mm. All blades are 15mm in length and are sold individually.		
AM0570 20	2mm Long Trephine 2mm diameter blade tip.	
AM0570 25	2.5mm Long Trephine 2.5mm diameter blade tip.	
AM0570 30	3mm Long Trephine 3mm diameter blade tip.	
AM0570 40	4mm Long Trephine 4mm diameter blade tip.	
AM0570 45	4.5mm Long Trephine 4.5mm diameter blade tip.	
AM0570 50	5mm Long Trephine 5mm diameter blade tip.	
AM0570 60	6mm Long Trephine 6mm diameter blade tip.	
AM0570 65	6.5mm Long Trephine 6.5mm diameter blade tip.	
AM0570 67	6.75mm Long Trephine 6.75mm diameter blade tip.	

REUSABLE TREPHINES & PUNCHES

Item #	Description	Image
AM0570 70	7mm Long Trephine 7mm diameter blade tip.	
AM0570 72	7.25mm Long Trephine 7.25mm diameter blade tip.	
AM0570 75	7.5mm Long Trephine 7.5mm diameter blade tip.	
AM0570 77	7.75mm Long Trephine 7.75mm diameter blade tip.	
AM0570 80	8mm Long Trephine 8mm diameter blade tip.	
AM0570 82	8.25mm Long Trephine 8.25mm diameter blade tip.	
AM0570 85	8.5mm Long Trephine 8.5mm diameter blade tip.	
AM0570 87	8.75mm Long Trephine 8.75mm diameter blade tip.	
AM0570 90	9mm Long Trephine 9mm diameter blade tip.	
AM0570 95	9.5mm Long Trephine 9.5mm diameter blade tip.	
AM0570 100	10mm Long Trephine 10mm diameter blade tip.	
AM0570 105	10.5mm Long Trephine 10.5mm diameter blade tip.	
AM0570 110	11mm Long Trephine 11mm diameter blade tip.	
AM0570 115	11.5mm Long Trephine 11.5mm diameter blade tip.	
AM0570 140	14mm Long Trephine 14mm diameter blade tip.	
AM0570 15	15mm Long Trephine 15mm diameter blade tip.	
AM0570 160	16mm Long Trephine 16mm diameter blade tip.	

REUSABLE TREPHINES & PUNCHES

Item #	Description	Image
Universal Trephine Blade Holder		
Stainless steel, adjustable fingerlike tips that rest in the grooved disposable trephine blades, fits 3mm to 10mm short and long trephine blades. Round handle with screw-type adjustable spread. Overall length: 49mm.		
AM0510	Universal Trephine Blade Holder	







Sutures

NYLON

Item # **Description** **Image**

Sutures 11-0 Nylon



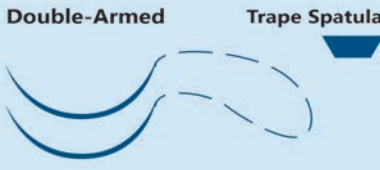
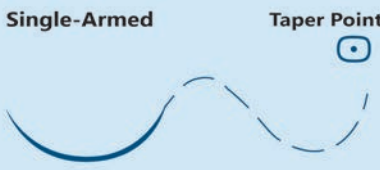
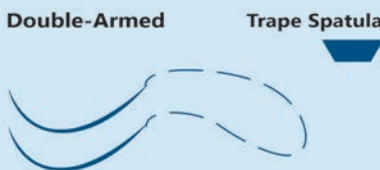
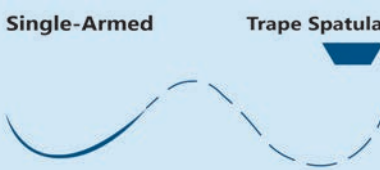
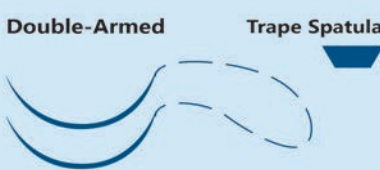
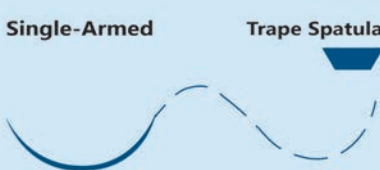
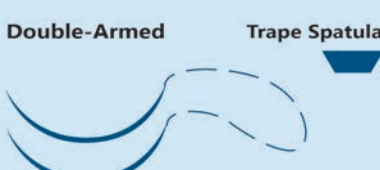

Mani brand 11-0, black mono, nylon sutures with both single and double arms. Taper point and trape spatula needles ranging in length, curve, and diameter. Mani sutures are ideal for micro-suturing on the cornea and sclera during eye surgery. Ultimate sharpness is obtained through the “cross-lapped edge” technique giving each suture a fine and sharp tip ensuring minimally invasive wound closure. Mani hard fiber stainless steel is used to make strong and break-resistant needles. Sold 12 per box.

AB-0550S	<p>Nylon Suture, Taper Point</p> <p>Single-armed suture, measures 13cm in length. Taper point needle, measures 4.0mm in length, 3/8 curve, and 0.05mm in diameter.</p>	<p>Single-Armed Taper Point</p> 	<table border="1"> <thead> <tr> <th colspan="2">Suture</th> </tr> </thead> <tbody> <tr> <td>Description</td> <td>Nylon, Black Mono</td> </tr> <tr> <td>Length (cm)</td> <td>13</td> </tr> <tr> <td>Size</td> <td>11-0 (0.1 metric)</td> </tr> </tbody> </table> <table border="1"> <thead> <tr> <th colspan="2">Needle</th> </tr> </thead> <tbody> <tr> <td>Length (mm)</td> <td>4.0</td> </tr> <tr> <td>Curve</td> <td>3/8</td> </tr> <tr> <td>Diam. (mm)</td> <td>0.05</td> </tr> </tbody> </table>	Suture		Description	Nylon, Black Mono	Length (cm)	13	Size	11-0 (0.1 metric)	Needle		Length (mm)	4.0	Curve	3/8	Diam. (mm)	0.05
Suture																			
Description	Nylon, Black Mono																		
Length (cm)	13																		
Size	11-0 (0.1 metric)																		
Needle																			
Length (mm)	4.0																		
Curve	3/8																		
Diam. (mm)	0.05																		
AB-1476	<p>Nylon Suture, Trape Spatula</p> <p>Double-armed suture, measures 30cm in length. Trape spatula needle, measures 5.5mm in length, 7/16 curve, and 0.14mm in diameter.</p>	<p>Double-Armed Trape Spatula</p> 	<table border="1"> <thead> <tr> <th colspan="2">Suture</th> </tr> </thead> <tbody> <tr> <td>Description</td> <td>Nylon, Black Mono</td> </tr> <tr> <td>Length (cm)</td> <td>30</td> </tr> <tr> <td>Size</td> <td>11-0 (0.1 metric)</td> </tr> </tbody> </table> <table border="1"> <thead> <tr> <th colspan="2">Needle</th> </tr> </thead> <tbody> <tr> <td>Length (mm)</td> <td>5.5</td> </tr> <tr> <td>Curve</td> <td>7/16</td> </tr> <tr> <td>Diam. (mm)</td> <td>0.14</td> </tr> </tbody> </table>	Suture		Description	Nylon, Black Mono	Length (cm)	30	Size	11-0 (0.1 metric)	Needle		Length (mm)	5.5	Curve	7/16	Diam. (mm)	0.14
Suture																			
Description	Nylon, Black Mono																		
Length (cm)	30																		
Size	11-0 (0.1 metric)																		
Needle																			
Length (mm)	5.5																		
Curve	7/16																		
Diam. (mm)	0.14																		
AB-1403	<p>Nylon Suture, Trape Spatula</p> <p>Double-armed suture, measures 20cm in length. Trape spatula needle, measures 5.5mm in length, 7/16 curve, and 0.14mm in diameter.</p>	<p>Double-Armed Trape Spatula</p> 	<table border="1"> <thead> <tr> <th colspan="2">Suture</th> </tr> </thead> <tbody> <tr> <td>Description</td> <td>Nylon, Black Mono</td> </tr> <tr> <td>Length (cm)</td> <td>20</td> </tr> <tr> <td>Size</td> <td>11-0 (0.1 metric)</td> </tr> </tbody> </table> <table border="1"> <thead> <tr> <th colspan="2">Needle</th> </tr> </thead> <tbody> <tr> <td>Length (mm)</td> <td>5.5</td> </tr> <tr> <td>Curve</td> <td>7/16</td> </tr> <tr> <td>Diam. (mm)</td> <td>0.14</td> </tr> </tbody> </table>	Suture		Description	Nylon, Black Mono	Length (cm)	20	Size	11-0 (0.1 metric)	Needle		Length (mm)	5.5	Curve	7/16	Diam. (mm)	0.14
Suture																			
Description	Nylon, Black Mono																		
Length (cm)	20																		
Size	11-0 (0.1 metric)																		
Needle																			
Length (mm)	5.5																		
Curve	7/16																		
Diam. (mm)	0.14																		
AB-1000	<p>Nylon Suture, Trape Spatula</p> <p>Double-armed suture, measures 20cm in length. Trape spatula needle, measures 5.5mm in length, 7/16 curve, and 0.10mm in diameter.</p>	<p>Double-Armed Trape Spatula</p> 	<table border="1"> <thead> <tr> <th colspan="2">Suture</th> </tr> </thead> <tbody> <tr> <td>Description</td> <td>Nylon, Black Mono</td> </tr> <tr> <td>Length (cm)</td> <td>20</td> </tr> <tr> <td>Size</td> <td>11-0 (0.1 metric)</td> </tr> </tbody> </table> <table border="1"> <thead> <tr> <th colspan="2">Needle</th> </tr> </thead> <tbody> <tr> <td>Length (mm)</td> <td>5.5</td> </tr> <tr> <td>Curve</td> <td>7/16</td> </tr> <tr> <td>Diam. (mm)</td> <td>0.10</td> </tr> </tbody> </table>	Suture		Description	Nylon, Black Mono	Length (cm)	20	Size	11-0 (0.1 metric)	Needle		Length (mm)	5.5	Curve	7/16	Diam. (mm)	0.10
Suture																			
Description	Nylon, Black Mono																		
Length (cm)	20																		
Size	11-0 (0.1 metric)																		
Needle																			
Length (mm)	5.5																		
Curve	7/16																		
Diam. (mm)	0.10																		
AB-1000S	<p>Nylon Suture, Trape Spatula</p> <p>Single-armed suture, measures 10cm in length. Trape spatula needle, measures 5.5mm in length, 7/16 curve, and 0.10mm in diameter.</p>	<p>Single-Armed Trape Spatula</p> 	<table border="1"> <thead> <tr> <th colspan="2">Suture</th> </tr> </thead> <tbody> <tr> <td>Description</td> <td>Nylon, Black Mono</td> </tr> <tr> <td>Length (cm)</td> <td>10</td> </tr> <tr> <td>Size</td> <td>11-0 (0.1 metric)</td> </tr> </tbody> </table> <table border="1"> <thead> <tr> <th colspan="2">Needle</th> </tr> </thead> <tbody> <tr> <td>Length (mm)</td> <td>5.5</td> </tr> <tr> <td>Curve</td> <td>7/16</td> </tr> <tr> <td>Diam. (mm)</td> <td>0.10</td> </tr> </tbody> </table>	Suture		Description	Nylon, Black Mono	Length (cm)	10	Size	11-0 (0.1 metric)	Needle		Length (mm)	5.5	Curve	7/16	Diam. (mm)	0.10
Suture																			
Description	Nylon, Black Mono																		
Length (cm)	10																		
Size	11-0 (0.1 metric)																		
Needle																			
Length (mm)	5.5																		
Curve	7/16																		
Diam. (mm)	0.10																		
AB-1478S	<p>Nylon Suture, Trape Spatula</p> <p>Single-armed suture, measures 15cm in length. Trape spatula needle, measures 6.0mm in length, 3/8 curve, and 0.14mm in diameter.</p>	<p>Single-Armed Trape Spatula</p> 	<table border="1"> <thead> <tr> <th colspan="2">Suture</th> </tr> </thead> <tbody> <tr> <td>Description</td> <td>Nylon, Black Mono</td> </tr> <tr> <td>Length (cm)</td> <td>15</td> </tr> <tr> <td>Size</td> <td>11-0 (0.1 metric)</td> </tr> </tbody> </table> <table border="1"> <thead> <tr> <th colspan="2">Needle</th> </tr> </thead> <tbody> <tr> <td>Length (mm)</td> <td>6.0</td> </tr> <tr> <td>Curve</td> <td>3/8</td> </tr> <tr> <td>Diam. (mm)</td> <td>0.14</td> </tr> </tbody> </table>	Suture		Description	Nylon, Black Mono	Length (cm)	15	Size	11-0 (0.1 metric)	Needle		Length (mm)	6.0	Curve	3/8	Diam. (mm)	0.14
Suture																			
Description	Nylon, Black Mono																		
Length (cm)	15																		
Size	11-0 (0.1 metric)																		
Needle																			
Length (mm)	6.0																		
Curve	3/8																		
Diam. (mm)	0.14																		

NYLON

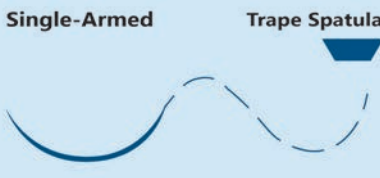
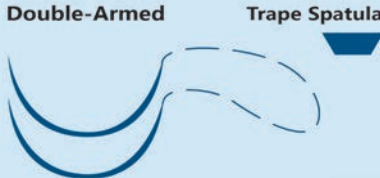
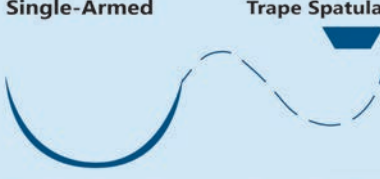
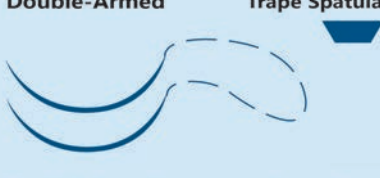
Item #	Description	Image																
Sutures 10-0 Nylon																		
AB-1001	<p>Nylon Suture, Trape Spatula</p> <p>Double-armed suture, measures 30cm in length. Trape spatula needle, measures 5.5mm in length, 7/16 curve, and 0.10mm in diameter.</p>	 <table border="1"> <thead> <tr> <th colspan="2">Suture</th> </tr> </thead> <tbody> <tr> <td>Description</td> <td>Nylon, Black Mono</td> </tr> <tr> <td>Length (cm)</td> <td>30</td> </tr> <tr> <td>Size</td> <td>10-0 (0.2 metric)</td> </tr> </tbody> </table> <table border="1"> <thead> <tr> <th colspan="2">Needle</th> </tr> </thead> <tbody> <tr> <td>Length (mm)</td> <td>5.5</td> </tr> <tr> <td>Curve</td> <td>7/16</td> </tr> <tr> <td>Diam. (mm)</td> <td>0.10</td> </tr> </tbody> </table>	Suture		Description	Nylon, Black Mono	Length (cm)	30	Size	10-0 (0.2 metric)	Needle		Length (mm)	5.5	Curve	7/16	Diam. (mm)	0.10
Suture																		
Description	Nylon, Black Mono																	
Length (cm)	30																	
Size	10-0 (0.2 metric)																	
Needle																		
Length (mm)	5.5																	
Curve	7/16																	
Diam. (mm)	0.10																	
AB-1052S	<p>Nylon Suture, Taper Point</p> <p>Single-armed suture, measures 20cm in length. Taper point needle, measures 5.0mm in length, 3/8 curve, and 0.10mm in diameter.</p>	 <table border="1"> <thead> <tr> <th colspan="2">Suture</th> </tr> </thead> <tbody> <tr> <td>Description</td> <td>Nylon, Black Mono</td> </tr> <tr> <td>Length (cm)</td> <td>20</td> </tr> <tr> <td>Size</td> <td>10-0 (0.2 metric)</td> </tr> </tbody> </table> <table border="1"> <thead> <tr> <th colspan="2">Needle</th> </tr> </thead> <tbody> <tr> <td>Length (mm)</td> <td>5.0</td> </tr> <tr> <td>Curve</td> <td>3/8</td> </tr> <tr> <td>Diam. (mm)</td> <td>0.10</td> </tr> </tbody> </table>	Suture		Description	Nylon, Black Mono	Length (cm)	20	Size	10-0 (0.2 metric)	Needle		Length (mm)	5.0	Curve	3/8	Diam. (mm)	0.10
Suture																		
Description	Nylon, Black Mono																	
Length (cm)	20																	
Size	10-0 (0.2 metric)																	
Needle																		
Length (mm)	5.0																	
Curve	3/8																	
Diam. (mm)	0.10																	
AB-1401	<p>Nylon Suture, Trape Spatula</p> <p>Double-armed suture, measures 30cm in length. Trape spatula needle, measures 5.0mm in length, bi-curve, and 0.14mm in diameter.</p>	 <table border="1"> <thead> <tr> <th colspan="2">Suture</th> </tr> </thead> <tbody> <tr> <td>Description</td> <td>Nylon, Black Mono</td> </tr> <tr> <td>Length (cm)</td> <td>30</td> </tr> <tr> <td>Size</td> <td>10-0 (0.2 metric)</td> </tr> </tbody> </table> <table border="1"> <thead> <tr> <th colspan="2">Needle</th> </tr> </thead> <tbody> <tr> <td>Length (mm)</td> <td>5.0</td> </tr> <tr> <td>Curve</td> <td>Bi-curve</td> </tr> <tr> <td>Diam. (mm)</td> <td>0.14</td> </tr> </tbody> </table>	Suture		Description	Nylon, Black Mono	Length (cm)	30	Size	10-0 (0.2 metric)	Needle		Length (mm)	5.0	Curve	Bi-curve	Diam. (mm)	0.14
Suture																		
Description	Nylon, Black Mono																	
Length (cm)	30																	
Size	10-0 (0.2 metric)																	
Needle																		
Length (mm)	5.0																	
Curve	Bi-curve																	
Diam. (mm)	0.14																	
AB-1401S	<p>Nylon Suture, Trape Spatula</p> <p>Single-armed suture, measures 15cm in length. Trape spatula needle, measures 5.0mm in length, bi-curve, and 0.14mm in diameter.</p>	 <table border="1"> <thead> <tr> <th colspan="2">Suture</th> </tr> </thead> <tbody> <tr> <td>Description</td> <td>Nylon, Black Mono</td> </tr> <tr> <td>Length (cm)</td> <td>15</td> </tr> <tr> <td>Size</td> <td>10-0 (0.2 metric)</td> </tr> </tbody> </table> <table border="1"> <thead> <tr> <th colspan="2">Needle</th> </tr> </thead> <tbody> <tr> <td>Length (mm)</td> <td>5.0</td> </tr> <tr> <td>Curve</td> <td>Bi-curve</td> </tr> <tr> <td>Diam. (mm)</td> <td>0.14</td> </tr> </tbody> </table>	Suture		Description	Nylon, Black Mono	Length (cm)	15	Size	10-0 (0.2 metric)	Needle		Length (mm)	5.0	Curve	Bi-curve	Diam. (mm)	0.14
Suture																		
Description	Nylon, Black Mono																	
Length (cm)	15																	
Size	10-0 (0.2 metric)																	
Needle																		
Length (mm)	5.0																	
Curve	Bi-curve																	
Diam. (mm)	0.14																	
AB-1404	<p>Nylon Suture, Trape Spatula</p> <p>Double-armed suture, measures 30cm in length. Trape spatula needle, measures 5.5mm in length, 7/16 curve, and 0.14mm in diameter.</p>	 <table border="1"> <thead> <tr> <th colspan="2">Suture</th> </tr> </thead> <tbody> <tr> <td>Description</td> <td>Nylon, Black Mono</td> </tr> <tr> <td>Length (cm)</td> <td>30</td> </tr> <tr> <td>Size</td> <td>10-0 (0.2 metric)</td> </tr> </tbody> </table> <table border="1"> <thead> <tr> <th colspan="2">Needle</th> </tr> </thead> <tbody> <tr> <td>Length (mm)</td> <td>5.5</td> </tr> <tr> <td>Curve</td> <td>7/16</td> </tr> <tr> <td>Diam. (mm)</td> <td>0.14</td> </tr> </tbody> </table>	Suture		Description	Nylon, Black Mono	Length (cm)	30	Size	10-0 (0.2 metric)	Needle		Length (mm)	5.5	Curve	7/16	Diam. (mm)	0.14
Suture																		
Description	Nylon, Black Mono																	
Length (cm)	30																	
Size	10-0 (0.2 metric)																	
Needle																		
Length (mm)	5.5																	
Curve	7/16																	
Diam. (mm)	0.14																	
AB-1404S	<p>Nylon Suture, Trape Spatula</p> <p>Single-armed suture, measures 15cm in length. Trape spatula needle, measures 5.5mm in length, 7/16 curve, and 0.14mm in diameter.</p>	 <table border="1"> <thead> <tr> <th colspan="2">Suture</th> </tr> </thead> <tbody> <tr> <td>Description</td> <td>Nylon, Black Mono</td> </tr> <tr> <td>Length (cm)</td> <td>15</td> </tr> <tr> <td>Size</td> <td>10-0 (0.2 metric)</td> </tr> </tbody> </table> <table border="1"> <thead> <tr> <th colspan="2">Needle</th> </tr> </thead> <tbody> <tr> <td>Length (mm)</td> <td>5.5</td> </tr> <tr> <td>Curve</td> <td>7/16</td> </tr> <tr> <td>Diam. (mm)</td> <td>0.14</td> </tr> </tbody> </table>	Suture		Description	Nylon, Black Mono	Length (cm)	15	Size	10-0 (0.2 metric)	Needle		Length (mm)	5.5	Curve	7/16	Diam. (mm)	0.14
Suture																		
Description	Nylon, Black Mono																	
Length (cm)	15																	
Size	10-0 (0.2 metric)																	
Needle																		
Length (mm)	5.5																	
Curve	7/16																	
Diam. (mm)	0.14																	
AB-1406	<p>Nylon Suture, Trape Spatula</p> <p>Double-armed suture, measures 30cm in length. Trape spatula needle, measures 6.0mm in length, 3/8 curve, and 0.14mm in diameter.</p>	 <table border="1"> <thead> <tr> <th colspan="2">Suture</th> </tr> </thead> <tbody> <tr> <td>Description</td> <td>Nylon, Black Mono</td> </tr> <tr> <td>Length (cm)</td> <td>30</td> </tr> <tr> <td>Size</td> <td>10-0 (0.2 metric)</td> </tr> </tbody> </table> <table border="1"> <thead> <tr> <th colspan="2">Needle</th> </tr> </thead> <tbody> <tr> <td>Length (mm)</td> <td>6.0</td> </tr> <tr> <td>Curve</td> <td>3/8</td> </tr> <tr> <td>Diam. (mm)</td> <td>0.14</td> </tr> </tbody> </table>	Suture		Description	Nylon, Black Mono	Length (cm)	30	Size	10-0 (0.2 metric)	Needle		Length (mm)	6.0	Curve	3/8	Diam. (mm)	0.14
Suture																		
Description	Nylon, Black Mono																	
Length (cm)	30																	
Size	10-0 (0.2 metric)																	
Needle																		
Length (mm)	6.0																	
Curve	3/8																	
Diam. (mm)	0.14																	

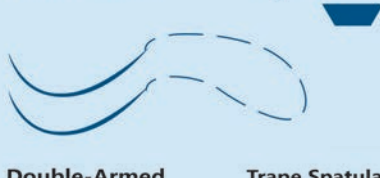
NYLON

Item #	Description	Image																
AB-I406S	<p>Nylon Suture, Trape Spatula</p> <p>Single-armed suture, measures 15cm in length. Trape spatula needle, measures 6.0mm in length, 3/8 curve, and 0.14mm in diameter.</p>	<p>Single-Armed Trape Spatula</p>  <table border="1"> <thead> <tr> <th colspan="2">Suture</th> </tr> </thead> <tbody> <tr> <td>Description</td> <td>Nylon, Black Mono</td> </tr> <tr> <td>Length (cm)</td> <td>15</td> </tr> <tr> <td>Size</td> <td>10-0 (0.2 metric)</td> </tr> </tbody> </table> <table border="1"> <thead> <tr> <th colspan="2">Needle</th> </tr> </thead> <tbody> <tr> <td>Length (mm)</td> <td>6.0</td> </tr> <tr> <td>Curve</td> <td>3/8</td> </tr> <tr> <td>Diam. (mm)</td> <td>0.14</td> </tr> </tbody> </table>	Suture		Description	Nylon, Black Mono	Length (cm)	15	Size	10-0 (0.2 metric)	Needle		Length (mm)	6.0	Curve	3/8	Diam. (mm)	0.14
Suture																		
Description	Nylon, Black Mono																	
Length (cm)	15																	
Size	10-0 (0.2 metric)																	
Needle																		
Length (mm)	6.0																	
Curve	3/8																	
Diam. (mm)	0.14																	
AB-I410	<p>Nylon Suture, Trape Spatula</p> <p>Double-armed suture, measures 30cm in length. Trape spatula needle, measures 7.0mm in length, 1/2 curve, and 0.14mm in diameter.</p>	<p>Double-Armed Trape Spatula</p>  <table border="1"> <thead> <tr> <th colspan="2">Suture</th> </tr> </thead> <tbody> <tr> <td>Description</td> <td>Nylon, Black Mono</td> </tr> <tr> <td>Length (cm)</td> <td>30</td> </tr> <tr> <td>Size</td> <td>10-0 (0.2 metric)</td> </tr> </tbody> </table> <table border="1"> <thead> <tr> <th colspan="2">Needle</th> </tr> </thead> <tbody> <tr> <td>Length (mm)</td> <td>7.0</td> </tr> <tr> <td>Curve</td> <td>1/2</td> </tr> <tr> <td>Diam. (mm)</td> <td>0.14</td> </tr> </tbody> </table>	Suture		Description	Nylon, Black Mono	Length (cm)	30	Size	10-0 (0.2 metric)	Needle		Length (mm)	7.0	Curve	1/2	Diam. (mm)	0.14
Suture																		
Description	Nylon, Black Mono																	
Length (cm)	30																	
Size	10-0 (0.2 metric)																	
Needle																		
Length (mm)	7.0																	
Curve	1/2																	
Diam. (mm)	0.14																	
AB-I410S	<p>Nylon Suture, Trape Spatula</p> <p>Single armed suture, measures 15cm in length. Trape spatula needle, measures 7.0mm in length, 1/2 curve, and 0.14mm in diameter.</p>	<p>Single-Armed Trape Spatula</p>  <table border="1"> <thead> <tr> <th colspan="2">Suture</th> </tr> </thead> <tbody> <tr> <td>Description</td> <td>Nylon, Black Mono</td> </tr> <tr> <td>Length (cm)</td> <td>15</td> </tr> <tr> <td>Size</td> <td>10-0 (0.2 metric)</td> </tr> </tbody> </table> <table border="1"> <thead> <tr> <th colspan="2">Needle</th> </tr> </thead> <tbody> <tr> <td>Length (mm)</td> <td>7.0</td> </tr> <tr> <td>Curve</td> <td>1/2</td> </tr> <tr> <td>Diam. (mm)</td> <td>0.14</td> </tr> </tbody> </table>	Suture		Description	Nylon, Black Mono	Length (cm)	15	Size	10-0 (0.2 metric)	Needle		Length (mm)	7.0	Curve	1/2	Diam. (mm)	0.14
Suture																		
Description	Nylon, Black Mono																	
Length (cm)	15																	
Size	10-0 (0.2 metric)																	
Needle																		
Length (mm)	7.0																	
Curve	1/2																	
Diam. (mm)	0.14																	
AB-I452	<p>Nylon Suture, Trape Spatula</p> <p>Double-armed suture, measures 15cm in length. Trape spatula needle, measures 6.0mm in length, 3/8 curve, and 0.14mm in diameter.</p>	<p>Double-Armed Trape Spatula</p>  <table border="1"> <thead> <tr> <th colspan="2">Suture</th> </tr> </thead> <tbody> <tr> <td>Description</td> <td>Nylon, Black Mono</td> </tr> <tr> <td>Length (cm)</td> <td>15</td> </tr> <tr> <td>Size</td> <td>10-0 (0.2 metric)</td> </tr> </tbody> </table> <table border="1"> <thead> <tr> <th colspan="2">Needle</th> </tr> </thead> <tbody> <tr> <td>Length (mm)</td> <td>6.0</td> </tr> <tr> <td>Curve</td> <td>3/8</td> </tr> <tr> <td>Diam. (mm)</td> <td>0.14</td> </tr> </tbody> </table>	Suture		Description	Nylon, Black Mono	Length (cm)	15	Size	10-0 (0.2 metric)	Needle		Length (mm)	6.0	Curve	3/8	Diam. (mm)	0.14
Suture																		
Description	Nylon, Black Mono																	
Length (cm)	15																	
Size	10-0 (0.2 metric)																	
Needle																		
Length (mm)	6.0																	
Curve	3/8																	
Diam. (mm)	0.14																	
AB-I459	<p>Nylon Suture, Taper Point</p> <p>Double-armed suture, measures 45cm in length. Taper point needle, measures 6.0mm in length, 3/8 curve, and 0.14mm in diameter.</p>	<p>Double-Armed Taper Point</p>  <table border="1"> <thead> <tr> <th colspan="2">Suture</th> </tr> </thead> <tbody> <tr> <td>Description</td> <td>Nylon, Black Mono</td> </tr> <tr> <td>Length (cm)</td> <td>45</td> </tr> <tr> <td>Size</td> <td>10-0 (0.2 metric)</td> </tr> </tbody> </table> <table border="1"> <thead> <tr> <th colspan="2">Needle</th> </tr> </thead> <tbody> <tr> <td>Length (mm)</td> <td>6.0</td> </tr> <tr> <td>Curve</td> <td>3/8</td> </tr> <tr> <td>Diam. (mm)</td> <td>0.14</td> </tr> </tbody> </table>	Suture		Description	Nylon, Black Mono	Length (cm)	45	Size	10-0 (0.2 metric)	Needle		Length (mm)	6.0	Curve	3/8	Diam. (mm)	0.14
Suture																		
Description	Nylon, Black Mono																	
Length (cm)	45																	
Size	10-0 (0.2 metric)																	
Needle																		
Length (mm)	6.0																	
Curve	3/8																	
Diam. (mm)	0.14																	
AB-I468S	<p>Nylon Suture, Trape Spatula</p> <p>Single-armed suture, measures 6cm in length. Trape spatula needle, measures 6.0mm in length, 3/8 curve, and 0.14mm in diameter.</p>	<p>Single-Armed Trape Spatula</p>  <table border="1"> <thead> <tr> <th colspan="2">Suture</th> </tr> </thead> <tbody> <tr> <td>Description</td> <td>Nylon, Black Mono</td> </tr> <tr> <td>Length (cm)</td> <td>6</td> </tr> <tr> <td>Size</td> <td>10-0 (0.2 metric)</td> </tr> </tbody> </table> <table border="1"> <thead> <tr> <th colspan="2">Needle</th> </tr> </thead> <tbody> <tr> <td>Length (mm)</td> <td>6.0</td> </tr> <tr> <td>Curve</td> <td>3/8</td> </tr> <tr> <td>Diam. (mm)</td> <td>0.14</td> </tr> </tbody> </table>	Suture		Description	Nylon, Black Mono	Length (cm)	6	Size	10-0 (0.2 metric)	Needle		Length (mm)	6.0	Curve	3/8	Diam. (mm)	0.14
Suture																		
Description	Nylon, Black Mono																	
Length (cm)	6																	
Size	10-0 (0.2 metric)																	
Needle																		
Length (mm)	6.0																	
Curve	3/8																	
Diam. (mm)	0.14																	
AB-I474	<p>Nylon Suture, Trape Spatula</p> <p>Double-armed suture, measures 20cm in length. Trape spatula needle, measures 5.0mm in length, bi-curve, and 0.14mm in diameter.</p>	<p>Double-Armed Trape Spatula</p>  <table border="1"> <thead> <tr> <th colspan="2">Suture</th> </tr> </thead> <tbody> <tr> <td>Description</td> <td>Nylon, Black Mono</td> </tr> <tr> <td>Length (cm)</td> <td>20</td> </tr> <tr> <td>Size</td> <td>10-0 (0.2 metric)</td> </tr> </tbody> </table> <table border="1"> <thead> <tr> <th colspan="2">Needle</th> </tr> </thead> <tbody> <tr> <td>Length (mm)</td> <td>5.0</td> </tr> <tr> <td>Curve</td> <td>Bi-curve</td> </tr> <tr> <td>Diam. (mm)</td> <td>0.14</td> </tr> </tbody> </table>	Suture		Description	Nylon, Black Mono	Length (cm)	20	Size	10-0 (0.2 metric)	Needle		Length (mm)	5.0	Curve	Bi-curve	Diam. (mm)	0.14
Suture																		
Description	Nylon, Black Mono																	
Length (cm)	20																	
Size	10-0 (0.2 metric)																	
Needle																		
Length (mm)	5.0																	
Curve	Bi-curve																	
Diam. (mm)	0.14																	
AB-I482	<p>Nylon Suture, Trape Spatula</p> <p>Double-armed suture, measures 15cm in length. Trape spatula needle, measures 5.5mm in length, 7/16 curve, and 0.14mm in diameter.</p>	<p>Double-Armed Trape Spatula</p>  <table border="1"> <thead> <tr> <th colspan="2">Suture</th> </tr> </thead> <tbody> <tr> <td>Description</td> <td>Nylon, Black Mono</td> </tr> <tr> <td>Length (cm)</td> <td>15</td> </tr> <tr> <td>Size</td> <td>10-0 (0.2 metric)</td> </tr> </tbody> </table> <table border="1"> <thead> <tr> <th colspan="2">Needle</th> </tr> </thead> <tbody> <tr> <td>Length (mm)</td> <td>5.5</td> </tr> <tr> <td>Curve</td> <td>7/16</td> </tr> <tr> <td>Diam. (mm)</td> <td>0.14</td> </tr> </tbody> </table>	Suture		Description	Nylon, Black Mono	Length (cm)	15	Size	10-0 (0.2 metric)	Needle		Length (mm)	5.5	Curve	7/16	Diam. (mm)	0.14
Suture																		
Description	Nylon, Black Mono																	
Length (cm)	15																	
Size	10-0 (0.2 metric)																	
Needle																		
Length (mm)	5.5																	
Curve	7/16																	
Diam. (mm)	0.14																	

NYLON

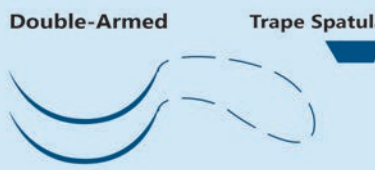
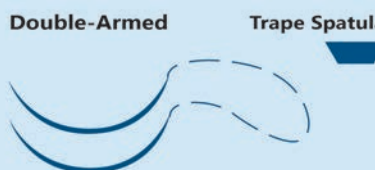
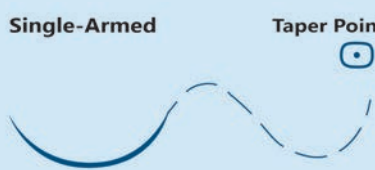
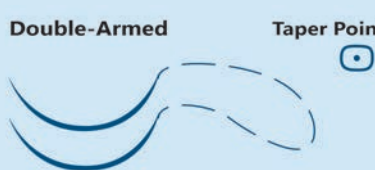
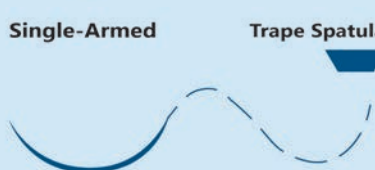
Item #	Description	Image																
AB-2000	Nylon Suture, Trape Spatula Double-armed suture, measures 30cm in length. Trape spatula needle, measures 5.5mm in length, 7/16 curve, and 0.20mm in diameter.	 <table border="1"> <thead> <tr> <th colspan="2">Suture</th> </tr> </thead> <tbody> <tr> <td>Description</td> <td>Nylon, Black Mono</td> </tr> <tr> <td>Length (cm)</td> <td>30</td> </tr> <tr> <td>Size</td> <td>10-0 (0.2 metric)</td> </tr> </tbody> </table> <table border="1"> <thead> <tr> <th colspan="2">Needle</th> </tr> </thead> <tbody> <tr> <td>Length (mm)</td> <td>5.5</td> </tr> <tr> <td>Curve</td> <td>7/16</td> </tr> <tr> <td>Diam. (mm)</td> <td>0.20</td> </tr> </tbody> </table>	Suture		Description	Nylon, Black Mono	Length (cm)	30	Size	10-0 (0.2 metric)	Needle		Length (mm)	5.5	Curve	7/16	Diam. (mm)	0.20
Suture																		
Description	Nylon, Black Mono																	
Length (cm)	30																	
Size	10-0 (0.2 metric)																	
Needle																		
Length (mm)	5.5																	
Curve	7/16																	
Diam. (mm)	0.20																	
AB-2002	Nylon Suture, Trape Spatula Double-armed suture, measures 30cm in length. Trape spatula needle, measures 6.5mm in length, 3/8 curve, and 0.20mm in diameter.	 <table border="1"> <thead> <tr> <th colspan="2">Suture</th> </tr> </thead> <tbody> <tr> <td>Description</td> <td>Nylon, Black Mono</td> </tr> <tr> <td>Length (cm)</td> <td>30</td> </tr> <tr> <td>Size</td> <td>10-0 (0.2 metric)</td> </tr> </tbody> </table> <table border="1"> <thead> <tr> <th colspan="2">Needle</th> </tr> </thead> <tbody> <tr> <td>Length (mm)</td> <td>6.5</td> </tr> <tr> <td>Curve</td> <td>3/8</td> </tr> <tr> <td>Diam. (mm)</td> <td>0.20</td> </tr> </tbody> </table>	Suture		Description	Nylon, Black Mono	Length (cm)	30	Size	10-0 (0.2 metric)	Needle		Length (mm)	6.5	Curve	3/8	Diam. (mm)	0.20
Suture																		
Description	Nylon, Black Mono																	
Length (cm)	30																	
Size	10-0 (0.2 metric)																	
Needle																		
Length (mm)	6.5																	
Curve	3/8																	
Diam. (mm)	0.20																	
AB-1053S	Nylon Suture, Taper Point Single-armed suture, measures 20cm in length. Taper point needle, measures 4.0mm in length, 3/8 curve, and 0.10mm in diameter.	 <table border="1"> <thead> <tr> <th colspan="2">Suture</th> </tr> </thead> <tbody> <tr> <td>Description</td> <td>Nylon, Black Mono</td> </tr> <tr> <td>Length (cm)</td> <td>20</td> </tr> <tr> <td>Size</td> <td>10-0 (0.2 metric)</td> </tr> </tbody> </table> <table border="1"> <thead> <tr> <th colspan="2">Needle</th> </tr> </thead> <tbody> <tr> <td>Length (mm)</td> <td>4.0</td> </tr> <tr> <td>Curve</td> <td>3/8</td> </tr> <tr> <td>Diam. (mm)</td> <td>0.10</td> </tr> </tbody> </table>	Suture		Description	Nylon, Black Mono	Length (cm)	20	Size	10-0 (0.2 metric)	Needle		Length (mm)	4.0	Curve	3/8	Diam. (mm)	0.10
Suture																		
Description	Nylon, Black Mono																	
Length (cm)	20																	
Size	10-0 (0.2 metric)																	
Needle																		
Length (mm)	4.0																	
Curve	3/8																	
Diam. (mm)	0.10																	
AB-1475	Nylon Suture, Taper Point Double-armed suture, measures 30cm in length. Taper point needle, measures 5.5mm in length, 7/16 curve, and 0.14mm in diameter.	 <table border="1"> <thead> <tr> <th colspan="2">Suture</th> </tr> </thead> <tbody> <tr> <td>Description</td> <td>Nylon, Black Mono</td> </tr> <tr> <td>Length (cm)</td> <td>30</td> </tr> <tr> <td>Size</td> <td>10-0 (0.2 metric)</td> </tr> </tbody> </table> <table border="1"> <thead> <tr> <th colspan="2">Needle</th> </tr> </thead> <tbody> <tr> <td>Length (mm)</td> <td>5.5</td> </tr> <tr> <td>Curve</td> <td>7/16</td> </tr> <tr> <td>Diam. (mm)</td> <td>0.14</td> </tr> </tbody> </table>	Suture		Description	Nylon, Black Mono	Length (cm)	30	Size	10-0 (0.2 metric)	Needle		Length (mm)	5.5	Curve	7/16	Diam. (mm)	0.14
Suture																		
Description	Nylon, Black Mono																	
Length (cm)	30																	
Size	10-0 (0.2 metric)																	
Needle																		
Length (mm)	5.5																	
Curve	7/16																	
Diam. (mm)	0.14																	
AB-2002S	Nylon Suture, Trape Spatula Single-armed suture, measures 15cm in length. Trape spatula needle, measures 6.5mm in length, 3/8 curve, and 0.20mm in diameter.	 <table border="1"> <thead> <tr> <th colspan="2">Suture</th> </tr> </thead> <tbody> <tr> <td>Description</td> <td>Nylon, Black Mono</td> </tr> <tr> <td>Length (cm)</td> <td>15</td> </tr> <tr> <td>Size</td> <td>10-0 (0.2 metric)</td> </tr> </tbody> </table> <table border="1"> <thead> <tr> <th colspan="2">Needle</th> </tr> </thead> <tbody> <tr> <td>Length (mm)</td> <td>6.5</td> </tr> <tr> <td>Curve</td> <td>3/8</td> </tr> <tr> <td>Diam. (mm)</td> <td>0.20</td> </tr> </tbody> </table>	Suture		Description	Nylon, Black Mono	Length (cm)	15	Size	10-0 (0.2 metric)	Needle		Length (mm)	6.5	Curve	3/8	Diam. (mm)	0.20
Suture																		
Description	Nylon, Black Mono																	
Length (cm)	15																	
Size	10-0 (0.2 metric)																	
Needle																		
Length (mm)	6.5																	
Curve	3/8																	
Diam. (mm)	0.20																	

Sutures 9-0 Nylon

Mani brand 9-0, black mono, nylon sutures with both single and double arms. Trape spatula needles ranging in length, curve, and diameter. Mani sutures are ideal for micro-suturing on the cornea and sclera during eye surgery. Ultimate sharpness is obtained through the "cross-lapped edge" technique giving each suture a fine and sharp tip ensuring minimally invasive wound closure. Mani hard fiber stainless steel is used to make strong and break-resistant needles. Sold 12 per box.

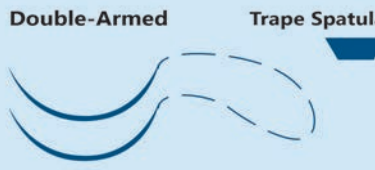
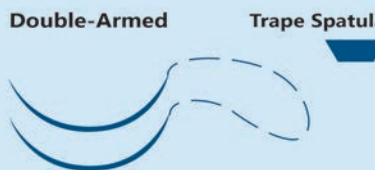
AB-1405	Nylon Suture, Trape Spatula Double-armed suture, measures 30cm in length. Trape spatula needle, measures 5.5mm in length, 7/16 curve, and 0.14mm in diameter.	 <table border="1"> <thead> <tr> <th colspan="2">Suture</th> </tr> </thead> <tbody> <tr> <td>Description</td> <td>Nylon, Black Mono</td> </tr> <tr> <td>Length (cm)</td> <td>30</td> </tr> <tr> <td>Size</td> <td>9-0 (0.3 metric)</td> </tr> </tbody> </table> <table border="1"> <thead> <tr> <th colspan="2">Needle</th> </tr> </thead> <tbody> <tr> <td>Length (mm)</td> <td>5.5</td> </tr> <tr> <td>Curve</td> <td>7/16</td> </tr> <tr> <td>Diam. (mm)</td> <td>0.14</td> </tr> </tbody> </table>	Suture		Description	Nylon, Black Mono	Length (cm)	30	Size	9-0 (0.3 metric)	Needle		Length (mm)	5.5	Curve	7/16	Diam. (mm)	0.14
Suture																		
Description	Nylon, Black Mono																	
Length (cm)	30																	
Size	9-0 (0.3 metric)																	
Needle																		
Length (mm)	5.5																	
Curve	7/16																	
Diam. (mm)	0.14																	
AB-1407	Nylon Suture, Trape Spatula Double-armed suture, measures 30cm in length. Trape spatula needle, measures 6.0mm in length, 3/8 curve, and 0.14mm in diameter.	 <table border="1"> <thead> <tr> <th colspan="2">Suture</th> </tr> </thead> <tbody> <tr> <td>Description</td> <td>Nylon, Black Mono</td> </tr> <tr> <td>Length (cm)</td> <td>30</td> </tr> <tr> <td>Size</td> <td>9-0 (0.3 metric)</td> </tr> </tbody> </table> <table border="1"> <thead> <tr> <th colspan="2">Needle</th> </tr> </thead> <tbody> <tr> <td>Length (mm)</td> <td>6.0</td> </tr> <tr> <td>Curve</td> <td>3/8</td> </tr> <tr> <td>Diam. (mm)</td> <td>0.14</td> </tr> </tbody> </table>	Suture		Description	Nylon, Black Mono	Length (cm)	30	Size	9-0 (0.3 metric)	Needle		Length (mm)	6.0	Curve	3/8	Diam. (mm)	0.14
Suture																		
Description	Nylon, Black Mono																	
Length (cm)	30																	
Size	9-0 (0.3 metric)																	
Needle																		
Length (mm)	6.0																	
Curve	3/8																	
Diam. (mm)	0.14																	

NYLON

Item #	Description	Image																
AB-2003	<p>Nylon Suture, Trape Spatula</p> <p>Double-armed suture, measures 30cm in length. Trape spatula needle, measures 6.5mm in length, 3/8 curve, and 0.20mm in diameter.</p>	<table border="1"> <thead> <tr> <th colspan="2">Suture</th> </tr> </thead> <tbody> <tr> <td>Description</td> <td>Nylon, Black Mono</td> </tr> <tr> <td>Length (cm)</td> <td>30</td> </tr> <tr> <td>Size</td> <td>9-0 (0.3 metric)</td> </tr> </tbody> </table> <table border="1"> <thead> <tr> <th colspan="2">Needle</th> </tr> </thead> <tbody> <tr> <td>Length (mm)</td> <td>6.5</td> </tr> <tr> <td>Curve</td> <td>3/8</td> </tr> <tr> <td>Diam. (mm)</td> <td>0.20</td> </tr> </tbody> </table>	Suture		Description	Nylon, Black Mono	Length (cm)	30	Size	9-0 (0.3 metric)	Needle		Length (mm)	6.5	Curve	3/8	Diam. (mm)	0.20
Suture																		
Description	Nylon, Black Mono																	
Length (cm)	30																	
Size	9-0 (0.3 metric)																	
Needle																		
Length (mm)	6.5																	
Curve	3/8																	
Diam. (mm)	0.20																	
AB-1402	<p>Nylon Suture, Trape Spatula</p> <p>Double-armed suture, measures 30cm in length. Trape spatula needle, measures 5.0mm in length, bi-curve, and 0.14mm in diameter.</p>	<table border="1"> <thead> <tr> <th colspan="2">Suture</th> </tr> </thead> <tbody> <tr> <td>Description</td> <td>Nylon, Black Mono</td> </tr> <tr> <td>Length (cm)</td> <td>30</td> </tr> <tr> <td>Size</td> <td>9-0 (0.3 metric)</td> </tr> </tbody> </table> <table border="1"> <thead> <tr> <th colspan="2">Needle</th> </tr> </thead> <tbody> <tr> <td>Length (mm)</td> <td>5.0</td> </tr> <tr> <td>Curve</td> <td>Bi-curve</td> </tr> <tr> <td>Diam. (mm)</td> <td>0.14</td> </tr> </tbody> </table>	Suture		Description	Nylon, Black Mono	Length (cm)	30	Size	9-0 (0.3 metric)	Needle		Length (mm)	5.0	Curve	Bi-curve	Diam. (mm)	0.14
Suture																		
Description	Nylon, Black Mono																	
Length (cm)	30																	
Size	9-0 (0.3 metric)																	
Needle																		
Length (mm)	5.0																	
Curve	Bi-curve																	
Diam. (mm)	0.14																	
AB-1407S	<p>Nylon Suture, Trape Spatula</p> <p>Single-armed suture, measures 15cm in length. Trape spatula needle, measures 6.0mm in length, 3/8 curve, and 0.14mm in diameter.</p>	<table border="1"> <thead> <tr> <th colspan="2">Suture</th> </tr> </thead> <tbody> <tr> <td>Description</td> <td>Nylon, Black Mono</td> </tr> <tr> <td>Length (cm)</td> <td>15</td> </tr> <tr> <td>Size</td> <td>9-0 (0.3 metric)</td> </tr> </tbody> </table> <table border="1"> <thead> <tr> <th colspan="2">Needle</th> </tr> </thead> <tbody> <tr> <td>Length (mm)</td> <td>6.0</td> </tr> <tr> <td>Curve</td> <td>3/8</td> </tr> <tr> <td>Diam. (mm)</td> <td>0.14</td> </tr> </tbody> </table>	Suture		Description	Nylon, Black Mono	Length (cm)	15	Size	9-0 (0.3 metric)	Needle		Length (mm)	6.0	Curve	3/8	Diam. (mm)	0.14
Suture																		
Description	Nylon, Black Mono																	
Length (cm)	15																	
Size	9-0 (0.3 metric)																	
Needle																		
Length (mm)	6.0																	
Curve	3/8																	
Diam. (mm)	0.14																	
AB-2003S	<p>Nylon Suture, Trape Spatula</p> <p>Single-armed suture, measures 15cm in length. Trape spatula needle, measures 6.5mm in length, 3/8 curve, and 0.20mm in diameter.</p>	<table border="1"> <thead> <tr> <th colspan="2">Suture</th> </tr> </thead> <tbody> <tr> <td>Description</td> <td>Nylon, Black Mono</td> </tr> <tr> <td>Length (cm)</td> <td>15</td> </tr> <tr> <td>Size</td> <td>9-0 (0.3 metric)</td> </tr> </tbody> </table> <table border="1"> <thead> <tr> <th colspan="2">Needle</th> </tr> </thead> <tbody> <tr> <td>Length (mm)</td> <td>6.5</td> </tr> <tr> <td>Curve</td> <td>3/8</td> </tr> <tr> <td>Diam. (mm)</td> <td>0.20</td> </tr> </tbody> </table>	Suture		Description	Nylon, Black Mono	Length (cm)	15	Size	9-0 (0.3 metric)	Needle		Length (mm)	6.5	Curve	3/8	Diam. (mm)	0.20
Suture																		
Description	Nylon, Black Mono																	
Length (cm)	15																	
Size	9-0 (0.3 metric)																	
Needle																		
Length (mm)	6.5																	
Curve	3/8																	
Diam. (mm)	0.20																	

Sutures 8-0 Nylon

Mani brand 8-0, black mono, nylon sutures with both single and double arms. Trape spatula and reverse cut needles ranging in length, curve, and diameter. Mani sutures are ideal for micro-suturing on the cornea and sclera during eye surgery. Ultimate sharpness is obtained through the "cross-lapped edge" technique giving each suture a fine and sharp tip ensuring minimally invasive wound closure. Mani hard fiber stainless steel is used to make strong and break-resistant needles. Sold 12 per box.

AB-1421	<p>Nylon Suture, Trape Spatula</p> <p>Double-armed suture, measures 30cm in length. Trape Spatula needle, measures 5.5mm in length, 7/16 curve, and 0.14mm in diameter.</p>	<table border="1"> <thead> <tr> <th colspan="2">Suture</th> </tr> </thead> <tbody> <tr> <td>Description</td> <td>Nylon, Black Mono</td> </tr> <tr> <td>Length (cm)</td> <td>30</td> </tr> <tr> <td>Size</td> <td>8-0 (0.4 metric)</td> </tr> </tbody> </table> <table border="1"> <thead> <tr> <th colspan="2">Needle</th> </tr> </thead> <tbody> <tr> <td>Length (mm)</td> <td>5.5</td> </tr> <tr> <td>Curve</td> <td>7/16</td> </tr> <tr> <td>Diam. (mm)</td> <td>0.14</td> </tr> </tbody> </table>	Suture		Description	Nylon, Black Mono	Length (cm)	30	Size	8-0 (0.4 metric)	Needle		Length (mm)	5.5	Curve	7/16	Diam. (mm)	0.14
Suture																		
Description	Nylon, Black Mono																	
Length (cm)	30																	
Size	8-0 (0.4 metric)																	
Needle																		
Length (mm)	5.5																	
Curve	7/16																	
Diam. (mm)	0.14																	
AB-2028	<p>Nylon Suture, Trape Spatula</p> <p>Double-armed suture, measures 30cm in length. Trape spatula needle, measures 7.0mm in length, 1/2 curve, and 0.20mm in diameter.</p>	<table border="1"> <thead> <tr> <th colspan="2">Suture</th> </tr> </thead> <tbody> <tr> <td>Description</td> <td>Nylon, Black Mono</td> </tr> <tr> <td>Length (cm)</td> <td>30</td> </tr> <tr> <td>Size</td> <td>8-0 (0.4 metric)</td> </tr> </tbody> </table> <table border="1"> <thead> <tr> <th colspan="2">Needle</th> </tr> </thead> <tbody> <tr> <td>Length (mm)</td> <td>7.0</td> </tr> <tr> <td>Curve</td> <td>1/2</td> </tr> <tr> <td>Diam. (mm)</td> <td>0.20</td> </tr> </tbody> </table>	Suture		Description	Nylon, Black Mono	Length (cm)	30	Size	8-0 (0.4 metric)	Needle		Length (mm)	7.0	Curve	1/2	Diam. (mm)	0.20
Suture																		
Description	Nylon, Black Mono																	
Length (cm)	30																	
Size	8-0 (0.4 metric)																	
Needle																		
Length (mm)	7.0																	
Curve	1/2																	
Diam. (mm)	0.20																	
AB-2054	<p>Nylon Suture, Trape Spatula</p> <p>Double-armed suture, measures 30cm in length. Trape spatula needle, measures 6.5mm in length, 1/4 curve, and 0.20mm in diameter.</p>	<table border="1"> <thead> <tr> <th colspan="2">Suture</th> </tr> </thead> <tbody> <tr> <td>Description</td> <td>Nylon, Black Mono</td> </tr> <tr> <td>Length (cm)</td> <td>30</td> </tr> <tr> <td>Size</td> <td>8-0 (0.4 metric)</td> </tr> </tbody> </table> <table border="1"> <thead> <tr> <th colspan="2">Needle</th> </tr> </thead> <tbody> <tr> <td>Length (mm)</td> <td>6.5</td> </tr> <tr> <td>Curve</td> <td>1/4</td> </tr> <tr> <td>Diam. (mm)</td> <td>0.20</td> </tr> </tbody> </table>	Suture		Description	Nylon, Black Mono	Length (cm)	30	Size	8-0 (0.4 metric)	Needle		Length (mm)	6.5	Curve	1/4	Diam. (mm)	0.20
Suture																		
Description	Nylon, Black Mono																	
Length (cm)	30																	
Size	8-0 (0.4 metric)																	
Needle																		
Length (mm)	6.5																	
Curve	1/4																	
Diam. (mm)	0.20																	

NYLON

Item #	Description	Image	Suture	Needle												
AB-2056	Nylon Suture, Trape Spatula Double-armed suture, measures 30cm in length. Trape spatula needle, measures 6.5mm in length, 3/8 curve, and 0.20mm in diameter.		<table border="1"> <tr><td>Description</td><td>Nylon, Black Mono</td></tr> <tr><td>Length (cm)</td><td>30</td></tr> <tr><td>Size</td><td>8-0 (0.4 metric)</td></tr> </table>	Description	Nylon, Black Mono	Length (cm)	30	Size	8-0 (0.4 metric)	<table border="1"> <tr><td>Length (mm)</td><td>6.5</td></tr> <tr><td>Curve</td><td>3/8</td></tr> <tr><td>Diam. (mm)</td><td>0.20</td></tr> </table>	Length (mm)	6.5	Curve	3/8	Diam. (mm)	0.20
Description	Nylon, Black Mono															
Length (cm)	30															
Size	8-0 (0.4 metric)															
Length (mm)	6.5															
Curve	3/8															
Diam. (mm)	0.20															
AB-2461S	Nylon Suture, Reverse Cut Single-armed suture, measures 50cm in length. Reverse cut needle, measures 11.0mm in length, 3/8 curve, and 0.24mm in diameter.		<table border="1"> <tr><td>Description</td><td>Nylon, Black Mono</td></tr> <tr><td>Length (cm)</td><td>50</td></tr> <tr><td>Size</td><td>8-0 (0.4 metric)</td></tr> </table>	Description	Nylon, Black Mono	Length (cm)	50	Size	8-0 (0.4 metric)	<table border="1"> <tr><td>Length (mm)</td><td>11.0</td></tr> <tr><td>Curve</td><td>3/8</td></tr> <tr><td>Diam. (mm)</td><td>0.24</td></tr> </table>	Length (mm)	11.0	Curve	3/8	Diam. (mm)	0.24
Description	Nylon, Black Mono															
Length (cm)	50															
Size	8-0 (0.4 metric)															
Length (mm)	11.0															
Curve	3/8															
Diam. (mm)	0.24															
AB-2461	Nylon Suture, Reverse Cut Double-armed suture, measures 50cm in length. Reverse cut needle, measures 11.0mm in length, 3/8 curve, and 0.24mm in diameter.		<table border="1"> <tr><td>Description</td><td>Nylon, Black Mono</td></tr> <tr><td>Length (cm)</td><td>50</td></tr> <tr><td>Size</td><td>8-0 (0.4 metric)</td></tr> </table>	Description	Nylon, Black Mono	Length (cm)	50	Size	8-0 (0.4 metric)	<table border="1"> <tr><td>Length (mm)</td><td>11.0</td></tr> <tr><td>Curve</td><td>3/8</td></tr> <tr><td>Diam. (mm)</td><td>0.24</td></tr> </table>	Length (mm)	11.0	Curve	3/8	Diam. (mm)	0.24
Description	Nylon, Black Mono															
Length (cm)	50															
Size	8-0 (0.4 metric)															
Length (mm)	11.0															
Curve	3/8															
Diam. (mm)	0.24															

Sutures 7-0 Nylon

Mani brand 7-0, black mono, nylon sutures with both single and double arms. Trape spatula, lancet, cut taper, and reverse cut needles ranging in length, curve, and diameter. Mani sutures are ideal for micro-suturing on the cornea and sclera during eye surgery. Ultimate sharpness is obtained through the "cross-lapped edge" technique giving each suture a fine and sharp tip ensuring minimally invasive wound closure. Mani hard fiber stainless steel is used to make strong and break-resistant needles. Sold 12 per box.

AB-2058	Nylon Suture, Trape Spatula Double-armed suture, measures 30cm in length. Trape spatula needle, measures 6.5mm in length, 3/8 curve, and 0.20mm in diameter.		<table border="1"> <tr><td>Description</td><td>Nylon, Black Mono</td></tr> <tr><td>Length (cm)</td><td>30</td></tr> <tr><td>Size</td><td>7-0 (0.5 metric)</td></tr> </table>	Description	Nylon, Black Mono	Length (cm)	30	Size	7-0 (0.5 metric)	<table border="1"> <tr><td>Length (mm)</td><td>6.5</td></tr> <tr><td>Curve</td><td>3/8</td></tr> <tr><td>Diam. (mm)</td><td>0.20</td></tr> </table>	Length (mm)	6.5	Curve	3/8	Diam. (mm)	0.20
Description	Nylon, Black Mono															
Length (cm)	30															
Size	7-0 (0.5 metric)															
Length (mm)	6.5															
Curve	3/8															
Diam. (mm)	0.20															
AB-3365	Nylon Suture, Cut Taper Double-armed suture, measures 30cm in length. Cut taper needle, measures 15.0mm in length, 3/8 curve, and 0.33mm in diameter.		<table border="1"> <tr><td>Description</td><td>Nylon, Black Mono</td></tr> <tr><td>Length (cm)</td><td>30</td></tr> <tr><td>Size</td><td>7-0 (0.5 metric)</td></tr> </table>	Description	Nylon, Black Mono	Length (cm)	30	Size	7-0 (0.5 metric)	<table border="1"> <tr><td>Length (mm)</td><td>15.0</td></tr> <tr><td>Curve</td><td>3/8</td></tr> <tr><td>Diam. (mm)</td><td>0.33</td></tr> </table>	Length (mm)	15.0	Curve	3/8	Diam. (mm)	0.33
Description	Nylon, Black Mono															
Length (cm)	30															
Size	7-0 (0.5 metric)															
Length (mm)	15.0															
Curve	3/8															
Diam. (mm)	0.33															
AB-2455S	Nylon Suture, Reverse Cut Single-armed suture, measures 45cm in length. Reverse cut needle, measures 7.0mm in length, 3/8 curve, and 0.24mm in diameter.		<table border="1"> <tr><td>Description</td><td>Nylon, Black Mono</td></tr> <tr><td>Length (cm)</td><td>45</td></tr> <tr><td>Size</td><td>7-0 (0.5 metric)</td></tr> </table>	Description	Nylon, Black Mono	Length (cm)	45	Size	7-0 (0.5 metric)	<table border="1"> <tr><td>Length (mm)</td><td>7.0</td></tr> <tr><td>Curve</td><td>3/8</td></tr> <tr><td>Diam. (mm)</td><td>0.24</td></tr> </table>	Length (mm)	7.0	Curve	3/8	Diam. (mm)	0.24
Description	Nylon, Black Mono															
Length (cm)	45															
Size	7-0 (0.5 metric)															
Length (mm)	7.0															
Curve	3/8															
Diam. (mm)	0.24															
AB-2457S	Nylon Suture, Reverse Cut Single-armed suture, measures 50cm in length. Reverse cut needle, measures 9.0mm in length, 3/8 curve, and 0.24mm in diameter.		<table border="1"> <tr><td>Description</td><td>Nylon, Black Mono</td></tr> <tr><td>Length (cm)</td><td>50</td></tr> <tr><td>Size</td><td>7-0 (0.5 metric)</td></tr> </table>	Description	Nylon, Black Mono	Length (cm)	50	Size	7-0 (0.5 metric)	<table border="1"> <tr><td>Length (mm)</td><td>9.0</td></tr> <tr><td>Curve</td><td>3/8</td></tr> <tr><td>Diam. (mm)</td><td>0.24</td></tr> </table>	Length (mm)	9.0	Curve	3/8	Diam. (mm)	0.24
Description	Nylon, Black Mono															
Length (cm)	50															
Size	7-0 (0.5 metric)															
Length (mm)	9.0															
Curve	3/8															
Diam. (mm)	0.24															

NYLON

Item #	Description	Image																
AB-2463	<p>Nylon Suture, Reverse Cut</p> <p>Double-armed suture, measures 30cm in length. Reverse cut needle, measures 11.0mm in length, 3/8 curve, and 0.24mm in diameter.</p>	<p>Double-Armed Reverse Cut</p> <table border="1"> <thead> <tr> <th colspan="2">Suture</th> </tr> </thead> <tbody> <tr> <td>Description</td> <td>Nylon, Black Mono</td> </tr> <tr> <td>Length (cm)</td> <td>30</td> </tr> <tr> <td>Size</td> <td>7-0 (0.5 metric)</td> </tr> </tbody> </table> <table border="1"> <thead> <tr> <th colspan="2">Needle</th> </tr> </thead> <tbody> <tr> <td>Length (mm)</td> <td>11.0</td> </tr> <tr> <td>Curve</td> <td>3/8</td> </tr> <tr> <td>Diam. (mm)</td> <td>0.24</td> </tr> </tbody> </table>	Suture		Description	Nylon, Black Mono	Length (cm)	30	Size	7-0 (0.5 metric)	Needle		Length (mm)	11.0	Curve	3/8	Diam. (mm)	0.24
Suture																		
Description	Nylon, Black Mono																	
Length (cm)	30																	
Size	7-0 (0.5 metric)																	
Needle																		
Length (mm)	11.0																	
Curve	3/8																	
Diam. (mm)	0.24																	
AB-2855	<p>Nylon Suture, Trape Spatula</p> <p>Double-armed suture, measures 45cm in length. Trape spatula needle, measures 8.0mm in length, 3/8 curve, and 0.28mm in diameter.</p>	<p>Double-Armed Trape Spatula</p> <table border="1"> <thead> <tr> <th colspan="2">Suture</th> </tr> </thead> <tbody> <tr> <td>Description</td> <td>Nylon, Black Mono</td> </tr> <tr> <td>Length (cm)</td> <td>45</td> </tr> <tr> <td>Size</td> <td>7-0 (0.5 metric)</td> </tr> </tbody> </table> <table border="1"> <thead> <tr> <th colspan="2">Needle</th> </tr> </thead> <tbody> <tr> <td>Length (mm)</td> <td>8.0</td> </tr> <tr> <td>Curve</td> <td>3/8</td> </tr> <tr> <td>Diam. (mm)</td> <td>0.28</td> </tr> </tbody> </table>	Suture		Description	Nylon, Black Mono	Length (cm)	45	Size	7-0 (0.5 metric)	Needle		Length (mm)	8.0	Curve	3/8	Diam. (mm)	0.28
Suture																		
Description	Nylon, Black Mono																	
Length (cm)	45																	
Size	7-0 (0.5 metric)																	
Needle																		
Length (mm)	8.0																	
Curve	3/8																	
Diam. (mm)	0.28																	
AB-3364S	<p>Nylon Suture, Lancet</p> <p>Single-armed suture, measures 50cm in length. Lancet needle, measures 11.0mm in length, 3/8 curve, and 0.33mm in diameter.</p>	<p>Single-Armed Lancet</p> <table border="1"> <thead> <tr> <th colspan="2">Suture</th> </tr> </thead> <tbody> <tr> <td>Description</td> <td>Nylon, Black Mono</td> </tr> <tr> <td>Length (cm)</td> <td>50</td> </tr> <tr> <td>Size</td> <td>7-0 (0.5 metric)</td> </tr> </tbody> </table> <table border="1"> <thead> <tr> <th colspan="2">Needle</th> </tr> </thead> <tbody> <tr> <td>Length (mm)</td> <td>11.0</td> </tr> <tr> <td>Curve</td> <td>3/8</td> </tr> <tr> <td>Diam. (mm)</td> <td>0.33</td> </tr> </tbody> </table>	Suture		Description	Nylon, Black Mono	Length (cm)	50	Size	7-0 (0.5 metric)	Needle		Length (mm)	11.0	Curve	3/8	Diam. (mm)	0.33
Suture																		
Description	Nylon, Black Mono																	
Length (cm)	50																	
Size	7-0 (0.5 metric)																	
Needle																		
Length (mm)	11.0																	
Curve	3/8																	
Diam. (mm)	0.33																	
AB-1457	<p>Nylon Suture, Trape Spatula</p> <p>Double-armed suture, measures 30cm in length. Trape spatula needle, measures 5.5mm in length, 7/16 curve, and 0.14mm in diameter.</p>	<p>Double-Armed Trape Spatula</p> <table border="1"> <thead> <tr> <th colspan="2">Suture</th> </tr> </thead> <tbody> <tr> <td>Description</td> <td>Nylon, Black Mono</td> </tr> <tr> <td>Length (cm)</td> <td>30</td> </tr> <tr> <td>Size</td> <td>7-0 (0.5 metric)</td> </tr> </tbody> </table> <table border="1"> <thead> <tr> <th colspan="2">Needle</th> </tr> </thead> <tbody> <tr> <td>Length (mm)</td> <td>5.5</td> </tr> <tr> <td>Curve</td> <td>7/16</td> </tr> <tr> <td>Diam. (mm)</td> <td>0.14</td> </tr> </tbody> </table>	Suture		Description	Nylon, Black Mono	Length (cm)	30	Size	7-0 (0.5 metric)	Needle		Length (mm)	5.5	Curve	7/16	Diam. (mm)	0.14
Suture																		
Description	Nylon, Black Mono																	
Length (cm)	30																	
Size	7-0 (0.5 metric)																	
Needle																		
Length (mm)	5.5																	
Curve	7/16																	
Diam. (mm)	0.14																	
AB-3361	<p>Nylon Suture, Lancet</p> <p>Double-armed suture, measures 30cm in length. Lancet needle, measures 8.0mm in length, 3/8 curve, and 0.33mm in diameter.</p>	<p>Double-Armed Lancet</p> <table border="1"> <thead> <tr> <th colspan="2">Suture</th> </tr> </thead> <tbody> <tr> <td>Description</td> <td>Nylon, Black Mono</td> </tr> <tr> <td>Length (cm)</td> <td>30</td> </tr> <tr> <td>Size</td> <td>7-0 (0.5 metric)</td> </tr> </tbody> </table> <table border="1"> <thead> <tr> <th colspan="2">Needle</th> </tr> </thead> <tbody> <tr> <td>Length (mm)</td> <td>8.0</td> </tr> <tr> <td>Curve</td> <td>3/8</td> </tr> <tr> <td>Diam. (mm)</td> <td>0.33</td> </tr> </tbody> </table>	Suture		Description	Nylon, Black Mono	Length (cm)	30	Size	7-0 (0.5 metric)	Needle		Length (mm)	8.0	Curve	3/8	Diam. (mm)	0.33
Suture																		
Description	Nylon, Black Mono																	
Length (cm)	30																	
Size	7-0 (0.5 metric)																	
Needle																		
Length (mm)	8.0																	
Curve	3/8																	
Diam. (mm)	0.33																	
AB-3361S	<p>Nylon Suture, Lancet</p> <p>Single-armed suture, measures 45cm in length. Lancet needle, measures 8.0mm in length, 3/8 curve, and 0.33mm in diameter.</p>	<p>Single-Armed Lancet</p> <table border="1"> <thead> <tr> <th colspan="2">Suture</th> </tr> </thead> <tbody> <tr> <td>Description</td> <td>Nylon, Black Mono</td> </tr> <tr> <td>Length (cm)</td> <td>45</td> </tr> <tr> <td>Size</td> <td>7-0 (0.5 metric)</td> </tr> </tbody> </table> <table border="1"> <thead> <tr> <th colspan="2">Needle</th> </tr> </thead> <tbody> <tr> <td>Length (mm)</td> <td>8.0</td> </tr> <tr> <td>Curve</td> <td>3/8</td> </tr> <tr> <td>Diam. (mm)</td> <td>0.33</td> </tr> </tbody> </table>	Suture		Description	Nylon, Black Mono	Length (cm)	45	Size	7-0 (0.5 metric)	Needle		Length (mm)	8.0	Curve	3/8	Diam. (mm)	0.33
Suture																		
Description	Nylon, Black Mono																	
Length (cm)	45																	
Size	7-0 (0.5 metric)																	
Needle																		
Length (mm)	8.0																	
Curve	3/8																	
Diam. (mm)	0.33																	
AB-3364	<p>Nylon Suture, Lancet</p> <p>Double-armed suture, measures 50cm in length. Lancet needle, measures 11.0mm in length, 3/8 curve, and 0.33mm in diameter.</p>	<p>Double-Armed Lancet</p> <table border="1"> <thead> <tr> <th colspan="2">Suture</th> </tr> </thead> <tbody> <tr> <td>Description</td> <td>Nylon, Black Mono</td> </tr> <tr> <td>Length (cm)</td> <td>50</td> </tr> <tr> <td>Size</td> <td>7-0 (0.5 metric)</td> </tr> </tbody> </table> <table border="1"> <thead> <tr> <th colspan="2">Needle</th> </tr> </thead> <tbody> <tr> <td>Length (mm)</td> <td>11.0</td> </tr> <tr> <td>Curve</td> <td>3/8</td> </tr> <tr> <td>Diam. (mm)</td> <td>0.33</td> </tr> </tbody> </table>	Suture		Description	Nylon, Black Mono	Length (cm)	50	Size	7-0 (0.5 metric)	Needle		Length (mm)	11.0	Curve	3/8	Diam. (mm)	0.33
Suture																		
Description	Nylon, Black Mono																	
Length (cm)	50																	
Size	7-0 (0.5 metric)																	
Needle																		
Length (mm)	11.0																	
Curve	3/8																	
Diam. (mm)	0.33																	

NYLON

Item # **Description** **Image**

Sutures 6-0 Nylon

Mani brand 6-0, black mono, nylon sutures with both single and double arms. Trape spatula, lancet, cut taper, and reverse cut needles ranging in length, curve, and diameter. Mani sutures are ideal for micro-suturing on the cornea and sclera during eye surgery. Ultimate sharpness is obtained through the "cross-lapped edge" technique giving each suture a fine and sharp tip ensuring minimally invasive wound closure. Mani hard fiber stainless steel is used to make strong and break-resistant needles. Sold 12 per box.

AB-2808 **Nylon Suture, Reverse Cut**
 Double-armed suture, measures 30cm in length. Reverse cut needle, measures 13.0mm in length, 3/8 curve, and 0.28mm in diameter.

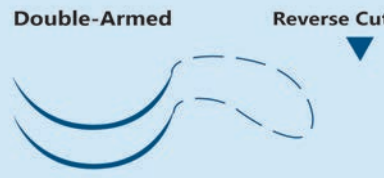

Suture	
Description	Nylon, Black Mono
Length (cm)	30
Size	6-0 (0.7 metric)

Needle	
Length (mm)	13.0
Curve	3/8
Diam. (mm)	0.28

AB-2808S **Nylon Suture, Reverse Cut**
 Single-armed suture, measures 20cm in length. Reverse cut needle, measures 13.0mm in length, 3/8 curve, and 0.28mm in diameter.

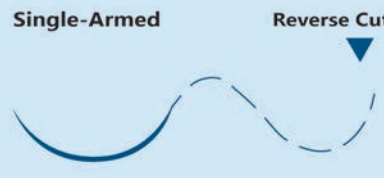

Suture	
Description	Nylon, Black Mono
Length (cm)	20
Size	6-0 (0.7 metric)

Needle	
Length (mm)	13.0
Curve	3/8
Diam. (mm)	0.28

AB-2854 **Nylon Suture, Trape Spatula**
 Double-armed suture, measures 45cm in length. Trape spatula needle, measures 8.0mm in length, 3/8 curve, and 0.28mm in diameter.

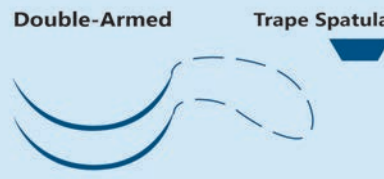

Suture	
Description	Nylon, Black Mono
Length (cm)	45
Size	6-0 (0.7 metric)

Needle	
Length (mm)	8.0
Curve	3/8
Diam. (mm)	0.28

AB-3363S **Nylon Suture, Lancet**
 Single-armed suture, measures 45cm in length. Lancet needle, measures 13.0mm in length, 1/2 curve, and 0.33mm in diameter.

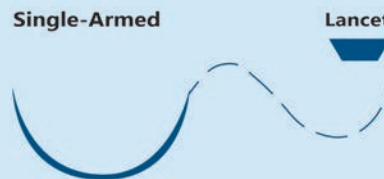

Suture	
Description	Nylon, Black Mono
Length (cm)	45
Size	6-0 (0.7 metric)

Needle	
Length (mm)	13.0
Curve	1/2
Diam. (mm)	0.33

AB-3379S **Nylon Suture, Lancet**
 Single-armed suture, measures 30cm in length. Lancet needle, measures 7.0mm in length, 3/8 curve, and 0.33mm in diameter.

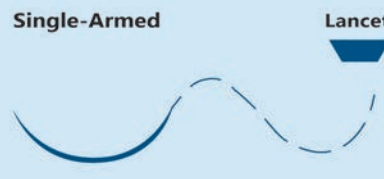

Suture	
Description	Nylon, Black Mono
Length (cm)	30
Size	6-0 (0.7 metric)

Needle	
Length (mm)	7.0
Curve	3/8
Diam. (mm)	0.33

AB-3382 **Nylon Suture, Lancet**
 Double-armed suture, measures 50cm in length. Lancet needle, measures 11.0mm in length, 3/8 curve, and 0.33mm in diameter.

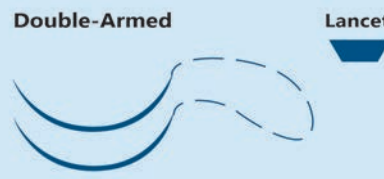

Suture	
Description	Nylon, Black Mono
Length (cm)	50
Size	6-0 (0.7 metric)

Needle	
Length (mm)	11.0
Curve	3/8
Diam. (mm)	0.33

AB-3382S **Nylon Suture, Lancet**
 Single-armed suture, measures 45cm in length. Lancet needle, measures 11.0mm in length, 3/8 curve, and 0.33mm in diameter.

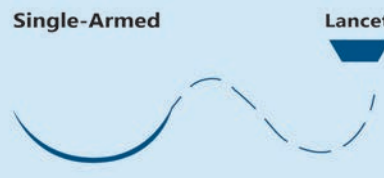

Suture	
Description	Nylon, Black Mono
Length (cm)	45
Size	6-0 (0.7 metric)

Needle	
Length (mm)	11.0
Curve	3/8
Diam. (mm)	0.33

NYLON



Item #	Description	Image																
AB-2859	<p>Nylon Suture, Trape Spatula</p> <p>Double-armed suture, measures 45cm in length. Trape spatula needle, measures 8.0mm in length, 7/16 curve, and 0.28mm in diameter.</p>	<table border="1"> <thead> <tr> <th colspan="2">Suture</th> </tr> </thead> <tbody> <tr> <td>Description</td> <td>Nylon, Black Mono</td> </tr> <tr> <td>Length (cm)</td> <td>45</td> </tr> <tr> <td>Size</td> <td>6-0 (0.7 metric)</td> </tr> </tbody> </table> <table border="1"> <thead> <tr> <th colspan="2">Needle</th> </tr> </thead> <tbody> <tr> <td>Length (mm)</td> <td>8.0</td> </tr> <tr> <td>Curve</td> <td>7/16</td> </tr> <tr> <td>Diam. (mm)</td> <td>0.28</td> </tr> </tbody> </table>	Suture		Description	Nylon, Black Mono	Length (cm)	45	Size	6-0 (0.7 metric)	Needle		Length (mm)	8.0	Curve	7/16	Diam. (mm)	0.28
Suture																		
Description	Nylon, Black Mono																	
Length (cm)	45																	
Size	6-0 (0.7 metric)																	
Needle																		
Length (mm)	8.0																	
Curve	7/16																	
Diam. (mm)	0.28																	
AB-3362S	<p>Nylon Suture, Lancet</p> <p>Single-armed suture, measures 50cm in length. Lancet needle, measures 8.0mm in length, 1/2 curve, and 0.33mm in diameter.</p>	<table border="1"> <thead> <tr> <th colspan="2">Suture</th> </tr> </thead> <tbody> <tr> <td>Description</td> <td>Nylon, Black Mono</td> </tr> <tr> <td>Length (cm)</td> <td>50</td> </tr> <tr> <td>Size</td> <td>6-0 (0.7 metric)</td> </tr> </tbody> </table> <table border="1"> <thead> <tr> <th colspan="2">Needle</th> </tr> </thead> <tbody> <tr> <td>Length (mm)</td> <td>8.0</td> </tr> <tr> <td>Curve</td> <td>1/2</td> </tr> <tr> <td>Diam. (mm)</td> <td>0.33</td> </tr> </tbody> </table>	Suture		Description	Nylon, Black Mono	Length (cm)	50	Size	6-0 (0.7 metric)	Needle		Length (mm)	8.0	Curve	1/2	Diam. (mm)	0.33
Suture																		
Description	Nylon, Black Mono																	
Length (cm)	50																	
Size	6-0 (0.7 metric)																	
Needle																		
Length (mm)	8.0																	
Curve	1/2																	
Diam. (mm)	0.33																	
AB-3381S	<p>Nylon Suture, Lancet</p> <p>Single-armed suture, measures 45cm in length. Lancet needle, measures 11.0mm in length, 1/2 curve, and 0.33mm in diameter.</p>	<table border="1"> <thead> <tr> <th colspan="2">Suture</th> </tr> </thead> <tbody> <tr> <td>Description</td> <td>Nylon, Black Mono</td> </tr> <tr> <td>Length (cm)</td> <td>45</td> </tr> <tr> <td>Size</td> <td>6-0 (0.7 metric)</td> </tr> </tbody> </table> <table border="1"> <thead> <tr> <th colspan="2">Needle</th> </tr> </thead> <tbody> <tr> <td>Length (mm)</td> <td>11.0</td> </tr> <tr> <td>Curve</td> <td>1/2</td> </tr> <tr> <td>Diam. (mm)</td> <td>0.33</td> </tr> </tbody> </table>	Suture		Description	Nylon, Black Mono	Length (cm)	45	Size	6-0 (0.7 metric)	Needle		Length (mm)	11.0	Curve	1/2	Diam. (mm)	0.33
Suture																		
Description	Nylon, Black Mono																	
Length (cm)	45																	
Size	6-0 (0.7 metric)																	
Needle																		
Length (mm)	11.0																	
Curve	1/2																	
Diam. (mm)	0.33																	
AB-3386	<p>Nylon Suture, Cut Taper</p> <p>Double-armed suture, measures 30cm in length. Cut taper needle, measures 15.0mm in length, 3/8 curve, and 0.33mm in diameter.</p>	<table border="1"> <thead> <tr> <th colspan="2">Suture</th> </tr> </thead> <tbody> <tr> <td>Description</td> <td>Nylon, Black Mono</td> </tr> <tr> <td>Length (cm)</td> <td>30</td> </tr> <tr> <td>Size</td> <td>6-0 (0.7 metric)</td> </tr> </tbody> </table> <table border="1"> <thead> <tr> <th colspan="2">Needle</th> </tr> </thead> <tbody> <tr> <td>Length (mm)</td> <td>15.0</td> </tr> <tr> <td>Curve</td> <td>3/8</td> </tr> <tr> <td>Diam. (mm)</td> <td>0.33</td> </tr> </tbody> </table>	Suture		Description	Nylon, Black Mono	Length (cm)	30	Size	6-0 (0.7 metric)	Needle		Length (mm)	15.0	Curve	3/8	Diam. (mm)	0.33
Suture																		
Description	Nylon, Black Mono																	
Length (cm)	30																	
Size	6-0 (0.7 metric)																	
Needle																		
Length (mm)	15.0																	
Curve	3/8																	
Diam. (mm)	0.33																	
AB-3853S	<p>Nylon Suture, Lancet</p> <p>Single-armed suture, measures 45cm in length. Lancet needle, measures 11.0mm in length, 3/8 curve, and 0.38mm in diameter.</p>	<table border="1"> <thead> <tr> <th colspan="2">Suture</th> </tr> </thead> <tbody> <tr> <td>Description</td> <td>Nylon, Black Mono</td> </tr> <tr> <td>Length (cm)</td> <td>45</td> </tr> <tr> <td>Size</td> <td>6-0 (0.7 metric)</td> </tr> </tbody> </table> <table border="1"> <thead> <tr> <th colspan="2">Needle</th> </tr> </thead> <tbody> <tr> <td>Length (mm)</td> <td>11.0</td> </tr> <tr> <td>Curve</td> <td>3/8</td> </tr> <tr> <td>Diam. (mm)</td> <td>0.38</td> </tr> </tbody> </table>	Suture		Description	Nylon, Black Mono	Length (cm)	45	Size	6-0 (0.7 metric)	Needle		Length (mm)	11.0	Curve	3/8	Diam. (mm)	0.38
Suture																		
Description	Nylon, Black Mono																	
Length (cm)	45																	
Size	6-0 (0.7 metric)																	
Needle																		
Length (mm)	11.0																	
Curve	3/8																	
Diam. (mm)	0.38																	

Sutures 5-0 Nylon

Mani brand 5-0, black mono, nylon sutures with both single and double arms. Lancet, reverse cut, dia spatula, and trape spatula needles ranging in length, curve, and diameter. Mani sutures are ideal for micro-suturing on the cornea and sclera during eye surgery. Ultimate sharpness is obtained through the "cross-lapped edge" technique giving each suture a fine and sharp tip ensuring minimally invasive wound closure. Mani hard fiber stainless steel is used to make strong and break-resistant needles. Sold 12 per box.

AB-2806	<p>Nylon Suture, Trape Spatula</p> <p>Double-armed suture, measures 30cm in length. Trape spatula needle, measures 6.0mm in length, 1/4 curve, and 0.28mm in diameter.</p>	<table border="1"> <thead> <tr> <th colspan="2">Suture</th> </tr> </thead> <tbody> <tr> <td>Description</td> <td>Nylon, Black Mono</td> </tr> <tr> <td>Length (cm)</td> <td>30</td> </tr> <tr> <td>Size</td> <td>5-0 (1.0 metric)</td> </tr> </tbody> </table> <table border="1"> <thead> <tr> <th colspan="2">Needle</th> </tr> </thead> <tbody> <tr> <td>Length (mm)</td> <td>6.0</td> </tr> <tr> <td>Curve</td> <td>1/4</td> </tr> <tr> <td>Diam. (mm)</td> <td>0.28</td> </tr> </tbody> </table>	Suture		Description	Nylon, Black Mono	Length (cm)	30	Size	5-0 (1.0 metric)	Needle		Length (mm)	6.0	Curve	1/4	Diam. (mm)	0.28
Suture																		
Description	Nylon, Black Mono																	
Length (cm)	30																	
Size	5-0 (1.0 metric)																	
Needle																		
Length (mm)	6.0																	
Curve	1/4																	
Diam. (mm)	0.28																	
AB-2807	<p>Nylon Suture, Dia Spatula</p> <p>Double-armed suture, measures 45cm in length. Dia spatula needle, measures 6.0mm in length, 1/4 curve, and 0.28mm in diameter.</p>	<table border="1"> <thead> <tr> <th colspan="2">Suture</th> </tr> </thead> <tbody> <tr> <td>Description</td> <td>Nylon, Black Mono</td> </tr> <tr> <td>Length (cm)</td> <td>45</td> </tr> <tr> <td>Size</td> <td>5-0 (1.0 metric)</td> </tr> </tbody> </table> <table border="1"> <thead> <tr> <th colspan="2">Needle</th> </tr> </thead> <tbody> <tr> <td>Length (mm)</td> <td>6.0</td> </tr> <tr> <td>Curve</td> <td>1/4</td> </tr> <tr> <td>Diam. (mm)</td> <td>0.28</td> </tr> </tbody> </table>	Suture		Description	Nylon, Black Mono	Length (cm)	45	Size	5-0 (1.0 metric)	Needle		Length (mm)	6.0	Curve	1/4	Diam. (mm)	0.28
Suture																		
Description	Nylon, Black Mono																	
Length (cm)	45																	
Size	5-0 (1.0 metric)																	
Needle																		
Length (mm)	6.0																	
Curve	1/4																	
Diam. (mm)	0.28																	

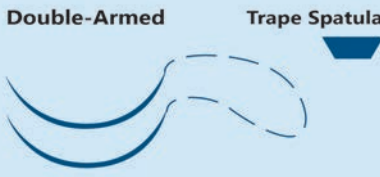
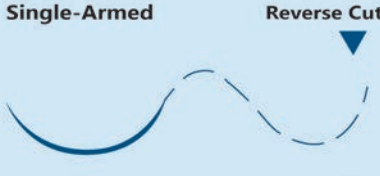
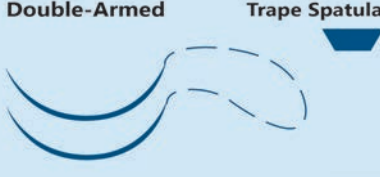
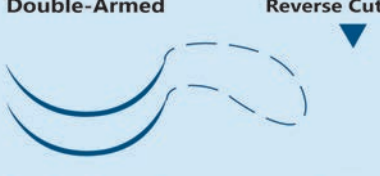
NYLON

Item #	Description	Image																
AB-2856	Nylon Suture, Trape Spatula Double-armed suture, measures 45cm in length. Trape spatula needle, measures 8.0mm in length, 3/8 curve, and 0.28mm in diameter.	 <table border="1"> <thead> <tr> <th colspan="2">Suture</th> </tr> </thead> <tbody> <tr> <td>Description</td> <td>Nylon, Black Mono</td> </tr> <tr> <td>Length (cm)</td> <td>45</td> </tr> <tr> <td>Size</td> <td>5-0 (1.0 metric)</td> </tr> </tbody> </table> <table border="1"> <thead> <tr> <th colspan="2">Needle</th> </tr> </thead> <tbody> <tr> <td>Length (mm)</td> <td>8.0</td> </tr> <tr> <td>Curve</td> <td>3/8</td> </tr> <tr> <td>Diam. (mm)</td> <td>0.28</td> </tr> </tbody> </table>	Suture		Description	Nylon, Black Mono	Length (cm)	45	Size	5-0 (1.0 metric)	Needle		Length (mm)	8.0	Curve	3/8	Diam. (mm)	0.28
Suture																		
Description	Nylon, Black Mono																	
Length (cm)	45																	
Size	5-0 (1.0 metric)																	
Needle																		
Length (mm)	8.0																	
Curve	3/8																	
Diam. (mm)	0.28																	
AB-3854S	Nylon Suture, Reverse Cut Single-armed suture, measures 45cm in length. Reverse cut needle, measures 11.0mm in length, 3/8 curve, and 0.38mm in diameter.	 <table border="1"> <thead> <tr> <th colspan="2">Suture</th> </tr> </thead> <tbody> <tr> <td>Description</td> <td>Nylon, Black Mono</td> </tr> <tr> <td>Length (cm)</td> <td>45</td> </tr> <tr> <td>Size</td> <td>5-0 (1.0 metric)</td> </tr> </tbody> </table> <table border="1"> <thead> <tr> <th colspan="2">Needle</th> </tr> </thead> <tbody> <tr> <td>Length (mm)</td> <td>11.0</td> </tr> <tr> <td>Curve</td> <td>3/8</td> </tr> <tr> <td>Diam. (mm)</td> <td>0.38</td> </tr> </tbody> </table>	Suture		Description	Nylon, Black Mono	Length (cm)	45	Size	5-0 (1.0 metric)	Needle		Length (mm)	11.0	Curve	3/8	Diam. (mm)	0.38
Suture																		
Description	Nylon, Black Mono																	
Length (cm)	45																	
Size	5-0 (1.0 metric)																	
Needle																		
Length (mm)	11.0																	
Curve	3/8																	
Diam. (mm)	0.38																	
AB-2865	Nylon Suture, Trape Spatula Double-armed suture, measures 45cm in length. Trape spatula needle, measures 7.0mm in length, 3/8 curve, and 0.28mm in diameter.	 <table border="1"> <thead> <tr> <th colspan="2">Suture</th> </tr> </thead> <tbody> <tr> <td>Description</td> <td>Nylon, Black Mono</td> </tr> <tr> <td>Length (cm)</td> <td>45</td> </tr> <tr> <td>Size</td> <td>5-0 (1.0 metric)</td> </tr> </tbody> </table> <table border="1"> <thead> <tr> <th colspan="2">Needle</th> </tr> </thead> <tbody> <tr> <td>Length (mm)</td> <td>7.0</td> </tr> <tr> <td>Curve</td> <td>3/8</td> </tr> <tr> <td>Diam. (mm)</td> <td>0.28</td> </tr> </tbody> </table>	Suture		Description	Nylon, Black Mono	Length (cm)	45	Size	5-0 (1.0 metric)	Needle		Length (mm)	7.0	Curve	3/8	Diam. (mm)	0.28
Suture																		
Description	Nylon, Black Mono																	
Length (cm)	45																	
Size	5-0 (1.0 metric)																	
Needle																		
Length (mm)	7.0																	
Curve	3/8																	
Diam. (mm)	0.28																	
AB-3854	Nylon Suture, Reverse Cut Double-armed suture, measures 50cm in length. Reverse cut needle, measures 11.0mm in length, 3/8 curve, and 0.38mm in diameter.	 <table border="1"> <thead> <tr> <th colspan="2">Suture</th> </tr> </thead> <tbody> <tr> <td>Description</td> <td>Nylon, Black Mono</td> </tr> <tr> <td>Length (cm)</td> <td>50</td> </tr> <tr> <td>Size</td> <td>5-0 (1.0 metric)</td> </tr> </tbody> </table> <table border="1"> <thead> <tr> <th colspan="2">Needle</th> </tr> </thead> <tbody> <tr> <td>Length (mm)</td> <td>11.0</td> </tr> <tr> <td>Curve</td> <td>3/8</td> </tr> <tr> <td>Diam. (mm)</td> <td>0.38</td> </tr> </tbody> </table>	Suture		Description	Nylon, Black Mono	Length (cm)	50	Size	5-0 (1.0 metric)	Needle		Length (mm)	11.0	Curve	3/8	Diam. (mm)	0.38
Suture																		
Description	Nylon, Black Mono																	
Length (cm)	50																	
Size	5-0 (1.0 metric)																	
Needle																		
Length (mm)	11.0																	
Curve	3/8																	
Diam. (mm)	0.38																	
AB-3383S	Nylon Suture, Lancet Single-armed suture, measures 45cm in length. Lancet needle, measures 11.0mm in length, 1/2 curve, and 0.33mm in diameter.	 <table border="1"> <thead> <tr> <th colspan="2">Suture</th> </tr> </thead> <tbody> <tr> <td>Description</td> <td>Nylon, Black Mono</td> </tr> <tr> <td>Length (cm)</td> <td>45</td> </tr> <tr> <td>Size</td> <td>5-0 (1.0 metric)</td> </tr> </tbody> </table> <table border="1"> <thead> <tr> <th colspan="2">Needle</th> </tr> </thead> <tbody> <tr> <td>Length (mm)</td> <td>11.0</td> </tr> <tr> <td>Curve</td> <td>1/2</td> </tr> <tr> <td>Diam. (mm)</td> <td>0.33</td> </tr> </tbody> </table>	Suture		Description	Nylon, Black Mono	Length (cm)	45	Size	5-0 (1.0 metric)	Needle		Length (mm)	11.0	Curve	1/2	Diam. (mm)	0.33
Suture																		
Description	Nylon, Black Mono																	
Length (cm)	45																	
Size	5-0 (1.0 metric)																	
Needle																		
Length (mm)	11.0																	
Curve	1/2																	
Diam. (mm)	0.33																	

POLYESTER

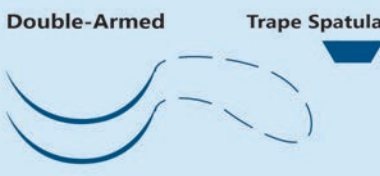
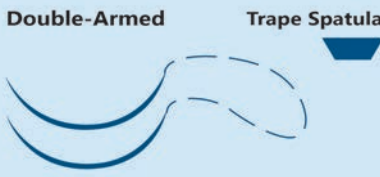
Item #	Description	Image																
Sutures 10-0 Polyester																		
Mani brand 10-0, green mono, polyester sutures with double arms. Trape spatula needles ranging in length, curve, and diameter. Mani sutures are ideal for micro-suturing on the cornea and sclera during eye surgery. Ultimate sharpness is obtained through the "cross-lapped edge" technique giving each suture a fine and sharp tip ensuring minimally invasive wound closure. Mani hard fiber stainless steel is used to make strong and break-resistant needles. Sold 12 per box.																		
AB-1411	Polyester Suture, Trape Spatula Double-armed suture, measures 30cm in length. Trape spatula needle, measures 5.5mm in length, 7/16 curve, and 0.14mm in diameter.	 <table border="1"> <thead> <tr> <th colspan="2">Suture</th> </tr> </thead> <tbody> <tr> <td>Description</td> <td>Polyester, Green Mono</td> </tr> <tr> <td>Length (cm)</td> <td>30</td> </tr> <tr> <td>Size</td> <td>10-0 (0.2 metric)</td> </tr> </tbody> </table> <table border="1"> <thead> <tr> <th colspan="2">Needle</th> </tr> </thead> <tbody> <tr> <td>Length (mm)</td> <td>5.5</td> </tr> <tr> <td>Curve</td> <td>7/16</td> </tr> <tr> <td>Diam. (mm)</td> <td>0.14</td> </tr> </tbody> </table>	Suture		Description	Polyester, Green Mono	Length (cm)	30	Size	10-0 (0.2 metric)	Needle		Length (mm)	5.5	Curve	7/16	Diam. (mm)	0.14
Suture																		
Description	Polyester, Green Mono																	
Length (cm)	30																	
Size	10-0 (0.2 metric)																	
Needle																		
Length (mm)	5.5																	
Curve	7/16																	
Diam. (mm)	0.14																	
AB-2017	Polyester Suture, Trape Spatula Double-armed suture, measures 30cm in length. Trape spatula needle, measures 6.5mm in length, 3/8 curve, and 0.20mm in diameter.	 <table border="1"> <thead> <tr> <th colspan="2">Suture</th> </tr> </thead> <tbody> <tr> <td>Description</td> <td>Polyester, Green Mono</td> </tr> <tr> <td>Length (cm)</td> <td>30</td> </tr> <tr> <td>Size</td> <td>10-0 (0.2 metric)</td> </tr> </tbody> </table> <table border="1"> <thead> <tr> <th colspan="2">Needle</th> </tr> </thead> <tbody> <tr> <td>Length (mm)</td> <td>6.5</td> </tr> <tr> <td>Curve</td> <td>3/8</td> </tr> <tr> <td>Diam. (mm)</td> <td>0.20</td> </tr> </tbody> </table>	Suture		Description	Polyester, Green Mono	Length (cm)	30	Size	10-0 (0.2 metric)	Needle		Length (mm)	6.5	Curve	3/8	Diam. (mm)	0.20
Suture																		
Description	Polyester, Green Mono																	
Length (cm)	30																	
Size	10-0 (0.2 metric)																	
Needle																		
Length (mm)	6.5																	
Curve	3/8																	
Diam. (mm)	0.20																	

POLYESTER

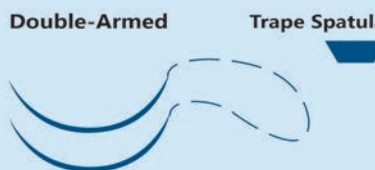
Item #	Description	Image	Suture	Needle												
AB-1412	Polyester Suture, Trape Spatula Double-armed suture, measures 30cm in length. Trape spatula needle, measures 6.0mm in length, 3/8 curve, and 0.14mm in diameter.		<table border="1"> <tr><td>Description</td><td>Polyester, Green Mono</td></tr> <tr><td>Length (cm)</td><td>30</td></tr> <tr><td>Size</td><td>10-0 (0.2 metric)</td></tr> </table>	Description	Polyester, Green Mono	Length (cm)	30	Size	10-0 (0.2 metric)	<table border="1"> <tr><td>Length (mm)</td><td>6.0</td></tr> <tr><td>Curve</td><td>3/8</td></tr> <tr><td>Diam. (mm)</td><td>0.14</td></tr> </table>	Length (mm)	6.0	Curve	3/8	Diam. (mm)	0.14
Description	Polyester, Green Mono															
Length (cm)	30															
Size	10-0 (0.2 metric)															
Length (mm)	6.0															
Curve	3/8															
Diam. (mm)	0.14															

Sutures 5-0 Polyester

Mani brand 5-0, green or white braided, polyester sutures with double arms. Trape spatula, dia spatula, and taper point needles ranging in length, curve, and diameter. Mani sutures are ideal for micro-suturing on the cornea and sclera during eye surgery. Ultimate sharpness is obtained through the "cross-lapped edge" technique giving each suture a fine and sharp tip ensuring minimally invasive wound closure. Mani hard fiber stainless steel is used to make strong and break-resistant needles. Sold 12 per box.

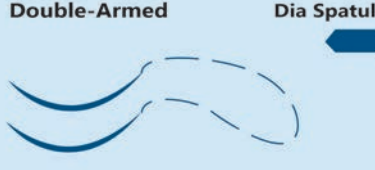
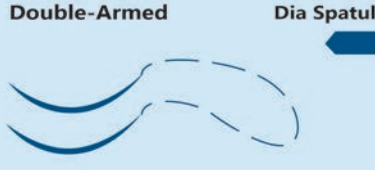
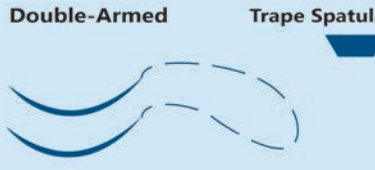
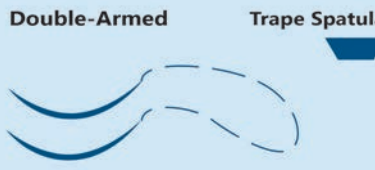
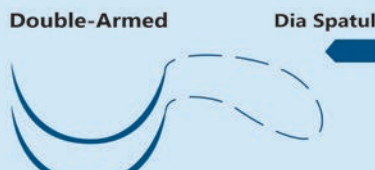
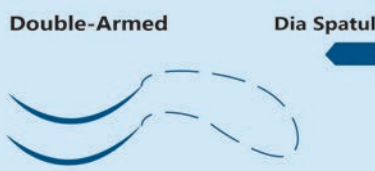
AB-2863	Polyester Suture, Dia Spatula White braided, double-armed suture, measures 45cm in length. Dia spatula needle, measures 6.0mm in length, 1/4 curve, and 0.28mm in diameter.		<table border="1"> <tr><td>Description</td><td>Polyester, White Braided</td></tr> <tr><td>Length (cm)</td><td>45</td></tr> <tr><td>Size</td><td>5-0 (1.0 metric)</td></tr> </table>	Description	Polyester, White Braided	Length (cm)	45	Size	5-0 (1.0 metric)	<table border="1"> <tr><td>Length (mm)</td><td>6.0</td></tr> <tr><td>Curve</td><td>1/4</td></tr> <tr><td>Diam. (mm)</td><td>0.28</td></tr> </table>	Length (mm)	6.0	Curve	1/4	Diam. (mm)	0.28
Description	Polyester, White Braided															
Length (cm)	45															
Size	5-0 (1.0 metric)															
Length (mm)	6.0															
Curve	1/4															
Diam. (mm)	0.28															
AB-3370	Polyester Suture, Dia Spatula White braided, double-armed suture, measures 45cm in length. Dia spatula needle, measures 8.0mm in length, 1/4 curve, and 0.33mm in diameter.		<table border="1"> <tr><td>Description</td><td>Polyester, White Braided</td></tr> <tr><td>Length (cm)</td><td>45</td></tr> <tr><td>Size</td><td>5-0 (1.0 metric)</td></tr> </table>	Description	Polyester, White Braided	Length (cm)	45	Size	5-0 (1.0 metric)	<table border="1"> <tr><td>Length (mm)</td><td>8.0</td></tr> <tr><td>Curve</td><td>1/4</td></tr> <tr><td>Diam. (mm)</td><td>0.33</td></tr> </table>	Length (mm)	8.0	Curve	1/4	Diam. (mm)	0.33
Description	Polyester, White Braided															
Length (cm)	45															
Size	5-0 (1.0 metric)															
Length (mm)	8.0															
Curve	1/4															
Diam. (mm)	0.33															
AB-3376	Polyester Suture, Trape Spatula Green braided, double-armed suture, measures 45cm in length. Trape spatula needle, measures 8.0mm in length, 1/4 curve, and 0.33mm in diameter.		<table border="1"> <tr><td>Description</td><td>Polyester, Green Braided</td></tr> <tr><td>Length (cm)</td><td>45</td></tr> <tr><td>Size</td><td>5-0 (1.0 metric)</td></tr> </table>	Description	Polyester, Green Braided	Length (cm)	45	Size	5-0 (1.0 metric)	<table border="1"> <tr><td>Length (mm)</td><td>8.0</td></tr> <tr><td>Curve</td><td>1/4</td></tr> <tr><td>Diam. (mm)</td><td>0.33</td></tr> </table>	Length (mm)	8.0	Curve	1/4	Diam. (mm)	0.33
Description	Polyester, Green Braided															
Length (cm)	45															
Size	5-0 (1.0 metric)															
Length (mm)	8.0															
Curve	1/4															
Diam. (mm)	0.33															
AB-3377	Polyester Suture, Trape Spatula White braided, double-armed suture, measures 45cm in length. Trape spatula needle, measures 8.0mm in length, 1/4 curve, and 0.33mm in diameter.		<table border="1"> <tr><td>Description</td><td>Polyester, White Braided</td></tr> <tr><td>Length (cm)</td><td>45</td></tr> <tr><td>Size</td><td>5-0 (1.0 metric)</td></tr> </table>	Description	Polyester, White Braided	Length (cm)	45	Size	5-0 (1.0 metric)	<table border="1"> <tr><td>Length (mm)</td><td>8.0</td></tr> <tr><td>Curve</td><td>1/4</td></tr> <tr><td>Diam. (mm)</td><td>0.33</td></tr> </table>	Length (mm)	8.0	Curve	1/4	Diam. (mm)	0.33
Description	Polyester, White Braided															
Length (cm)	45															
Size	5-0 (1.0 metric)															
Length (mm)	8.0															
Curve	1/4															
Diam. (mm)	0.33															
AB-3371	Polyester Suture, Dia Spatula White braided, double-armed suture, measures 45cm in length. Dia spatula needle, measures 8.0mm in length, 1/2 curve, and 0.33mm in diameter.		<table border="1"> <tr><td>Description</td><td>Polyester, White Braided</td></tr> <tr><td>Length (cm)</td><td>45</td></tr> <tr><td>Size</td><td>5-0 (1.0 metric)</td></tr> </table>	Description	Polyester, White Braided	Length (cm)	45	Size	5-0 (1.0 metric)	<table border="1"> <tr><td>Length (mm)</td><td>8.0</td></tr> <tr><td>Curve</td><td>1/2</td></tr> <tr><td>Diam. (mm)</td><td>0.33</td></tr> </table>	Length (mm)	8.0	Curve	1/2	Diam. (mm)	0.33
Description	Polyester, White Braided															
Length (cm)	45															
Size	5-0 (1.0 metric)															
Length (mm)	8.0															
Curve	1/2															
Diam. (mm)	0.33															
AB-3372	Polyester Suture, Dia Spatula White braided, double-armed suture, measures 45cm in length. Dia spatula needle, measures 6.0mm in length, 1/4 curve, and 0.33mm in diameter.		<table border="1"> <tr><td>Description</td><td>Polyester, White Braided</td></tr> <tr><td>Length (cm)</td><td>45</td></tr> <tr><td>Size</td><td>5-0 (1.0 metric)</td></tr> </table>	Description	Polyester, White Braided	Length (cm)	45	Size	5-0 (1.0 metric)	<table border="1"> <tr><td>Length (mm)</td><td>6.0</td></tr> <tr><td>Curve</td><td>1/4</td></tr> <tr><td>Diam. (mm)</td><td>0.33</td></tr> </table>	Length (mm)	6.0	Curve	1/4	Diam. (mm)	0.33
Description	Polyester, White Braided															
Length (cm)	45															
Size	5-0 (1.0 metric)															
Length (mm)	6.0															
Curve	1/4															
Diam. (mm)	0.33															

POLYESTER



Item #	Description	Image																
AB-3373	<p>Polyester Suture, Dia Spatula</p> <p>Green braided, double-armed suture, measures 45cm in length. Dia spatula needle, measures 8.0mm in length, 1/4 curve, and 0.33mm in diameter.</p>	<table border="1"> <thead> <tr> <th colspan="2">Suture</th> </tr> </thead> <tbody> <tr> <td>Description</td> <td>Polyester, Green Braided</td> </tr> <tr> <td>Length (cm)</td> <td>45</td> </tr> <tr> <td>Size</td> <td>5-0 (1.0 metric)</td> </tr> </tbody> </table> <table border="1"> <thead> <tr> <th colspan="2">Needle</th> </tr> </thead> <tbody> <tr> <td>Length (mm)</td> <td>8.0</td> </tr> <tr> <td>Curve</td> <td>1/4</td> </tr> <tr> <td>Diam. (mm)</td> <td>0.33</td> </tr> </tbody> </table>	Suture		Description	Polyester, Green Braided	Length (cm)	45	Size	5-0 (1.0 metric)	Needle		Length (mm)	8.0	Curve	1/4	Diam. (mm)	0.33
Suture																		
Description	Polyester, Green Braided																	
Length (cm)	45																	
Size	5-0 (1.0 metric)																	
Needle																		
Length (mm)	8.0																	
Curve	1/4																	
Diam. (mm)	0.33																	
AB-3380	<p>Polyester Suture, Taper Point</p> <p>White braided, double-armed suture, measures 75cm in length. Taper point needle, measures 10.0mm in length, 3/8 curve, and 0.33mm in diameter.</p>	<table border="1"> <thead> <tr> <th colspan="2">Suture</th> </tr> </thead> <tbody> <tr> <td>Description</td> <td>Polyester, White Braided</td> </tr> <tr> <td>Length (cm)</td> <td>75</td> </tr> <tr> <td>Size</td> <td>5-0 (1.0 metric)</td> </tr> </tbody> </table> <table border="1"> <thead> <tr> <th colspan="2">Needle</th> </tr> </thead> <tbody> <tr> <td>Length (mm)</td> <td>10.0</td> </tr> <tr> <td>Curve</td> <td>3/8</td> </tr> <tr> <td>Diam. (mm)</td> <td>0.33</td> </tr> </tbody> </table>	Suture		Description	Polyester, White Braided	Length (cm)	75	Size	5-0 (1.0 metric)	Needle		Length (mm)	10.0	Curve	3/8	Diam. (mm)	0.33
Suture																		
Description	Polyester, White Braided																	
Length (cm)	75																	
Size	5-0 (1.0 metric)																	
Needle																		
Length (mm)	10.0																	
Curve	3/8																	
Diam. (mm)	0.33																	
AB-3374	<p>Polyester Suture, Dia Spatula</p> <p>Green braided, double-armed suture, measures 45cm in length. Dia spatula needle, measures 8.0mm in length, 1/4 curve, and 0.33mm in diameter.</p>	<table border="1"> <thead> <tr> <th colspan="2">Suture</th> </tr> </thead> <tbody> <tr> <td>Description</td> <td>Polyester, Green Braided</td> </tr> <tr> <td>Length (cm)</td> <td>45</td> </tr> <tr> <td>Size</td> <td>5-0 (1.0 metric)</td> </tr> </tbody> </table> <table border="1"> <thead> <tr> <th colspan="2">Needle</th> </tr> </thead> <tbody> <tr> <td>Length (mm)</td> <td>8.0</td> </tr> <tr> <td>Curve</td> <td>1/4</td> </tr> <tr> <td>Diam. (mm)</td> <td>0.33</td> </tr> </tbody> </table>	Suture		Description	Polyester, Green Braided	Length (cm)	45	Size	5-0 (1.0 metric)	Needle		Length (mm)	8.0	Curve	1/4	Diam. (mm)	0.33
Suture																		
Description	Polyester, Green Braided																	
Length (cm)	45																	
Size	5-0 (1.0 metric)																	
Needle																		
Length (mm)	8.0																	
Curve	1/4																	
Diam. (mm)	0.33																	
AB-3375	<p>Polyester Suture, Dia Spatula</p> <p>Green braided, double-armed suture, measures 45cm in length. Dia spatula needle, measures 6.0mm in length, 1/4 curve, and 0.33mm in diameter.</p>	<table border="1"> <thead> <tr> <th colspan="2">Suture</th> </tr> </thead> <tbody> <tr> <td>Description</td> <td>Polyester, Green Braided</td> </tr> <tr> <td>Length (cm)</td> <td>45</td> </tr> <tr> <td>Size</td> <td>5-0 (1.0 metric)</td> </tr> </tbody> </table> <table border="1"> <thead> <tr> <th colspan="2">Needle</th> </tr> </thead> <tbody> <tr> <td>Length (mm)</td> <td>6.0</td> </tr> <tr> <td>Curve</td> <td>1/4</td> </tr> <tr> <td>Diam. (mm)</td> <td>0.33</td> </tr> </tbody> </table>	Suture		Description	Polyester, Green Braided	Length (cm)	45	Size	5-0 (1.0 metric)	Needle		Length (mm)	6.0	Curve	1/4	Diam. (mm)	0.33
Suture																		
Description	Polyester, Green Braided																	
Length (cm)	45																	
Size	5-0 (1.0 metric)																	
Needle																		
Length (mm)	6.0																	
Curve	1/4																	
Diam. (mm)	0.33																	
AB-3378	<p>Polyester Suture, Taper Point</p> <p>Green braided, double-armed suture, measures 75cm in length. Taper point needle, measures 10.0mm in length, 3/8 curve, and 0.33mm in diameter.</p>	<table border="1"> <thead> <tr> <th colspan="2">Suture</th> </tr> </thead> <tbody> <tr> <td>Description</td> <td>Polyester, Green Braided</td> </tr> <tr> <td>Length (cm)</td> <td>75</td> </tr> <tr> <td>Size</td> <td>5-0 (1.0 metric)</td> </tr> </tbody> </table> <table border="1"> <thead> <tr> <th colspan="2">Needle</th> </tr> </thead> <tbody> <tr> <td>Length (mm)</td> <td>10.0</td> </tr> <tr> <td>Curve</td> <td>3/8</td> </tr> <tr> <td>Diam. (mm)</td> <td>0.33</td> </tr> </tbody> </table>	Suture		Description	Polyester, Green Braided	Length (cm)	75	Size	5-0 (1.0 metric)	Needle		Length (mm)	10.0	Curve	3/8	Diam. (mm)	0.33
Suture																		
Description	Polyester, Green Braided																	
Length (cm)	75																	
Size	5-0 (1.0 metric)																	
Needle																		
Length (mm)	10.0																	
Curve	3/8																	
Diam. (mm)	0.33																	

Sutures 4-0 Polyester

Mani brand 4-0, green or white braided, polyester sutures with double arms. Trape spatula and dia spatula needles ranging in length, curve, and diameter. Mani sutures are ideal for micro-suturing on the cornea and sclera during eye surgery. Ultimate sharpness is obtained through the "cross-lapped edge" technique giving each suture a fine and sharp tip ensuring minimally invasive wound closure. Mani hard fiber stainless steel is used to make strong and break-resistant needles. Sold 12 per box.

AB-4355	<p>Polyester Suture, Trape Spatula</p> <p>Green braided, double-armed suture, measures 45cm in length. Trape spatula needle, measures 8.0mm in length, 1/4 curve, and 0.43mm in diameter.</p>	<table border="1"> <thead> <tr> <th colspan="2">Suture</th> </tr> </thead> <tbody> <tr> <td>Description</td> <td>Polyester, Green Braided</td> </tr> <tr> <td>Length (cm)</td> <td>45</td> </tr> <tr> <td>Size</td> <td>4-0 (1.5 metric)</td> </tr> </tbody> </table> <table border="1"> <thead> <tr> <th colspan="2">Needle</th> </tr> </thead> <tbody> <tr> <td>Length (mm)</td> <td>8.0</td> </tr> <tr> <td>Curve</td> <td>1/4</td> </tr> <tr> <td>Diam. (mm)</td> <td>0.43</td> </tr> </tbody> </table>	Suture		Description	Polyester, Green Braided	Length (cm)	45	Size	4-0 (1.5 metric)	Needle		Length (mm)	8.0	Curve	1/4	Diam. (mm)	0.43
Suture																		
Description	Polyester, Green Braided																	
Length (cm)	45																	
Size	4-0 (1.5 metric)																	
Needle																		
Length (mm)	8.0																	
Curve	1/4																	
Diam. (mm)	0.43																	
AB-4353	<p>Polyester Suture, Dia Spatula</p> <p>Green braided, double-armed suture, measures 45cm in length. Dia spatula needle, measures 8.0mm in length, 1/4 curve, and 0.43mm in diameter.</p>	<table border="1"> <thead> <tr> <th colspan="2">Suture</th> </tr> </thead> <tbody> <tr> <td>Description</td> <td>Polyester, Green Braided</td> </tr> <tr> <td>Length (cm)</td> <td>45</td> </tr> <tr> <td>Size</td> <td>4-0 (1.5 metric)</td> </tr> </tbody> </table> <table border="1"> <thead> <tr> <th colspan="2">Needle</th> </tr> </thead> <tbody> <tr> <td>Length (mm)</td> <td>8.0</td> </tr> <tr> <td>Curve</td> <td>1/4</td> </tr> <tr> <td>Diam. (mm)</td> <td>0.43</td> </tr> </tbody> </table>	Suture		Description	Polyester, Green Braided	Length (cm)	45	Size	4-0 (1.5 metric)	Needle		Length (mm)	8.0	Curve	1/4	Diam. (mm)	0.43
Suture																		
Description	Polyester, Green Braided																	
Length (cm)	45																	
Size	4-0 (1.5 metric)																	
Needle																		
Length (mm)	8.0																	
Curve	1/4																	
Diam. (mm)	0.43																	

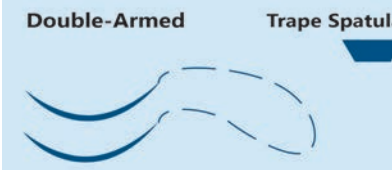
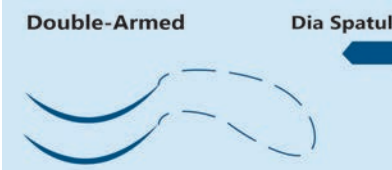
POLYESTER

Item #	Description	Image																
AB-4356	<p>Polyester Suture, Trape Spatula</p> <p>White braided, double-armed suture, measures 45cm in length. Trape spatula needle, measures 8.0mm in length, 1/4 curve, and 0.43mm in diameter.</p>	 <table border="1"> <thead> <tr> <th colspan="2">Suture</th> </tr> </thead> <tbody> <tr> <td>Description</td> <td>Polyester, White Braided</td> </tr> <tr> <td>Length (cm)</td> <td>45</td> </tr> <tr> <td>Size</td> <td>4-0 (1.5 metric)</td> </tr> </tbody> </table> <table border="1"> <thead> <tr> <th colspan="2">Needle</th> </tr> </thead> <tbody> <tr> <td>Length (mm)</td> <td>8.0</td> </tr> <tr> <td>Curve</td> <td>1/4</td> </tr> <tr> <td>Diam. (mm)</td> <td>0.43</td> </tr> </tbody> </table>	Suture		Description	Polyester, White Braided	Length (cm)	45	Size	4-0 (1.5 metric)	Needle		Length (mm)	8.0	Curve	1/4	Diam. (mm)	0.43
Suture																		
Description	Polyester, White Braided																	
Length (cm)	45																	
Size	4-0 (1.5 metric)																	
Needle																		
Length (mm)	8.0																	
Curve	1/4																	
Diam. (mm)	0.43																	
AB-4357	<p>Polyester Suture, Dia Spatula</p> <p>White braided, double-armed suture, measures 45cm in length. Dia spatula needle, measures 6.5mm in length, 1/4 curve, and 0.43mm in diameter.</p>	 <table border="1"> <thead> <tr> <th colspan="2">Suture</th> </tr> </thead> <tbody> <tr> <td>Description</td> <td>Polyester, White Braided</td> </tr> <tr> <td>Length (cm)</td> <td>45</td> </tr> <tr> <td>Size</td> <td>4-0 (1.5 metric)</td> </tr> </tbody> </table> <table border="1"> <thead> <tr> <th colspan="2">Needle</th> </tr> </thead> <tbody> <tr> <td>Length (mm)</td> <td>6.5</td> </tr> <tr> <td>Curve</td> <td>1/4</td> </tr> <tr> <td>Diam. (mm)</td> <td>0.43</td> </tr> </tbody> </table>	Suture		Description	Polyester, White Braided	Length (cm)	45	Size	4-0 (1.5 metric)	Needle		Length (mm)	6.5	Curve	1/4	Diam. (mm)	0.43
Suture																		
Description	Polyester, White Braided																	
Length (cm)	45																	
Size	4-0 (1.5 metric)																	
Needle																		
Length (mm)	6.5																	
Curve	1/4																	
Diam. (mm)	0.43																	
AB-4352	<p>Polyester Suture, Dia Spatula</p> <p>White braided, double-armed suture, measures 45cm in length. Dia spatula needle, measures 8.0mm in length, 1/4 curve, and 0.43mm in diameter.</p>	 <table border="1"> <thead> <tr> <th colspan="2">Suture</th> </tr> </thead> <tbody> <tr> <td>Description</td> <td>Polyester, White Braided</td> </tr> <tr> <td>Length (cm)</td> <td>45</td> </tr> <tr> <td>Size</td> <td>4-0 (1.5 metric)</td> </tr> </tbody> </table> <table border="1"> <thead> <tr> <th colspan="2">Needle</th> </tr> </thead> <tbody> <tr> <td>Length (mm)</td> <td>8.0</td> </tr> <tr> <td>Curve</td> <td>1/4</td> </tr> <tr> <td>Diam. (mm)</td> <td>0.43</td> </tr> </tbody> </table>	Suture		Description	Polyester, White Braided	Length (cm)	45	Size	4-0 (1.5 metric)	Needle		Length (mm)	8.0	Curve	1/4	Diam. (mm)	0.43
Suture																		
Description	Polyester, White Braided																	
Length (cm)	45																	
Size	4-0 (1.5 metric)																	
Needle																		
Length (mm)	8.0																	
Curve	1/4																	
Diam. (mm)	0.43																	

POLYGLYCOLIC ACID

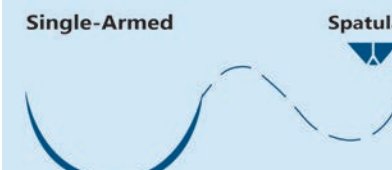
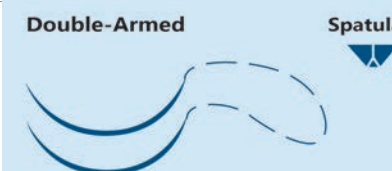
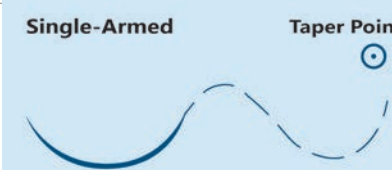
Item #	Description	Image																
Sutures 10-0 Polyglycolic Acid																		
<p>Peters brand 10-0, violet braided, polyglycolic acid sutures with single and double arms. Spatula and taper point needles ranging in length, curve, and diameter. Sinus Point is the brand of sutures manufactured by Peters Surgical, with years of experience, exceptional know-how, and a 100% quality control guaranteeing an excellent product recognized by the best surgeons around the world. Sinus Point micro-needles are manufactured with the highest medical stainless steel AISI 304V. This material makes Peters sutures unbreakable. Sold 12 per box.</p>																		
AXI4039	<p>PGA Suture, Spatula</p> <p>Single-armed suture, measures 30cm in length. Spatula needle, measures 6.0mm in length, 1/2 curve, and 0.15mm in diameter.</p>	 <table border="1"> <thead> <tr> <th colspan="2">Suture</th> </tr> </thead> <tbody> <tr> <td>Description</td> <td>Polyglycolic Acid, Violet Braid</td> </tr> <tr> <td>Length (cm)</td> <td>30</td> </tr> <tr> <td>Size</td> <td>10-0 (0.2 metric)</td> </tr> </tbody> </table> <table border="1"> <thead> <tr> <th colspan="2">Needle</th> </tr> </thead> <tbody> <tr> <td>Length (mm)</td> <td>6.0</td> </tr> <tr> <td>Curve</td> <td>1/2</td> </tr> <tr> <td>Diam. (mm)</td> <td>0.15</td> </tr> </tbody> </table>	Suture		Description	Polyglycolic Acid, Violet Braid	Length (cm)	30	Size	10-0 (0.2 metric)	Needle		Length (mm)	6.0	Curve	1/2	Diam. (mm)	0.15
Suture																		
Description	Polyglycolic Acid, Violet Braid																	
Length (cm)	30																	
Size	10-0 (0.2 metric)																	
Needle																		
Length (mm)	6.0																	
Curve	1/2																	
Diam. (mm)	0.15																	
AXI4040	<p>PGA Suture, Spatula</p> <p>Double-armed suture, measures 30cm in length. Spatula needle, measures 6.4mm in length, 3/8 curve, and 0.20mm in diameter.</p>	 <table border="1"> <thead> <tr> <th colspan="2">Suture</th> </tr> </thead> <tbody> <tr> <td>Description</td> <td>Polyglycolic Acid, Violet Braid</td> </tr> <tr> <td>Length (cm)</td> <td>30</td> </tr> <tr> <td>Size</td> <td>10-0 (0.2 metric)</td> </tr> </tbody> </table> <table border="1"> <thead> <tr> <th colspan="2">Needle</th> </tr> </thead> <tbody> <tr> <td>Length (mm)</td> <td>6.4</td> </tr> <tr> <td>Curve</td> <td>3/8</td> </tr> <tr> <td>Diam. (mm)</td> <td>0.20</td> </tr> </tbody> </table>	Suture		Description	Polyglycolic Acid, Violet Braid	Length (cm)	30	Size	10-0 (0.2 metric)	Needle		Length (mm)	6.4	Curve	3/8	Diam. (mm)	0.20
Suture																		
Description	Polyglycolic Acid, Violet Braid																	
Length (cm)	30																	
Size	10-0 (0.2 metric)																	
Needle																		
Length (mm)	6.4																	
Curve	3/8																	
Diam. (mm)	0.20																	
AB-8137	<p>PGA Suture, Taper Point</p> <p>Single-armed suture, measures 15cm in length. Taper point needle, measures 5.0mm in length, 3/8 curve, and 0.20mm in diameter.</p>	 <table border="1"> <thead> <tr> <th colspan="2">Suture</th> </tr> </thead> <tbody> <tr> <td>Description</td> <td>Polyglycolic Acid, Violet Braid</td> </tr> <tr> <td>Length (cm)</td> <td>15</td> </tr> <tr> <td>Size</td> <td>10-0 (0.2 metric)</td> </tr> </tbody> </table> <table border="1"> <thead> <tr> <th colspan="2">Needle</th> </tr> </thead> <tbody> <tr> <td>Length (mm)</td> <td>5.0</td> </tr> <tr> <td>Curve</td> <td>3/8</td> </tr> <tr> <td>Diam. (mm)</td> <td>0.20</td> </tr> </tbody> </table>	Suture		Description	Polyglycolic Acid, Violet Braid	Length (cm)	15	Size	10-0 (0.2 metric)	Needle		Length (mm)	5.0	Curve	3/8	Diam. (mm)	0.20
Suture																		
Description	Polyglycolic Acid, Violet Braid																	
Length (cm)	15																	
Size	10-0 (0.2 metric)																	
Needle																		
Length (mm)	5.0																	
Curve	3/8																	
Diam. (mm)	0.20																	

POLYGLYCOLIC ACID

Item #	Description	Image	Suture																
AXI4510	PGA Suture, Taper Point Single-armed suture, measures 30cm in length. Taper point needle, measures 4.0mm in length, 3/8 curve, and 0.20mm in diameter.	<p>Single-Armed Taper Point</p>	<table border="1"> <tr><th colspan="2">Suture</th></tr> <tr><td>Description</td><td>Polyglycolic Acid, Violet Braid</td></tr> <tr><td>Length (cm)</td><td>30</td></tr> <tr><td>Size</td><td>10-0 (0.2 metric)</td></tr> </table> <table border="1"> <tr><th colspan="2">Needle</th></tr> <tr><td>Length (mm)</td><td>4.0</td></tr> <tr><td>Curve</td><td>3/8</td></tr> <tr><td>Diam. (mm)</td><td>0.20</td></tr> </table>	Suture		Description	Polyglycolic Acid, Violet Braid	Length (cm)	30	Size	10-0 (0.2 metric)	Needle		Length (mm)	4.0	Curve	3/8	Diam. (mm)	0.20
Suture																			
Description	Polyglycolic Acid, Violet Braid																		
Length (cm)	30																		
Size	10-0 (0.2 metric)																		
Needle																			
Length (mm)	4.0																		
Curve	3/8																		
Diam. (mm)	0.20																		

Sutures 9-0 Polyglycolic Acid

Peters brand 9-0, violet braided, polyglycolic acid sutures with single and double arms. Spatula needles ranging in length, curve, and diameter. Sinus Point is the brand of sutures manufactured by Peters Surgical, with years of experience, exceptional know-how, and a 100% quality control guaranteeing an excellent product recognized by the best surgeons around the world. Sinus Point micro-needles are manufactured with the highest medical stainless steel AISI 304V. This material makes Peters sutures unbreakable. Sold 12 per box.

AXI4041	PGA Suture, Spatula Single-armed suture, measures 30cm in length. Spatula needle, measures 6.4mm in length, 3/8 curve, and 0.20mm in diameter.	<p>Single-Armed Spatula</p>	<table border="1"> <tr><th colspan="2">Suture</th></tr> <tr><td>Description</td><td>Polyglycolic Acid, Violet Braid</td></tr> <tr><td>Length (cm)</td><td>30</td></tr> <tr><td>Size</td><td>9-0 (0.3 metric)</td></tr> </table> <table border="1"> <tr><th colspan="2">Needle</th></tr> <tr><td>Length (mm)</td><td>6.4</td></tr> <tr><td>Curve</td><td>3/8</td></tr> <tr><td>Diam. (mm)</td><td>0.20</td></tr> </table>	Suture		Description	Polyglycolic Acid, Violet Braid	Length (cm)	30	Size	9-0 (0.3 metric)	Needle		Length (mm)	6.4	Curve	3/8	Diam. (mm)	0.20
Suture																			
Description	Polyglycolic Acid, Violet Braid																		
Length (cm)	30																		
Size	9-0 (0.3 metric)																		
Needle																			
Length (mm)	6.4																		
Curve	3/8																		
Diam. (mm)	0.20																		
AXI4043	PGA Suture, Spatula Double-armed suture, measures 30cm in length. Spatula needle, measures 6.0mm in length, 1/2 curve, and 0.15mm in diameter.	<p>Double-Armed Spatula</p>	<table border="1"> <tr><th colspan="2">Suture</th></tr> <tr><td>Description</td><td>Polyglycolic Acid, Violet Braid</td></tr> <tr><td>Length (cm)</td><td>30</td></tr> <tr><td>Size</td><td>9-0 (0.3 metric)</td></tr> </table> <table border="1"> <tr><th colspan="2">Needle</th></tr> <tr><td>Length (mm)</td><td>6.0</td></tr> <tr><td>Curve</td><td>1/2</td></tr> <tr><td>Diam. (mm)</td><td>0.15</td></tr> </table>	Suture		Description	Polyglycolic Acid, Violet Braid	Length (cm)	30	Size	9-0 (0.3 metric)	Needle		Length (mm)	6.0	Curve	1/2	Diam. (mm)	0.15
Suture																			
Description	Polyglycolic Acid, Violet Braid																		
Length (cm)	30																		
Size	9-0 (0.3 metric)																		
Needle																			
Length (mm)	6.0																		
Curve	1/2																		
Diam. (mm)	0.15																		
AXI4042	PGA Suture, Spatula Single-armed suture, measures 30cm in length. Spatula needle, measures 6.0mm in length, 1/2 curve, and 0.15mm in diameter.	<p>Single-Armed Spatula</p>	<table border="1"> <tr><th colspan="2">Suture</th></tr> <tr><td>Description</td><td>Polyglycolic Acid, Violet Braid</td></tr> <tr><td>Length (cm)</td><td>30</td></tr> <tr><td>Size</td><td>9-0 (0.3 metric)</td></tr> </table> <table border="1"> <tr><th colspan="2">Needle</th></tr> <tr><td>Length (mm)</td><td>6.0</td></tr> <tr><td>Curve</td><td>1/2</td></tr> <tr><td>Diam. (mm)</td><td>0.15</td></tr> </table>	Suture		Description	Polyglycolic Acid, Violet Braid	Length (cm)	30	Size	9-0 (0.3 metric)	Needle		Length (mm)	6.0	Curve	1/2	Diam. (mm)	0.15
Suture																			
Description	Polyglycolic Acid, Violet Braid																		
Length (cm)	30																		
Size	9-0 (0.3 metric)																		
Needle																			
Length (mm)	6.0																		
Curve	1/2																		
Diam. (mm)	0.15																		

Sutures 8-0 Polyglycolic Acid

Peters and Mani brand 8-0, violet braided, polyglycolic acid sutures with single and double arms. Spatula, trape spatula, and taper point needles ranging in length, curve, and diameter. Mani and Peters brand sutures are high-quality products with strong and break-resistant needles. Sold 12 per box.



AB-2090	PGA Suture, Spatula Double-armed suture, measures 30cm in length. Trape spatula needle, measures 6.5mm in length, 3/8 curve, and 0.20mm in diameter. Manufactured by Mani.	<p>Double-Armed Trape Spatula</p>	<table border="1"> <tr><th colspan="2">Suture</th></tr> <tr><td>Description</td><td>Polyglycolic Acid, Violet Braid</td></tr> <tr><td>Length (cm)</td><td>30</td></tr> <tr><td>Size</td><td>8-0 (0.4 metric)</td></tr> </table> <table border="1"> <tr><th colspan="2">Needle</th></tr> <tr><td>Length (mm)</td><td>6.5</td></tr> <tr><td>Curve</td><td>3/8</td></tr> <tr><td>Diam. (mm)</td><td>0.20</td></tr> </table>	Suture		Description	Polyglycolic Acid, Violet Braid	Length (cm)	30	Size	8-0 (0.4 metric)	Needle		Length (mm)	6.5	Curve	3/8	Diam. (mm)	0.20
Suture																			
Description	Polyglycolic Acid, Violet Braid																		
Length (cm)	30																		
Size	8-0 (0.4 metric)																		
Needle																			
Length (mm)	6.5																		
Curve	3/8																		
Diam. (mm)	0.20																		
AB-8109	PGA Suture, Taper Point Single-armed suture, measures 30cm in length. Taper point needle, measures 6.4mm in length, 3/8 curve, and 0.40mm in diameter. Manufactured by Peters.	<p>Single-Armed Taper Point</p>	<table border="1"> <tr><th colspan="2">Suture</th></tr> <tr><td>Description</td><td>Polyglycolic Acid, Violet Braid</td></tr> <tr><td>Length (cm)</td><td>30</td></tr> <tr><td>Size</td><td>8-0 (0.4 metric)</td></tr> </table> <table border="1"> <tr><th colspan="2">Needle</th></tr> <tr><td>Length (mm)</td><td>6.4</td></tr> <tr><td>Curve</td><td>3/8</td></tr> <tr><td>Diam. (mm)</td><td>0.40</td></tr> </table>	Suture		Description	Polyglycolic Acid, Violet Braid	Length (cm)	30	Size	8-0 (0.4 metric)	Needle		Length (mm)	6.4	Curve	3/8	Diam. (mm)	0.40
Suture																			
Description	Polyglycolic Acid, Violet Braid																		
Length (cm)	30																		
Size	8-0 (0.4 metric)																		
Needle																			
Length (mm)	6.4																		
Curve	3/8																		
Diam. (mm)	0.40																		
AB-8112	PGASuture, Spatula Double-armed suture, measures 30cm in length. Spatula needle, measures 6.4mm in length, 3/8 curve, and 0.40mm in diameter. Manufactured by Peters.	<p>Double-Armed Spatula</p>	<table border="1"> <tr><th colspan="2">Suture</th></tr> <tr><td>Description</td><td>Polyglycolic Acid, Violet Braid</td></tr> <tr><td>Length (cm)</td><td>30</td></tr> <tr><td>Size</td><td>8-0 (0.4 metric)</td></tr> </table> <table border="1"> <tr><th colspan="2">Needle</th></tr> <tr><td>Length (mm)</td><td>6.4</td></tr> <tr><td>Curve</td><td>3/8</td></tr> <tr><td>Diam. (mm)</td><td>0.40</td></tr> </table>	Suture		Description	Polyglycolic Acid, Violet Braid	Length (cm)	30	Size	8-0 (0.4 metric)	Needle		Length (mm)	6.4	Curve	3/8	Diam. (mm)	0.40
Suture																			
Description	Polyglycolic Acid, Violet Braid																		
Length (cm)	30																		
Size	8-0 (0.4 metric)																		
Needle																			
Length (mm)	6.4																		
Curve	3/8																		
Diam. (mm)	0.40																		

POLYGLYCOLIC ACID

Item # Description Image

Sutures 7-0 Polyglycolic Acid

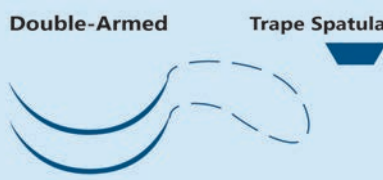
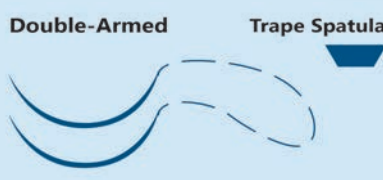
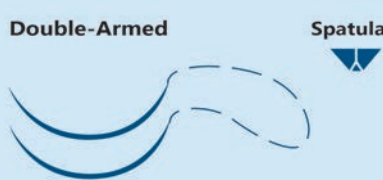
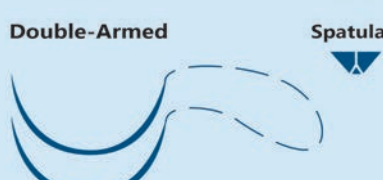
Peters and Mani brand 7-0, violet braided, polyglycolic acid sutures with single and double arms. Spatula and trape spatula needles ranging in length, curve, and diameter. Mani and Peters brand sutures are high-quality products with strong and break-resistant needles. Sold 12 per box.

AB-2091	PGA Suture, Trape Spatula Double-armed suture, measures 30cm in length. Trape spatula needle, measures 6.5mm in length, 3/8 curve, and 0.20mm in diameter. Manufactured by Mani.	 <p>Double-Armed Trape Spatula</p>	<table border="1"> <thead> <tr> <th colspan="2">Suture</th> </tr> </thead> <tbody> <tr> <td>Description</td> <td>Polyglycolic Acid, Violet Braid</td> </tr> <tr> <td>Length (cm)</td> <td>30</td> </tr> <tr> <td>Size</td> <td>7-0 (0.5 metric)</td> </tr> </tbody> </table> <table border="1"> <thead> <tr> <th colspan="2">Needle</th> </tr> </thead> <tbody> <tr> <td>Length (mm)</td> <td>6.5</td> </tr> <tr> <td>Curve</td> <td>3/8</td> </tr> <tr> <td>Diam. (mm)</td> <td>0.20</td> </tr> </tbody> </table>	Suture		Description	Polyglycolic Acid, Violet Braid	Length (cm)	30	Size	7-0 (0.5 metric)	Needle		Length (mm)	6.5	Curve	3/8	Diam. (mm)	0.20
Suture																			
Description	Polyglycolic Acid, Violet Braid																		
Length (cm)	30																		
Size	7-0 (0.5 metric)																		
Needle																			
Length (mm)	6.5																		
Curve	3/8																		
Diam. (mm)	0.20																		
AB-2092	PGA Suture, Trape Spatula Double-armed suture, measures 45cm in length. Trape spatula needle, measures 5.5mm in length, 7/16 curve, and 0.20mm in diameter. Manufactured by Mani.	 <p>Double-Armed Trape Spatula</p>	<table border="1"> <thead> <tr> <th colspan="2">Suture</th> </tr> </thead> <tbody> <tr> <td>Description</td> <td>Polyglycolic Acid, Violet Braid</td> </tr> <tr> <td>Length (cm)</td> <td>45</td> </tr> <tr> <td>Size</td> <td>7-0 (0.5 metric)</td> </tr> </tbody> </table> <table border="1"> <thead> <tr> <th colspan="2">Needle</th> </tr> </thead> <tbody> <tr> <td>Length (mm)</td> <td>5.5</td> </tr> <tr> <td>Curve</td> <td>7/16</td> </tr> <tr> <td>Diam. (mm)</td> <td>0.20</td> </tr> </tbody> </table>	Suture		Description	Polyglycolic Acid, Violet Braid	Length (cm)	45	Size	7-0 (0.5 metric)	Needle		Length (mm)	5.5	Curve	7/16	Diam. (mm)	0.20
Suture																			
Description	Polyglycolic Acid, Violet Braid																		
Length (cm)	45																		
Size	7-0 (0.5 metric)																		
Needle																			
Length (mm)	5.5																		
Curve	7/16																		
Diam. (mm)	0.20																		
AB-8111	PGA Suture, Spatula Double-armed suture, measures 45cm in length. Spatula needle, measures 6.4mm in length, 3/8 curve, and 0.50mm in diameter. Manufactured by Peters.	 <p>Double-Armed Spatula</p>	<table border="1"> <thead> <tr> <th colspan="2">Suture</th> </tr> </thead> <tbody> <tr> <td>Description</td> <td>Polyglycolic Acid, Violet Braid</td> </tr> <tr> <td>Length (cm)</td> <td>45</td> </tr> <tr> <td>Size</td> <td>7-0 (0.5 metric)</td> </tr> </tbody> </table> <table border="1"> <thead> <tr> <th colspan="2">Needle</th> </tr> </thead> <tbody> <tr> <td>Length (mm)</td> <td>6.4</td> </tr> <tr> <td>Curve</td> <td>3/8</td> </tr> <tr> <td>Diam. (mm)</td> <td>0.50</td> </tr> </tbody> </table>	Suture		Description	Polyglycolic Acid, Violet Braid	Length (cm)	45	Size	7-0 (0.5 metric)	Needle		Length (mm)	6.4	Curve	3/8	Diam. (mm)	0.50
Suture																			
Description	Polyglycolic Acid, Violet Braid																		
Length (cm)	45																		
Size	7-0 (0.5 metric)																		
Needle																			
Length (mm)	6.4																		
Curve	3/8																		
Diam. (mm)	0.50																		
AB-8126	PGA Suture, Spatula Double-armed suture, measures 30cm in length. Spatula needle, measures 6.0mm in length, 1/2 curve, and 0.50mm in diameter. Manufactured by Peters.	 <p>Double-Armed Spatula</p>	<table border="1"> <thead> <tr> <th colspan="2">Suture</th> </tr> </thead> <tbody> <tr> <td>Description</td> <td>Polyglycolic Acid, Violet Braid</td> </tr> <tr> <td>Length (cm)</td> <td>30</td> </tr> <tr> <td>Size</td> <td>7-0 (0.5 metric)</td> </tr> </tbody> </table> <table border="1"> <thead> <tr> <th colspan="2">Needle</th> </tr> </thead> <tbody> <tr> <td>Length (mm)</td> <td>6.0</td> </tr> <tr> <td>Curve</td> <td>1/2</td> </tr> <tr> <td>Diam. (mm)</td> <td>0.50</td> </tr> </tbody> </table>	Suture		Description	Polyglycolic Acid, Violet Braid	Length (cm)	30	Size	7-0 (0.5 metric)	Needle		Length (mm)	6.0	Curve	1/2	Diam. (mm)	0.50
Suture																			
Description	Polyglycolic Acid, Violet Braid																		
Length (cm)	30																		
Size	7-0 (0.5 metric)																		
Needle																			
Length (mm)	6.0																		
Curve	1/2																		
Diam. (mm)	0.50																		
AB-8102	PGA Suture, Spatula Single-armed suture, measures 30cm in length. Spatula needle, measures 6.4mm in length, 3/8 curve, and 0.50mm in diameter. Manufactured by Peters.	 <p>Single-Armed Spatula</p>	<table border="1"> <thead> <tr> <th colspan="2">Suture</th> </tr> </thead> <tbody> <tr> <td>Description</td> <td>Polyglycolic Acid, Violet Braid</td> </tr> <tr> <td>Length (cm)</td> <td>30</td> </tr> <tr> <td>Size</td> <td>7-0 (0.5 metric)</td> </tr> </tbody> </table> <table border="1"> <thead> <tr> <th colspan="2">Needle</th> </tr> </thead> <tbody> <tr> <td>Length (mm)</td> <td>6.4</td> </tr> <tr> <td>Curve</td> <td>3/8</td> </tr> <tr> <td>Diam. (mm)</td> <td>0.50</td> </tr> </tbody> </table>	Suture		Description	Polyglycolic Acid, Violet Braid	Length (cm)	30	Size	7-0 (0.5 metric)	Needle		Length (mm)	6.4	Curve	3/8	Diam. (mm)	0.50
Suture																			
Description	Polyglycolic Acid, Violet Braid																		
Length (cm)	30																		
Size	7-0 (0.5 metric)																		
Needle																			
Length (mm)	6.4																		
Curve	3/8																		
Diam. (mm)	0.50																		

Sutures 6-0 Polyglycolic Acid

Peters and Mani brand 6-0, violet braided, polyglycolic acid sutures with single and double arms. Dia spatula, trape spatula, spatula, and reverse cut needles ranging in length, curve, and diameter. Mani and Peters brand sutures are high-quality products with strong and break-resistant needles. Sold 12 per box.

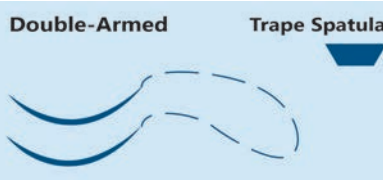
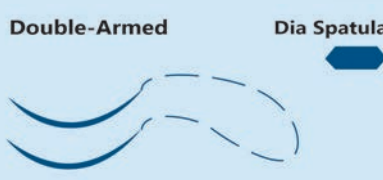
AB-2490	PGA Suture, Trape Spatula Double-armed suture, measures 45cm in length. Trape spatula needle, measures 6.5mm in length, 1/4 curve, and 0.24mm in diameter. Manufactured by Mani.	 <p>Double-Armed Trape Spatula</p>	<table border="1"> <thead> <tr> <th colspan="2">Suture</th> </tr> </thead> <tbody> <tr> <td>Description</td> <td>Polyglycolic Acid, Violet Braid</td> </tr> <tr> <td>Length (cm)</td> <td>45</td> </tr> <tr> <td>Size</td> <td>6-0 (0.7 metric)</td> </tr> </tbody> </table> <table border="1"> <thead> <tr> <th colspan="2">Needle</th> </tr> </thead> <tbody> <tr> <td>Length (mm)</td> <td>6.5</td> </tr> <tr> <td>Curve</td> <td>1/4</td> </tr> <tr> <td>Diam. (mm)</td> <td>0.24</td> </tr> </tbody> </table>	Suture		Description	Polyglycolic Acid, Violet Braid	Length (cm)	45	Size	6-0 (0.7 metric)	Needle		Length (mm)	6.5	Curve	1/4	Diam. (mm)	0.24
Suture																			
Description	Polyglycolic Acid, Violet Braid																		
Length (cm)	45																		
Size	6-0 (0.7 metric)																		
Needle																			
Length (mm)	6.5																		
Curve	1/4																		
Diam. (mm)	0.24																		
AB-2890	PGA Suture, Dia Spatula Double-armed suture, measures 45cm in length. Dia spatula needle, measures 8.5mm in length, 1/4 curve, and 0.28mm in diameter. Manufactured by Mani.	 <p>Double-Armed Dia Spatula</p>	<table border="1"> <thead> <tr> <th colspan="2">Suture</th> </tr> </thead> <tbody> <tr> <td>Description</td> <td>Polyglycolic Acid, Violet Braid</td> </tr> <tr> <td>Length (cm)</td> <td>45</td> </tr> <tr> <td>Size</td> <td>6-0 (0.7 metric)</td> </tr> </tbody> </table> <table border="1"> <thead> <tr> <th colspan="2">Needle</th> </tr> </thead> <tbody> <tr> <td>Length (mm)</td> <td>8.5</td> </tr> <tr> <td>Curve</td> <td>1/4</td> </tr> <tr> <td>Diam. (mm)</td> <td>0.28</td> </tr> </tbody> </table>	Suture		Description	Polyglycolic Acid, Violet Braid	Length (cm)	45	Size	6-0 (0.7 metric)	Needle		Length (mm)	8.5	Curve	1/4	Diam. (mm)	0.28
Suture																			
Description	Polyglycolic Acid, Violet Braid																		
Length (cm)	45																		
Size	6-0 (0.7 metric)																		
Needle																			
Length (mm)	8.5																		
Curve	1/4																		
Diam. (mm)	0.28																		

POLYGLYCOLIC ACID

Item #	Description	Image	Suture	Needle												
AB-8117	PGA Suture, Spatula Double-armed suture, measures 45cm in length. Spatula needle, measures 8.0mm in length, 1/4 curve, and 0.70mm in diameter. Manufactured by Peters.	Double-Armed Spatula 	<table border="1"> <tr><td>Description</td><td>Polyglycolic Acid, Violet Braid</td></tr> <tr><td>Length (cm)</td><td>45</td></tr> <tr><td>Size</td><td>6-0 (0.7 metric)</td></tr> </table>	Description	Polyglycolic Acid, Violet Braid	Length (cm)	45	Size	6-0 (0.7 metric)	<table border="1"> <tr><td>Length (mm)</td><td>8.0</td></tr> <tr><td>Curve</td><td>1/4</td></tr> <tr><td>Diam. (mm)</td><td>0.70</td></tr> </table>	Length (mm)	8.0	Curve	1/4	Diam. (mm)	0.70
Description	Polyglycolic Acid, Violet Braid															
Length (cm)	45															
Size	6-0 (0.7 metric)															
Length (mm)	8.0															
Curve	1/4															
Diam. (mm)	0.70															
AB-8127	PGA Suture, Spatula Double-armed suture, measures 30cm in length. Spatula needle, measures 6.4mm in length, 1/2 curve, and 0.70mm in diameter. Manufactured by Peters.	Double-Armed Spatula 	<table border="1"> <tr><td>Description</td><td>Polyglycolic Acid, Violet Braid</td></tr> <tr><td>Length (cm)</td><td>30</td></tr> <tr><td>Size</td><td>6-0 (0.7 metric)</td></tr> </table>	Description	Polyglycolic Acid, Violet Braid	Length (cm)	30	Size	6-0 (0.7 metric)	<table border="1"> <tr><td>Length (mm)</td><td>6.4</td></tr> <tr><td>Curve</td><td>1/2</td></tr> <tr><td>Diam. (mm)</td><td>0.70</td></tr> </table>	Length (mm)	6.4	Curve	1/2	Diam. (mm)	0.70
Description	Polyglycolic Acid, Violet Braid															
Length (cm)	30															
Size	6-0 (0.7 metric)															
Length (mm)	6.4															
Curve	1/2															
Diam. (mm)	0.70															
AB-8138	PGA Suture, Reverse Cut Single-armed suture, measures 45cm in length. Reverse cut needle, measures 12.0mm in length, 3/8 curve, and 0.70mm in diameter. Manufactured by Peters.	Single-Armed Reverse Cut 	<table border="1"> <tr><td>Description</td><td>Polyglycolic Acid, Violet Braid</td></tr> <tr><td>Length (cm)</td><td>45</td></tr> <tr><td>Size</td><td>6-0 (0.7 metric)</td></tr> </table>	Description	Polyglycolic Acid, Violet Braid	Length (cm)	45	Size	6-0 (0.7 metric)	<table border="1"> <tr><td>Length (mm)</td><td>12.0</td></tr> <tr><td>Curve</td><td>3/8</td></tr> <tr><td>Diam. (mm)</td><td>0.70</td></tr> </table>	Length (mm)	12.0	Curve	3/8	Diam. (mm)	0.70
Description	Polyglycolic Acid, Violet Braid															
Length (cm)	45															
Size	6-0 (0.7 metric)															
Length (mm)	12.0															
Curve	3/8															
Diam. (mm)	0.70															
AXI4045	PGA Suture, Reverse Cut Double-armed suture, measures 45cm in length. Reverse cut needle, measures 8.0mm in length, 3/8 curve, and 0.70mm in diameter. Manufactured by Peters.	Double-Armed Reverse Cut 	<table border="1"> <tr><td>Description</td><td>Polyglycolic Acid, Violet Braid</td></tr> <tr><td>Length (cm)</td><td>45</td></tr> <tr><td>Size</td><td>6-0 (0.7 metric)</td></tr> </table>	Description	Polyglycolic Acid, Violet Braid	Length (cm)	45	Size	6-0 (0.7 metric)	<table border="1"> <tr><td>Length (mm)</td><td>8.0</td></tr> <tr><td>Curve</td><td>3/8</td></tr> <tr><td>Diam. (mm)</td><td>0.70</td></tr> </table>	Length (mm)	8.0	Curve	3/8	Diam. (mm)	0.70
Description	Polyglycolic Acid, Violet Braid															
Length (cm)	45															
Size	6-0 (0.7 metric)															
Length (mm)	8.0															
Curve	3/8															
Diam. (mm)	0.70															

Sutures 5-0 Polyglycolic Acid



Peters and Mani brand 5-0, violet braided, polyglycolic acid sutures with single and double arms. Dia spatula, spatula, and reverse cut needles ranging in length, curve, and diameter. Mani and Peters brand sutures are high-quality products with strong and break-resistant needles. Sold 12 per box.

AB-3391	PGA Suture, Dia Spatula Double-armed suture, measures 45cm in length. Dia spatula needle, measures 8.5mm in length, 1/4 curve, and 0.33mm in diameter. Manufactured by Mani.	Double-Armed Dia Spatula 	<table border="1"> <tr><td>Description</td><td>Polyglycolic Acid, Violet Braid</td></tr> <tr><td>Length (cm)</td><td>45</td></tr> <tr><td>Size</td><td>5-0 (1.0 metric)</td></tr> </table>	Description	Polyglycolic Acid, Violet Braid	Length (cm)	45	Size	5-0 (1.0 metric)	<table border="1"> <tr><td>Length (mm)</td><td>8.5</td></tr> <tr><td>Curve</td><td>1/4</td></tr> <tr><td>Diam. (mm)</td><td>0.33</td></tr> </table>	Length (mm)	8.5	Curve	1/4	Diam. (mm)	0.33
Description	Polyglycolic Acid, Violet Braid															
Length (cm)	45															
Size	5-0 (1.0 metric)															
Length (mm)	8.5															
Curve	1/4															
Diam. (mm)	0.33															
AB-8123	PGA Suture, Spatula Double-armed suture, measures 45cm in length. Spatula needle, measures 8.0mm in length, 1/4 curve, and 1.0mm in diameter. Manufactured by Peters.	Double-Armed Spatula 	<table border="1"> <tr><td>Description</td><td>Polyglycolic Acid, Violet Braid</td></tr> <tr><td>Length (cm)</td><td>45</td></tr> <tr><td>Size</td><td>5-0 (1.0 metric)</td></tr> </table>	Description	Polyglycolic Acid, Violet Braid	Length (cm)	45	Size	5-0 (1.0 metric)	<table border="1"> <tr><td>Length (mm)</td><td>8.0</td></tr> <tr><td>Curve</td><td>1/4</td></tr> <tr><td>Diam. (mm)</td><td>1.0</td></tr> </table>	Length (mm)	8.0	Curve	1/4	Diam. (mm)	1.0
Description	Polyglycolic Acid, Violet Braid															
Length (cm)	45															
Size	5-0 (1.0 metric)															
Length (mm)	8.0															
Curve	1/4															
Diam. (mm)	1.0															
AXI4046	PGA Suture, Reverse Cut Single-armed suture, measures 45cm in length. Reverse cut needle, measures 16.0mm in length, 1/2 curve, and 1.0mm in diameter. Manufactured by Peters.	Single-Armed Reverse Cut 	<table border="1"> <tr><td>Description</td><td>Polyglycolic Acid, Violet Braid</td></tr> <tr><td>Length (cm)</td><td>45</td></tr> <tr><td>Size</td><td>5-0 (1.0 metric)</td></tr> </table>	Description	Polyglycolic Acid, Violet Braid	Length (cm)	45	Size	5-0 (1.0 metric)	<table border="1"> <tr><td>Length (mm)</td><td>16.0</td></tr> <tr><td>Curve</td><td>1/2</td></tr> <tr><td>Diam. (mm)</td><td>1.0</td></tr> </table>	Length (mm)	16.0	Curve	1/2	Diam. (mm)	1.0
Description	Polyglycolic Acid, Violet Braid															
Length (cm)	45															
Size	5-0 (1.0 metric)															
Length (mm)	16.0															
Curve	1/2															
Diam. (mm)	1.0															

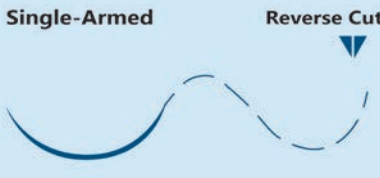
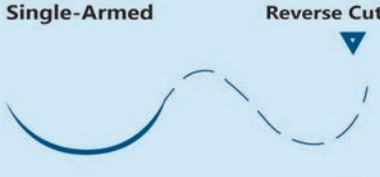
POLYPROPYLENE

Item #	Description	Image																
Sutures 6-0 Polypropylene																		
Ethicon and Surgical Specialties brand 6-0, blue polypropylene sutures with single arms. Reverse cut needles ranging in length and curve. Sold 12 per box.																		
AB-8697G	<p>Prolene Suture, Reverse Cut</p> <p>Single-armed suture, measures 45cm in length. Reverse cut needle, measures 11.0mm in length, and 3/8 curve. Manufactured by Ethicon.</p>	 <table border="1"> <thead> <tr> <th colspan="2">Suture</th> </tr> </thead> <tbody> <tr> <td>Description</td> <td>Polypropylene, Blue Mono</td> </tr> <tr> <td>Length (cm)</td> <td>45</td> </tr> <tr> <td>Size</td> <td>6-0 (0.7 metric)</td> </tr> </tbody> </table> <table border="1"> <thead> <tr> <th colspan="2">Needle</th> </tr> </thead> <tbody> <tr> <td>Length (mm)</td> <td>11.0</td> </tr> <tr> <td>Curve</td> <td>3/8</td> </tr> <tr> <td>Diam. (mm)</td> <td></td> </tr> </tbody> </table>	Suture		Description	Polypropylene, Blue Mono	Length (cm)	45	Size	6-0 (0.7 metric)	Needle		Length (mm)	11.0	Curve	3/8	Diam. (mm)	
Suture																		
Description	Polypropylene, Blue Mono																	
Length (cm)	45																	
Size	6-0 (0.7 metric)																	
Needle																		
Length (mm)	11.0																	
Curve	3/8																	
Diam. (mm)																		
AXI3144	<p>Prolene Suture, Reverse Cut</p> <p>Single-armed suture, measures 45cm in length. Reverse cut needle, measures 11.0mm in length, and 3/8 curve. Manufactured by Surgical Specialties.</p>	 <table border="1"> <thead> <tr> <th colspan="2">Suture</th> </tr> </thead> <tbody> <tr> <td>Description</td> <td>Polypropylene, Blue Mono</td> </tr> <tr> <td>Length (cm)</td> <td>45</td> </tr> <tr> <td>Size</td> <td>6-0 (0.7 metric)</td> </tr> </tbody> </table> <table border="1"> <thead> <tr> <th colspan="2">Needle</th> </tr> </thead> <tbody> <tr> <td>Length (mm)</td> <td>11.0</td> </tr> <tr> <td>Curve</td> <td>3/8</td> </tr> <tr> <td>Diam. (mm)</td> <td></td> </tr> </tbody> </table>	Suture		Description	Polypropylene, Blue Mono	Length (cm)	45	Size	6-0 (0.7 metric)	Needle		Length (mm)	11.0	Curve	3/8	Diam. (mm)	
Suture																		
Description	Polypropylene, Blue Mono																	
Length (cm)	45																	
Size	6-0 (0.7 metric)																	
Needle																		
Length (mm)	11.0																	
Curve	3/8																	
Diam. (mm)																		

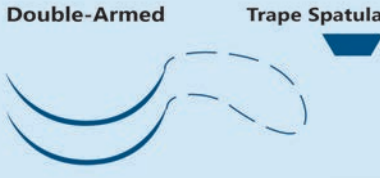
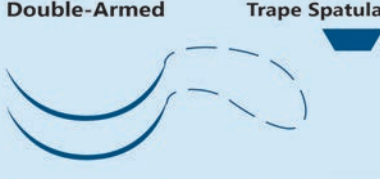
SILK



Item #	Description	Image																
Sutures 8-0 Silk																		
Mani brand 8-0, black braided, silk sutures with both single and double arms. Trape spatula needles ranging in length, curve, and diameter. Mani sutures are ideal for micro-suturing on the cornea and sclera during eye surgery. Ultimate sharpness is obtained through the "cross-lapped edge" technique giving each suture a fine and sharp tip ensuring minimally invasive wound closure. Mani hard fiber stainless steel is used to make strong and break-resistant needles. Sold 12 per box.																		
AB-1467	<p>Silk Suture, Trape Spatula</p> <p>Double-armed suture, measures 45cm in length. Trape spatula needle, measures 6.0mm in length, 3/8 curve, and 0.18mm in diameter.</p>	 <table border="1"> <thead> <tr> <th colspan="2">Suture</th> </tr> </thead> <tbody> <tr> <td>Description</td> <td>Silk, Black Braided</td> </tr> <tr> <td>Length (cm)</td> <td>45</td> </tr> <tr> <td>Size</td> <td>8-0 (0.4 metric)</td> </tr> </tbody> </table> <table border="1"> <thead> <tr> <th colspan="2">Needle</th> </tr> </thead> <tbody> <tr> <td>Length (mm)</td> <td>6.0</td> </tr> <tr> <td>Curve</td> <td>3/8</td> </tr> <tr> <td>Diam. (mm)</td> <td>0.18</td> </tr> </tbody> </table>	Suture		Description	Silk, Black Braided	Length (cm)	45	Size	8-0 (0.4 metric)	Needle		Length (mm)	6.0	Curve	3/8	Diam. (mm)	0.18
Suture																		
Description	Silk, Black Braided																	
Length (cm)	45																	
Size	8-0 (0.4 metric)																	
Needle																		
Length (mm)	6.0																	
Curve	3/8																	
Diam. (mm)	0.18																	
AB-2023	<p>Silk Suture, Trape Spatula</p> <p>Double-armed suture, measures 45cm in length. Trape spatula needle, measures 6.5mm in length, 3/8 curve, and 0.20mm in diameter.</p>	 <table border="1"> <thead> <tr> <th colspan="2">Suture</th> </tr> </thead> <tbody> <tr> <td>Description</td> <td>Silk, Black Braided</td> </tr> <tr> <td>Length (cm)</td> <td>45</td> </tr> <tr> <td>Size</td> <td>8-0 (0.4 metric)</td> </tr> </tbody> </table> <table border="1"> <thead> <tr> <th colspan="2">Needle</th> </tr> </thead> <tbody> <tr> <td>Length (mm)</td> <td>6.5</td> </tr> <tr> <td>Curve</td> <td>3/8</td> </tr> <tr> <td>Diam. (mm)</td> <td>0.20</td> </tr> </tbody> </table>	Suture		Description	Silk, Black Braided	Length (cm)	45	Size	8-0 (0.4 metric)	Needle		Length (mm)	6.5	Curve	3/8	Diam. (mm)	0.20
Suture																		
Description	Silk, Black Braided																	
Length (cm)	45																	
Size	8-0 (0.4 metric)																	
Needle																		
Length (mm)	6.5																	
Curve	3/8																	
Diam. (mm)	0.20																	
AB-2023S	<p>Silk Suture, Trape Spatula</p> <p>Single-armed suture, measures 20cm in length. Trape spatula needle, measures 6.5mm in length, 3/8 curve, and 0.20mm in diameter.</p>	 <table border="1"> <thead> <tr> <th colspan="2">Suture</th> </tr> </thead> <tbody> <tr> <td>Description</td> <td>Silk, Black Braided</td> </tr> <tr> <td>Length (cm)</td> <td>20</td> </tr> <tr> <td>Size</td> <td>8-0 (0.4 metric)</td> </tr> </tbody> </table> <table border="1"> <thead> <tr> <th colspan="2">Needle</th> </tr> </thead> <tbody> <tr> <td>Length (mm)</td> <td>6.5</td> </tr> <tr> <td>Curve</td> <td>3/8</td> </tr> <tr> <td>Diam. (mm)</td> <td>0.20</td> </tr> </tbody> </table>	Suture		Description	Silk, Black Braided	Length (cm)	20	Size	8-0 (0.4 metric)	Needle		Length (mm)	6.5	Curve	3/8	Diam. (mm)	0.20
Suture																		
Description	Silk, Black Braided																	
Length (cm)	20																	
Size	8-0 (0.4 metric)																	
Needle																		
Length (mm)	6.5																	
Curve	3/8																	
Diam. (mm)	0.20																	

SILK

Item #	Description	Image
--------	-------------	-------

Sutures 7-0 Silk

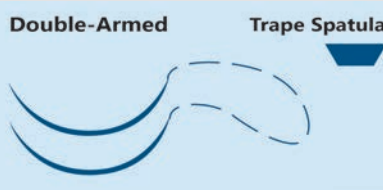
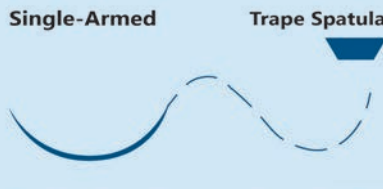
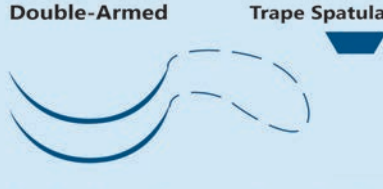
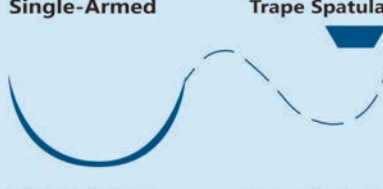
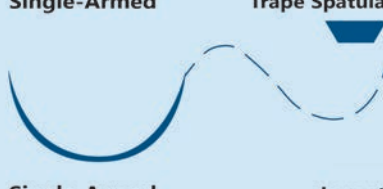
Mani brand 7-0, black or white braided, silk sutures with both single and double arms. Trape spatula and lancet needles ranging in length, curve, and diameter. Mani sutures are ideal for micro-suturing on the cornea and sclera during eye surgery. Ultimate sharpness is obtained through the "cross-lapped edge" technique giving each suture a fine and sharp tip ensuring minimally invasive wound closure. Mani hard fiber stainless steel is used to make strong and break-resistant needles. Sold 12 per box.

AB-2008	<p>Silk Suture, Trape Spatula</p> <p>Black braided, double-armed suture, measures 45cm in length. Trape spatula needle, measures 6.5mm in length, 3/8 curve, and 0.20mm in diameter.</p>	 <table border="1"> <thead> <tr> <th colspan="2">Suture</th> </tr> </thead> <tbody> <tr> <td>Description</td> <td>Silk, Black Braided</td> </tr> <tr> <td>Length (cm)</td> <td>45</td> </tr> <tr> <td>Size</td> <td>7-0 (0.5 metric)</td> </tr> </tbody> </table> <table border="1"> <thead> <tr> <th colspan="2">Needle</th> </tr> </thead> <tbody> <tr> <td>Length (mm)</td> <td>6.5</td> </tr> <tr> <td>Curve</td> <td>3/8</td> </tr> <tr> <td>Diam. (mm)</td> <td>0.20</td> </tr> </tbody> </table>	Suture		Description	Silk, Black Braided	Length (cm)	45	Size	7-0 (0.5 metric)	Needle		Length (mm)	6.5	Curve	3/8	Diam. (mm)	0.20
Suture																		
Description	Silk, Black Braided																	
Length (cm)	45																	
Size	7-0 (0.5 metric)																	
Needle																		
Length (mm)	6.5																	
Curve	3/8																	
Diam. (mm)	0.20																	
AB-2008S	<p>Silk Suture, Trape Spatula</p> <p>Black braided, single-armed suture, measures 30cm in length. Trape spatula needle, measures 6.5mm in length, 3/8 curve, and 0.20mm in diameter.</p>	 <table border="1"> <thead> <tr> <th colspan="2">Suture</th> </tr> </thead> <tbody> <tr> <td>Description</td> <td>Silk, Black Braided</td> </tr> <tr> <td>Length (cm)</td> <td>30</td> </tr> <tr> <td>Size</td> <td>7-0 (0.5 metric)</td> </tr> </tbody> </table> <table border="1"> <thead> <tr> <th colspan="2">Needle</th> </tr> </thead> <tbody> <tr> <td>Length (mm)</td> <td>6.5</td> </tr> <tr> <td>Curve</td> <td>3/8</td> </tr> <tr> <td>Diam. (mm)</td> <td>0.20</td> </tr> </tbody> </table>	Suture		Description	Silk, Black Braided	Length (cm)	30	Size	7-0 (0.5 metric)	Needle		Length (mm)	6.5	Curve	3/8	Diam. (mm)	0.20
Suture																		
Description	Silk, Black Braided																	
Length (cm)	30																	
Size	7-0 (0.5 metric)																	
Needle																		
Length (mm)	6.5																	
Curve	3/8																	
Diam. (mm)	0.20																	
AB-2063	<p>Silk Suture, Trape Spatula</p> <p>Black braided, double-armed suture, measures 30cm in length. Trape spatula needle, measures 6.5mm in length, 3/8 curve, and 0.20mm in diameter.</p>	 <table border="1"> <thead> <tr> <th colspan="2">Suture</th> </tr> </thead> <tbody> <tr> <td>Description</td> <td>Silk, Black Braided</td> </tr> <tr> <td>Length (cm)</td> <td>30</td> </tr> <tr> <td>Size</td> <td>7-0 (0.5 metric)</td> </tr> </tbody> </table> <table border="1"> <thead> <tr> <th colspan="2">Needle</th> </tr> </thead> <tbody> <tr> <td>Length (mm)</td> <td>6.5</td> </tr> <tr> <td>Curve</td> <td>3/8</td> </tr> <tr> <td>Diam. (mm)</td> <td>0.20</td> </tr> </tbody> </table>	Suture		Description	Silk, Black Braided	Length (cm)	30	Size	7-0 (0.5 metric)	Needle		Length (mm)	6.5	Curve	3/8	Diam. (mm)	0.20
Suture																		
Description	Silk, Black Braided																	
Length (cm)	30																	
Size	7-0 (0.5 metric)																	
Needle																		
Length (mm)	6.5																	
Curve	3/8																	
Diam. (mm)	0.20																	
AB-2062S	<p>Silk Suture, Trape Spatula</p> <p>Black braided, single-armed suture, measures 45cm in length. Trape spatula needle, measures 8.0mm in length, 1/2 curve, and 0.20mm in diameter.</p>	 <table border="1"> <thead> <tr> <th colspan="2">Suture</th> </tr> </thead> <tbody> <tr> <td>Description</td> <td>Silk, Black Braided</td> </tr> <tr> <td>Length (cm)</td> <td>45</td> </tr> <tr> <td>Size</td> <td>7-0 (0.5 metric)</td> </tr> </tbody> </table> <table border="1"> <thead> <tr> <th colspan="2">Needle</th> </tr> </thead> <tbody> <tr> <td>Length (mm)</td> <td>8.0</td> </tr> <tr> <td>Curve</td> <td>1/2</td> </tr> <tr> <td>Diam. (mm)</td> <td>0.20</td> </tr> </tbody> </table>	Suture		Description	Silk, Black Braided	Length (cm)	45	Size	7-0 (0.5 metric)	Needle		Length (mm)	8.0	Curve	1/2	Diam. (mm)	0.20
Suture																		
Description	Silk, Black Braided																	
Length (cm)	45																	
Size	7-0 (0.5 metric)																	
Needle																		
Length (mm)	8.0																	
Curve	1/2																	
Diam. (mm)	0.20																	
AB-2068S	<p>Silk Suture, Trape Spatula</p> <p>White braided, single-armed suture, measures 45cm in length. Trape spatula needle, measures 8.0mm in length, 1/2 curve, and 0.20mm in diameter.</p>	 <table border="1"> <thead> <tr> <th colspan="2">Suture</th> </tr> </thead> <tbody> <tr> <td>Description</td> <td>Silk, White Braided</td> </tr> <tr> <td>Length (cm)</td> <td>45</td> </tr> <tr> <td>Size</td> <td>7-0 (0.5 metric)</td> </tr> </tbody> </table> <table border="1"> <thead> <tr> <th colspan="2">Needle</th> </tr> </thead> <tbody> <tr> <td>Length (mm)</td> <td>8.0</td> </tr> <tr> <td>Curve</td> <td>1/2</td> </tr> <tr> <td>Diam. (mm)</td> <td>0.20</td> </tr> </tbody> </table>	Suture		Description	Silk, White Braided	Length (cm)	45	Size	7-0 (0.5 metric)	Needle		Length (mm)	8.0	Curve	1/2	Diam. (mm)	0.20
Suture																		
Description	Silk, White Braided																	
Length (cm)	45																	
Size	7-0 (0.5 metric)																	
Needle																		
Length (mm)	8.0																	
Curve	1/2																	
Diam. (mm)	0.20																	
AB-2860S	<p>Silk Suture, Lancet</p> <p>Black braided, single-armed suture, measures 50cm in length. Lancet needle, measures 7.0mm in length, 3/8 curve, and 0.28mm in diameter.</p>	 <table border="1"> <thead> <tr> <th colspan="2">Suture</th> </tr> </thead> <tbody> <tr> <td>Description</td> <td>Silk, Black Braided</td> </tr> <tr> <td>Length (cm)</td> <td>50</td> </tr> <tr> <td>Size</td> <td>7-0 (0.5 metric)</td> </tr> </tbody> </table> <table border="1"> <thead> <tr> <th colspan="2">Needle</th> </tr> </thead> <tbody> <tr> <td>Length (mm)</td> <td>7.0</td> </tr> <tr> <td>Curve</td> <td>3/8</td> </tr> <tr> <td>Diam. (mm)</td> <td>0.28</td> </tr> </tbody> </table>	Suture		Description	Silk, Black Braided	Length (cm)	50	Size	7-0 (0.5 metric)	Needle		Length (mm)	7.0	Curve	3/8	Diam. (mm)	0.28
Suture																		
Description	Silk, Black Braided																	
Length (cm)	50																	
Size	7-0 (0.5 metric)																	
Needle																		
Length (mm)	7.0																	
Curve	3/8																	
Diam. (mm)	0.28																	

SILK

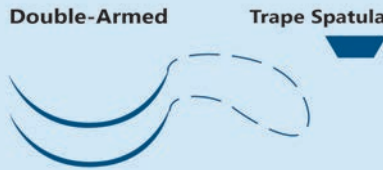
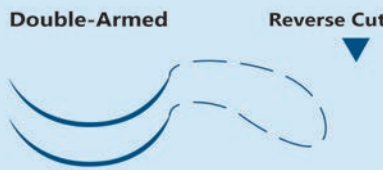
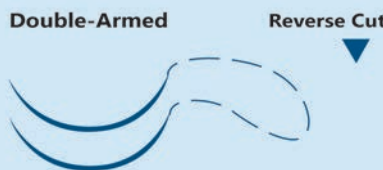
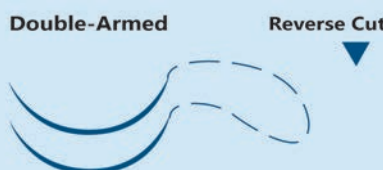
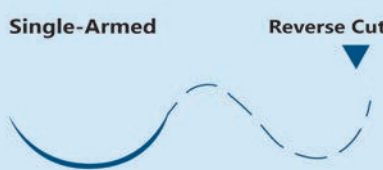
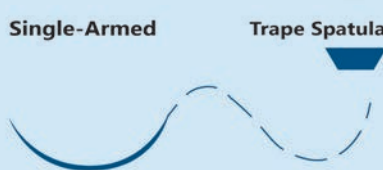
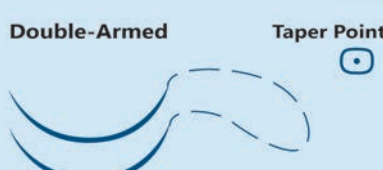
Item #	Description	Image																
Sutures 6-0 Silk																		
AB-2801	<p>Silk Suture, Trape Spatula</p> <p>Double-armed suture, measures 45cm in length. Trape spatula needle, measures 6.5mm in length, 3/8 curve, and 0.28mm in diameter.</p>	 <table border="1"> <thead> <tr> <th colspan="2">Suture</th> </tr> </thead> <tbody> <tr> <td>Description</td> <td>Silk, Black Braided</td> </tr> <tr> <td>Length (cm)</td> <td>45</td> </tr> <tr> <td>Size</td> <td>6-0 (0.7 metric)</td> </tr> </tbody> </table> <table border="1"> <thead> <tr> <th colspan="2">Needle</th> </tr> </thead> <tbody> <tr> <td>Length (mm)</td> <td>6.5</td> </tr> <tr> <td>Curve</td> <td>3/8</td> </tr> <tr> <td>Diam. (mm)</td> <td>0.28</td> </tr> </tbody> </table>	Suture		Description	Silk, Black Braided	Length (cm)	45	Size	6-0 (0.7 metric)	Needle		Length (mm)	6.5	Curve	3/8	Diam. (mm)	0.28
Suture																		
Description	Silk, Black Braided																	
Length (cm)	45																	
Size	6-0 (0.7 metric)																	
Needle																		
Length (mm)	6.5																	
Curve	3/8																	
Diam. (mm)	0.28																	
AB-2805	<p>Silk Suture, Reverse Cut</p> <p>Double-armed suture, measures 45cm in length. Reverse cut needle, measures 8.0mm in length, 5/16 curve, and 0.28mm in diameter.</p>	 <table border="1"> <thead> <tr> <th colspan="2">Suture</th> </tr> </thead> <tbody> <tr> <td>Description</td> <td>Silk, Black Braided</td> </tr> <tr> <td>Length (cm)</td> <td>45</td> </tr> <tr> <td>Size</td> <td>6-0 (0.7 metric)</td> </tr> </tbody> </table> <table border="1"> <thead> <tr> <th colspan="2">Needle</th> </tr> </thead> <tbody> <tr> <td>Length (mm)</td> <td>8.0</td> </tr> <tr> <td>Curve</td> <td>5/16</td> </tr> <tr> <td>Diam. (mm)</td> <td>0.28</td> </tr> </tbody> </table>	Suture		Description	Silk, Black Braided	Length (cm)	45	Size	6-0 (0.7 metric)	Needle		Length (mm)	8.0	Curve	5/16	Diam. (mm)	0.28
Suture																		
Description	Silk, Black Braided																	
Length (cm)	45																	
Size	6-0 (0.7 metric)																	
Needle																		
Length (mm)	8.0																	
Curve	5/16																	
Diam. (mm)	0.28																	
AB-2853	<p>Silk Suture, Reverse Cut</p> <p>Double-armed suture, measures 45cm in length. Reverse cut needle, measures 7.0mm in length, 3/8 curve, and 0.28mm in diameter.</p>	 <table border="1"> <thead> <tr> <th colspan="2">Suture</th> </tr> </thead> <tbody> <tr> <td>Description</td> <td>Silk, Black Braided</td> </tr> <tr> <td>Length (cm)</td> <td>45</td> </tr> <tr> <td>Size</td> <td>6-0 (0.7 metric)</td> </tr> </tbody> </table> <table border="1"> <thead> <tr> <th colspan="2">Needle</th> </tr> </thead> <tbody> <tr> <td>Length (mm)</td> <td>7.0</td> </tr> <tr> <td>Curve</td> <td>3/8</td> </tr> <tr> <td>Diam. (mm)</td> <td>0.28</td> </tr> </tbody> </table>	Suture		Description	Silk, Black Braided	Length (cm)	45	Size	6-0 (0.7 metric)	Needle		Length (mm)	7.0	Curve	3/8	Diam. (mm)	0.28
Suture																		
Description	Silk, Black Braided																	
Length (cm)	45																	
Size	6-0 (0.7 metric)																	
Needle																		
Length (mm)	7.0																	
Curve	3/8																	
Diam. (mm)	0.28																	
AB-3305	<p>Silk Suture, Reverse Cut</p> <p>Double-armed suture, measures 45cm in length. Reverse cut needle, measures 11.0mm in length, 3/8 curve, and 0.33mm in diameter.</p>	 <table border="1"> <thead> <tr> <th colspan="2">Suture</th> </tr> </thead> <tbody> <tr> <td>Description</td> <td>Silk, Black Braided</td> </tr> <tr> <td>Length (cm)</td> <td>45</td> </tr> <tr> <td>Size</td> <td>6-0 (0.7 metric)</td> </tr> </tbody> </table> <table border="1"> <thead> <tr> <th colspan="2">Needle</th> </tr> </thead> <tbody> <tr> <td>Length (mm)</td> <td>11.0</td> </tr> <tr> <td>Curve</td> <td>3/8</td> </tr> <tr> <td>Diam. (mm)</td> <td>0.33</td> </tr> </tbody> </table>	Suture		Description	Silk, Black Braided	Length (cm)	45	Size	6-0 (0.7 metric)	Needle		Length (mm)	11.0	Curve	3/8	Diam. (mm)	0.33
Suture																		
Description	Silk, Black Braided																	
Length (cm)	45																	
Size	6-0 (0.7 metric)																	
Needle																		
Length (mm)	11.0																	
Curve	3/8																	
Diam. (mm)	0.33																	
AB-3305S	<p>Silk Suture, Reverse Cut</p> <p>Single-armed suture, measures 45cm in length. Reverse cut needle, measures 11.0mm in length, 3/8 curve, and 0.33mm in diameter.</p>	 <table border="1"> <thead> <tr> <th colspan="2">Suture</th> </tr> </thead> <tbody> <tr> <td>Description</td> <td>Silk, Black Braided</td> </tr> <tr> <td>Length (cm)</td> <td>45</td> </tr> <tr> <td>Size</td> <td>6-0 (0.7 metric)</td> </tr> </tbody> </table> <table border="1"> <thead> <tr> <th colspan="2">Needle</th> </tr> </thead> <tbody> <tr> <td>Length (mm)</td> <td>11.0</td> </tr> <tr> <td>Curve</td> <td>3/8</td> </tr> <tr> <td>Diam. (mm)</td> <td>0.33</td> </tr> </tbody> </table>	Suture		Description	Silk, Black Braided	Length (cm)	45	Size	6-0 (0.7 metric)	Needle		Length (mm)	11.0	Curve	3/8	Diam. (mm)	0.33
Suture																		
Description	Silk, Black Braided																	
Length (cm)	45																	
Size	6-0 (0.7 metric)																	
Needle																		
Length (mm)	11.0																	
Curve	3/8																	
Diam. (mm)	0.33																	
AB-3354S	<p>Silk Suture, Trape Spatula</p> <p>Single-armed suture, measures 50cm in length. Trape spatula needle, measures 10.0mm in length, 3/8 curve, and 0.33mm in diameter.</p>	 <table border="1"> <thead> <tr> <th colspan="2">Suture</th> </tr> </thead> <tbody> <tr> <td>Description</td> <td>Silk, Black Braided</td> </tr> <tr> <td>Length (cm)</td> <td>50</td> </tr> <tr> <td>Size</td> <td>6-0 (0.7 metric)</td> </tr> </tbody> </table> <table border="1"> <thead> <tr> <th colspan="2">Needle</th> </tr> </thead> <tbody> <tr> <td>Length (mm)</td> <td>10.0</td> </tr> <tr> <td>Curve</td> <td>3/8</td> </tr> <tr> <td>Diam. (mm)</td> <td>0.33</td> </tr> </tbody> </table>	Suture		Description	Silk, Black Braided	Length (cm)	50	Size	6-0 (0.7 metric)	Needle		Length (mm)	10.0	Curve	3/8	Diam. (mm)	0.33
Suture																		
Description	Silk, Black Braided																	
Length (cm)	50																	
Size	6-0 (0.7 metric)																	
Needle																		
Length (mm)	10.0																	
Curve	3/8																	
Diam. (mm)	0.33																	
AB-3356	<p>Silk Suture, Taper Point</p> <p>Double-armed suture, measures 55cm in length. Taper point needle, measures 13.0mm in length, 3/8 curve, and 0.33mm in diameter.</p>	 <table border="1"> <thead> <tr> <th colspan="2">Suture</th> </tr> </thead> <tbody> <tr> <td>Description</td> <td>Silk, Black Braided</td> </tr> <tr> <td>Length (cm)</td> <td>55</td> </tr> <tr> <td>Size</td> <td>6-0 (0.7 metric)</td> </tr> </tbody> </table> <table border="1"> <thead> <tr> <th colspan="2">Needle</th> </tr> </thead> <tbody> <tr> <td>Length (mm)</td> <td>13.0</td> </tr> <tr> <td>Curve</td> <td>3/8</td> </tr> <tr> <td>Diam. (mm)</td> <td>0.33</td> </tr> </tbody> </table>	Suture		Description	Silk, Black Braided	Length (cm)	55	Size	6-0 (0.7 metric)	Needle		Length (mm)	13.0	Curve	3/8	Diam. (mm)	0.33
Suture																		
Description	Silk, Black Braided																	
Length (cm)	55																	
Size	6-0 (0.7 metric)																	
Needle																		
Length (mm)	13.0																	
Curve	3/8																	
Diam. (mm)	0.33																	

SILK

Item #	Description	Image	Suture	Needle												
AB-3366	Silk Suture, Lancet Double-armed suture, measures 55cm in length. Lancet needle, measures 10.0mm in length, 3/8 curve, and 0.33mm in diameter.	Double-Armed Lancet 	<table border="1"><tr><td>Description</td><td>Silk, Black Braided</td></tr><tr><td>Length (cm)</td><td>55</td></tr><tr><td>Size</td><td>6-0 (0.7 metric)</td></tr></table>	Description	Silk, Black Braided	Length (cm)	55	Size	6-0 (0.7 metric)	<table border="1"><tr><td>Length (mm)</td><td>10.0</td></tr><tr><td>Curve</td><td>3/8</td></tr><tr><td>Diam. (mm)</td><td>0.33</td></tr></table>	Length (mm)	10.0	Curve	3/8	Diam. (mm)	0.33
Description	Silk, Black Braided															
Length (cm)	55															
Size	6-0 (0.7 metric)															
Length (mm)	10.0															
Curve	3/8															
Diam. (mm)	0.33															
AB-2804	Silk Suture, Trape Spatula Double-armed suture, measures 45cm in length. Trape spatula needle, measures 5.5mm in length, 7/16 curve, and 0.28mm in diameter.	Double-Armed Trape Spatula 	<table border="1"><tr><td>Description</td><td>Silk, Black Braided</td></tr><tr><td>Length (cm)</td><td>45</td></tr><tr><td>Size</td><td>6-0 (0.7 metric)</td></tr></table>	Description	Silk, Black Braided	Length (cm)	45	Size	6-0 (0.7 metric)	<table border="1"><tr><td>Length (mm)</td><td>5.5</td></tr><tr><td>Curve</td><td>7/16</td></tr><tr><td>Diam. (mm)</td><td>0.28</td></tr></table>	Length (mm)	5.5	Curve	7/16	Diam. (mm)	0.28
Description	Silk, Black Braided															
Length (cm)	45															
Size	6-0 (0.7 metric)															
Length (mm)	5.5															
Curve	7/16															
Diam. (mm)	0.28															
AB-3353	Silk Suture, Cut Taper Double-armed suture, measures 55cm in length. Cut taper needle, measures 13.0mm in length, 3/8 curve, and 0.33mm in diameter.	Double-Armed Cut Taper 	<table border="1"><tr><td>Description</td><td>Silk, Black Braided</td></tr><tr><td>Length (cm)</td><td>55</td></tr><tr><td>Size</td><td>6-0 (0.7 metric)</td></tr></table>	Description	Silk, Black Braided	Length (cm)	55	Size	6-0 (0.7 metric)	<table border="1"><tr><td>Length (mm)</td><td>13.0</td></tr><tr><td>Curve</td><td>3/8</td></tr><tr><td>Diam. (mm)</td><td>0.33</td></tr></table>	Length (mm)	13.0	Curve	3/8	Diam. (mm)	0.33
Description	Silk, Black Braided															
Length (cm)	55															
Size	6-0 (0.7 metric)															
Length (mm)	13.0															
Curve	3/8															
Diam. (mm)	0.33															
AB-3850S	Silk Suture, Cut Taper Single-armed suture, measures 60cm in length. Cut taper needle, measures 14.0mm in length, 3/8 curve, and 0.38mm in diameter.	Single-Armed Cut Taper 	<table border="1"><tr><td>Description</td><td>Silk, Black Braided</td></tr><tr><td>Length (cm)</td><td>60</td></tr><tr><td>Size</td><td>6-0 (0.7 metric)</td></tr></table>	Description	Silk, Black Braided	Length (cm)	60	Size	6-0 (0.7 metric)	<table border="1"><tr><td>Length (mm)</td><td>14.0</td></tr><tr><td>Curve</td><td>3/8</td></tr><tr><td>Diam. (mm)</td><td>0.38</td></tr></table>	Length (mm)	14.0	Curve	3/8	Diam. (mm)	0.38
Description	Silk, Black Braided															
Length (cm)	60															
Size	6-0 (0.7 metric)															
Length (mm)	14.0															
Curve	3/8															
Diam. (mm)	0.38															

Sutures 5-0 Silk

Mani brand 5-0, black braided, silk sutures with both single and double arms. Lancet, reverse cut, and taper point needles ranging in length, curve, and diameter. Mani sutures are ideal for micro-suturing on the cornea and sclera during eye surgery. Ultimate sharpness is obtained through the "cross-lapped edge" technique giving each suture a fine and sharp tip ensuring minimally invasive wound closure. Mani hard fiber stainless steel is used to make strong and break-resistant needles. Sold 12 per box.

AB-3355	Silk Suture, Taper Point Double-armed suture, measures 45cm in length. Taper point needle, measures 13.0mm in length, 3/8 curve, and 0.33mm in diameter.	Double-Armed Taper Point 	<table border="1"><tr><td>Description</td><td>Silk, Black Braided</td></tr><tr><td>Length (cm)</td><td>45</td></tr><tr><td>Size</td><td>5-0 (1.0 metric)</td></tr></table>	Description	Silk, Black Braided	Length (cm)	45	Size	5-0 (1.0 metric)	<table border="1"><tr><td>Length (mm)</td><td>13.0</td></tr><tr><td>Curve</td><td>3/8</td></tr><tr><td>Diam. (mm)</td><td>0.33</td></tr></table>	Length (mm)	13.0	Curve	3/8	Diam. (mm)	0.33
Description	Silk, Black Braided															
Length (cm)	45															
Size	5-0 (1.0 metric)															
Length (mm)	13.0															
Curve	3/8															
Diam. (mm)	0.33															
AB-3355S	Silk Suture, Taper Point Single-armed suture, measures 30cm in length. Taper point needle, measures 13.0mm in length, 3/8 curve, and 0.33mm in diameter.	Single-Armed Taper Point 	<table border="1"><tr><td>Description</td><td>Silk, Black Braided</td></tr><tr><td>Length (cm)</td><td>30</td></tr><tr><td>Size</td><td>5-0 (1.0 metric)</td></tr></table>	Description	Silk, Black Braided	Length (cm)	30	Size	5-0 (1.0 metric)	<table border="1"><tr><td>Length (mm)</td><td>13.0</td></tr><tr><td>Curve</td><td>3/8</td></tr><tr><td>Diam. (mm)</td><td>0.33</td></tr></table>	Length (mm)	13.0	Curve	3/8	Diam. (mm)	0.33
Description	Silk, Black Braided															
Length (cm)	30															
Size	5-0 (1.0 metric)															
Length (mm)	13.0															
Curve	3/8															
Diam. (mm)	0.33															
AB-3358S	Silk Suture, Reverse Cut Single-armed suture, measures 50cm in length. Reverse cut needle, measures 13.0mm in length, 3/8 curve, and 0.33mm in diameter.	Single-Armed Reverse Cut 	<table border="1"><tr><td>Description</td><td>Silk, Black Braided</td></tr><tr><td>Length (cm)</td><td>50</td></tr><tr><td>Size</td><td>5-0 (1.0 metric)</td></tr></table>	Description	Silk, Black Braided	Length (cm)	50	Size	5-0 (1.0 metric)	<table border="1"><tr><td>Length (mm)</td><td>13.0</td></tr><tr><td>Curve</td><td>3/8</td></tr><tr><td>Diam. (mm)</td><td>0.33</td></tr></table>	Length (mm)	13.0	Curve	3/8	Diam. (mm)	0.33
Description	Silk, Black Braided															
Length (cm)	50															
Size	5-0 (1.0 metric)															
Length (mm)	13.0															
Curve	3/8															
Diam. (mm)	0.33															

SILK

Item #	Description	Image	Suture	Needle												
AB-3855S	Silk Suture, Taper Point Single-armed suture, measures 30cm in length. Taper point needle, measures 16.0mm in length, 3/8 curve, and 0.38mm in diameter.	Single-Armed Taper Point 	<table border="1"><tr><td>Description</td><td>Silk, Black Braided</td></tr><tr><td>Length (cm)</td><td>30</td></tr><tr><td>Size</td><td>5-0 (1.0 metric)</td></tr></table>	Description	Silk, Black Braided	Length (cm)	30	Size	5-0 (1.0 metric)	<table border="1"><tr><td>Length (mm)</td><td>16.0</td></tr><tr><td>Curve</td><td>3/8</td></tr><tr><td>Diam. (mm)</td><td>0.38</td></tr></table>	Length (mm)	16.0	Curve	3/8	Diam. (mm)	0.38
Description	Silk, Black Braided															
Length (cm)	30															
Size	5-0 (1.0 metric)															
Length (mm)	16.0															
Curve	3/8															
Diam. (mm)	0.38															
AB-4350S	Silk Suture, Reverse Cut Single-armed suture, measures 50cm in length. Reverse cut needle, measures 11.0mm in length, 3/8 curve, and 0.43mm in diameter.	Single-Armed Reverse Cut 	<table border="1"><tr><td>Description</td><td>Silk, Black Braided</td></tr><tr><td>Length (cm)</td><td>50</td></tr><tr><td>Size</td><td>5-0 (1.0 metric)</td></tr></table>	Description	Silk, Black Braided	Length (cm)	50	Size	5-0 (1.0 metric)	<table border="1"><tr><td>Length (mm)</td><td>11.0</td></tr><tr><td>Curve</td><td>3/8</td></tr><tr><td>Diam. (mm)</td><td>0.43</td></tr></table>	Length (mm)	11.0	Curve	3/8	Diam. (mm)	0.43
Description	Silk, Black Braided															
Length (cm)	50															
Size	5-0 (1.0 metric)															
Length (mm)	11.0															
Curve	3/8															
Diam. (mm)	0.43															
AB-3855	Silk Suture, Taper Point Double-armed suture, measures 60cm in length. Taper point needle, measures 16.0mm in length, 3/8 curve, and 0.38mm in diameter.	Double-Armed Taper Point 	<table border="1"><tr><td>Description</td><td>Silk, Black Braided</td></tr><tr><td>Length (cm)</td><td>60</td></tr><tr><td>Size</td><td>5-0 (1.0 metric)</td></tr></table>	Description	Silk, Black Braided	Length (cm)	60	Size	5-0 (1.0 metric)	<table border="1"><tr><td>Length (mm)</td><td>16.0</td></tr><tr><td>Curve</td><td>3/8</td></tr><tr><td>Diam. (mm)</td><td>0.38</td></tr></table>	Length (mm)	16.0	Curve	3/8	Diam. (mm)	0.38
Description	Silk, Black Braided															
Length (cm)	60															
Size	5-0 (1.0 metric)															
Length (mm)	16.0															
Curve	3/8															
Diam. (mm)	0.38															
AB-3856	Silk Suture, Lancet Double-armed suture, measures 50cm in length. Lancet needle, measures 11.0mm in length, 3/8 curve, and 0.38mm in diameter.	Double-Armed Lancet 	<table border="1"><tr><td>Description</td><td>Silk, Black Braided</td></tr><tr><td>Length (cm)</td><td>50</td></tr><tr><td>Size</td><td>5-0 (1.0 metric)</td></tr></table>	Description	Silk, Black Braided	Length (cm)	50	Size	5-0 (1.0 metric)	<table border="1"><tr><td>Length (mm)</td><td>11.0</td></tr><tr><td>Curve</td><td>3/8</td></tr><tr><td>Diam. (mm)</td><td>0.38</td></tr></table>	Length (mm)	11.0	Curve	3/8	Diam. (mm)	0.38
Description	Silk, Black Braided															
Length (cm)	50															
Size	5-0 (1.0 metric)															
Length (mm)	11.0															
Curve	3/8															
Diam. (mm)	0.38															
AB-3856S	Silk Suture, Lancet Single-armed suture, measures 50cm in length. Lancet needle, measures 11.0mm in length, 3/8 curve, and 0.38mm in diameter.	Single-Armed Lancet 	<table border="1"><tr><td>Description</td><td>Silk, Black Braided</td></tr><tr><td>Length (cm)</td><td>50</td></tr><tr><td>Size</td><td>5-0 (1.0 metric)</td></tr></table>	Description	Silk, Black Braided	Length (cm)	50	Size	5-0 (1.0 metric)	<table border="1"><tr><td>Length (mm)</td><td>11.0</td></tr><tr><td>Curve</td><td>3/8</td></tr><tr><td>Diam. (mm)</td><td>0.38</td></tr></table>	Length (mm)	11.0	Curve	3/8	Diam. (mm)	0.38
Description	Silk, Black Braided															
Length (cm)	50															
Size	5-0 (1.0 metric)															
Length (mm)	11.0															
Curve	3/8															
Diam. (mm)	0.38															

Sutures 4-0 Silk

Mani brand 4-0, black or white braided, silk sutures with both single and double arms. Taper point, reverse cut, cut taper, dia spatula, and lancet needles ranging in length, curve, and diameter. Mani sutures are ideal for micro-suturing on the cornea and sclera during eye surgery. Ultimate sharpness is obtained through the "cross-lapped edge" technique giving each suture a fine and sharp tip ensuring minimally invasive wound closure. Mani hard fiber stainless steel is used to make strong and break-resistant needles. Sold 12 per box.

AB-380I	Silk Suture, Taper Point Black braided, double-armed suture, measures 45cm in length. Taper point needle, measures 13.0mm in length, 3/8 curve, and 0.38mm in diameter.	Double-Armed Taper Point 	<table border="1"><tr><td>Description</td><td>Silk, Black Braided</td></tr><tr><td>Length (cm)</td><td>45</td></tr><tr><td>Size</td><td>4-0 (1.5 metric)</td></tr></table>	Description	Silk, Black Braided	Length (cm)	45	Size	4-0 (1.5 metric)	<table border="1"><tr><td>Length (mm)</td><td>13.0</td></tr><tr><td>Curve</td><td>3/8</td></tr><tr><td>Diam. (mm)</td><td>0.38</td></tr></table>	Length (mm)	13.0	Curve	3/8	Diam. (mm)	0.38
Description	Silk, Black Braided															
Length (cm)	45															
Size	4-0 (1.5 metric)															
Length (mm)	13.0															
Curve	3/8															
Diam. (mm)	0.38															
AB-380IS	Silk Suture, Taper Point Black braided, single-armed suture, measures 45cm in length. Taper point needle, measures 13.0mm in length, 3/8 curve, and 0.38mm in diameter.	Single-Armed Taper Point 	<table border="1"><tr><td>Description</td><td>Silk, Black Braided</td></tr><tr><td>Length (cm)</td><td>45</td></tr><tr><td>Size</td><td>4-0 (1.5 metric)</td></tr></table>	Description	Silk, Black Braided	Length (cm)	45	Size	4-0 (1.5 metric)	<table border="1"><tr><td>Length (mm)</td><td>13.0</td></tr><tr><td>Curve</td><td>3/8</td></tr><tr><td>Diam. (mm)</td><td>0.38</td></tr></table>	Length (mm)	13.0	Curve	3/8	Diam. (mm)	0.38
Description	Silk, Black Braided															
Length (cm)	45															
Size	4-0 (1.5 metric)															
Length (mm)	13.0															
Curve	3/8															
Diam. (mm)	0.38															

SILK

Item #	Description	Image												
AB-3851	<p>Silk Suture, Taper Point</p> <p>Black braided, double-armed suture, measures 55cm in length. Taper point needle, measures 13.0mm in length, 3/8 curve, and 0.38mm in diameter.</p>	<p>Suture</p> <table border="1"> <tr><td>Description</td><td>Silk, Black Braided</td></tr> <tr><td>Length (cm)</td><td>55</td></tr> <tr><td>Size</td><td>4-0 (1.5 metric)</td></tr> </table> <p>Needle</p> <table border="1"> <tr><td>Length (mm)</td><td>13.0</td></tr> <tr><td>Curve</td><td>3/8</td></tr> <tr><td>Diam. (mm)</td><td>0.38</td></tr> </table>	Description	Silk, Black Braided	Length (cm)	55	Size	4-0 (1.5 metric)	Length (mm)	13.0	Curve	3/8	Diam. (mm)	0.38
Description	Silk, Black Braided													
Length (cm)	55													
Size	4-0 (1.5 metric)													
Length (mm)	13.0													
Curve	3/8													
Diam. (mm)	0.38													
AB-4300	<p>Silk Suture, Reverse Cut</p> <p>Black braided, double-armed suture, measures 45cm in length. Reverse cut needle, measures 13.0mm in length, 7/16 curve, and 0.43mm in diameter.</p>	<p>Suture</p> <table border="1"> <tr><td>Description</td><td>Silk, Black Braided</td></tr> <tr><td>Length (cm)</td><td>45</td></tr> <tr><td>Size</td><td>4-0 (1.5 metric)</td></tr> </table> <p>Needle</p> <table border="1"> <tr><td>Length (mm)</td><td>13.0</td></tr> <tr><td>Curve</td><td>7/16</td></tr> <tr><td>Diam. (mm)</td><td>0.43</td></tr> </table>	Description	Silk, Black Braided	Length (cm)	45	Size	4-0 (1.5 metric)	Length (mm)	13.0	Curve	7/16	Diam. (mm)	0.43
Description	Silk, Black Braided													
Length (cm)	45													
Size	4-0 (1.5 metric)													
Length (mm)	13.0													
Curve	7/16													
Diam. (mm)	0.43													
AB-4351	<p>Silk Suture, Reverse Cut</p> <p>Black braided, double-armed suture, measures 50cm in length. Reverse cut needle, measures 13.0mm in length, 3/8 curve, and 0.43mm in diameter.</p>	<p>Suture</p> <table border="1"> <tr><td>Description</td><td>Silk, Black Braided</td></tr> <tr><td>Length (cm)</td><td>50</td></tr> <tr><td>Size</td><td>4-0 (1.5 metric)</td></tr> </table> <p>Needle</p> <table border="1"> <tr><td>Length (mm)</td><td>13.0</td></tr> <tr><td>Curve</td><td>3/8</td></tr> <tr><td>Diam. (mm)</td><td>0.43</td></tr> </table>	Description	Silk, Black Braided	Length (cm)	50	Size	4-0 (1.5 metric)	Length (mm)	13.0	Curve	3/8	Diam. (mm)	0.43
Description	Silk, Black Braided													
Length (cm)	50													
Size	4-0 (1.5 metric)													
Length (mm)	13.0													
Curve	3/8													
Diam. (mm)	0.43													
AB-4351S	<p>Silk Suture, Reverse Cut</p> <p>Black braided, single-armed suture, measures 50cm in length. Reverse cut needle, measures 13.0mm in length, 3/8 curve, and 0.43mm in diameter.</p>	<p>Suture</p> <table border="1"> <tr><td>Description</td><td>Silk, Black Braided</td></tr> <tr><td>Length (cm)</td><td>50</td></tr> <tr><td>Size</td><td>4-0 (1.5 metric)</td></tr> </table> <p>Needle</p> <table border="1"> <tr><td>Length (mm)</td><td>13.0</td></tr> <tr><td>Curve</td><td>3/8</td></tr> <tr><td>Diam. (mm)</td><td>0.43</td></tr> </table>	Description	Silk, Black Braided	Length (cm)	50	Size	4-0 (1.5 metric)	Length (mm)	13.0	Curve	3/8	Diam. (mm)	0.43
Description	Silk, Black Braided													
Length (cm)	50													
Size	4-0 (1.5 metric)													
Length (mm)	13.0													
Curve	3/8													
Diam. (mm)	0.43													
AB-5351	<p>Silk Suture, Taper Point</p> <p>Black braided, double-armed suture, measures 75cm in length. Taper point needle, measures 16.0mm in length, 1/2 curve, and 0.53mm in diameter.</p>	<p>Suture</p> <table border="1"> <tr><td>Description</td><td>Silk, Black Braided</td></tr> <tr><td>Length (cm)</td><td>75</td></tr> <tr><td>Size</td><td>4-0 (1.5 metric)</td></tr> </table> <p>Needle</p> <table border="1"> <tr><td>Length (mm)</td><td>16.0</td></tr> <tr><td>Curve</td><td>1/2</td></tr> <tr><td>Diam. (mm)</td><td>0.53</td></tr> </table>	Description	Silk, Black Braided	Length (cm)	75	Size	4-0 (1.5 metric)	Length (mm)	16.0	Curve	1/2	Diam. (mm)	0.53
Description	Silk, Black Braided													
Length (cm)	75													
Size	4-0 (1.5 metric)													
Length (mm)	16.0													
Curve	1/2													
Diam. (mm)	0.53													
AB-4302S	<p>Silk Suture, Cut Taper</p> <p>Black braided, single-armed suture, measures 75cm in length. Cut taper needle, measures 14.0mm in length, 3/8 curve, and 0.43mm in diameter.</p>	<p>Suture</p> <table border="1"> <tr><td>Description</td><td>Silk, Black Braided</td></tr> <tr><td>Length (cm)</td><td>75</td></tr> <tr><td>Size</td><td>4-0 (1.5 metric)</td></tr> </table> <p>Needle</p> <table border="1"> <tr><td>Length (mm)</td><td>14.0</td></tr> <tr><td>Curve</td><td>3/8</td></tr> <tr><td>Diam. (mm)</td><td>0.43</td></tr> </table>	Description	Silk, Black Braided	Length (cm)	75	Size	4-0 (1.5 metric)	Length (mm)	14.0	Curve	3/8	Diam. (mm)	0.43
Description	Silk, Black Braided													
Length (cm)	75													
Size	4-0 (1.5 metric)													
Length (mm)	14.0													
Curve	3/8													
Diam. (mm)	0.43													
AB-4359	<p>Silk Suture, Lancet</p> <p>Black braided, double-armed suture, measures 55cm in length. Lancet needle, measures 13.0mm in length, 3/8 curve, and 0.43mm in diameter.</p>	<p>Suture</p> <table border="1"> <tr><td>Description</td><td>Silk, Black Braided</td></tr> <tr><td>Length (cm)</td><td>55</td></tr> <tr><td>Size</td><td>4-0 (1.5 metric)</td></tr> </table> <p>Needle</p> <table border="1"> <tr><td>Length (mm)</td><td>13.0</td></tr> <tr><td>Curve</td><td>3/8</td></tr> <tr><td>Diam. (mm)</td><td>0.43</td></tr> </table>	Description	Silk, Black Braided	Length (cm)	55	Size	4-0 (1.5 metric)	Length (mm)	13.0	Curve	3/8	Diam. (mm)	0.43
Description	Silk, Black Braided													
Length (cm)	55													
Size	4-0 (1.5 metric)													
Length (mm)	13.0													
Curve	3/8													
Diam. (mm)	0.43													
AB-4359S	<p>Silk Suture, Lancet</p> <p>Black braided, single-armed suture, measures 50cm in length. Lancet needle, measures 13.0mm in length, 3/8 curve, and 0.43mm in diameter.</p>	<p>Suture</p> <table border="1"> <tr><td>Description</td><td>Silk, Black Braided</td></tr> <tr><td>Length (cm)</td><td>50</td></tr> <tr><td>Size</td><td>4-0 (1.5 metric)</td></tr> </table> <p>Needle</p> <table border="1"> <tr><td>Length (mm)</td><td>13.0</td></tr> <tr><td>Curve</td><td>3/8</td></tr> <tr><td>Diam. (mm)</td><td>0.43</td></tr> </table>	Description	Silk, Black Braided	Length (cm)	50	Size	4-0 (1.5 metric)	Length (mm)	13.0	Curve	3/8	Diam. (mm)	0.43
Description	Silk, Black Braided													
Length (cm)	50													
Size	4-0 (1.5 metric)													
Length (mm)	13.0													
Curve	3/8													
Diam. (mm)	0.43													

SILK

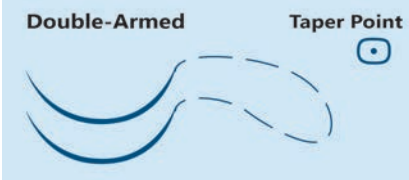
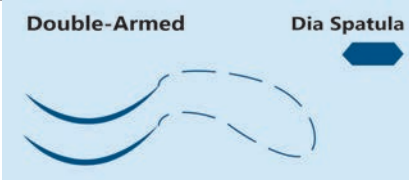
Item #	Description	Image																
AB-3857	<p>Silk Suture, Taper Point</p> <p>White braided, double-armed suture, measures 45cm in length. Taper point needle, measures 25.0mm in length, 7/16 curve, and 0.38mm in diameter.</p>	 <table border="1"> <thead> <tr> <th colspan="2">Suture</th> </tr> </thead> <tbody> <tr> <td>Description</td> <td>Silk, White Braided</td> </tr> <tr> <td>Length (cm)</td> <td>45</td> </tr> <tr> <td>Size</td> <td>4-0 (1.5 metric)</td> </tr> </tbody> </table> <table border="1"> <thead> <tr> <th colspan="2">Needle</th> </tr> </thead> <tbody> <tr> <td>Length (mm)</td> <td>25.0</td> </tr> <tr> <td>Curve</td> <td>7/16</td> </tr> <tr> <td>Diam. (mm)</td> <td>0.38</td> </tr> </tbody> </table>	Suture		Description	Silk, White Braided	Length (cm)	45	Size	4-0 (1.5 metric)	Needle		Length (mm)	25.0	Curve	7/16	Diam. (mm)	0.38
Suture																		
Description	Silk, White Braided																	
Length (cm)	45																	
Size	4-0 (1.5 metric)																	
Needle																		
Length (mm)	25.0																	
Curve	7/16																	
Diam. (mm)	0.38																	
AB-4360	<p>Silk Suture, Dia Spatula</p> <p>White braided, double-armed suture, measures 60cm in length. Dia spatula needle, measures 6.5mm in length, 1/4 curve, and 0.43mm in diameter.</p>	 <table border="1"> <thead> <tr> <th colspan="2">Suture</th> </tr> </thead> <tbody> <tr> <td>Description</td> <td>Silk, White Braided</td> </tr> <tr> <td>Length (cm)</td> <td>60</td> </tr> <tr> <td>Size</td> <td>4-0 (1.5 metric)</td> </tr> </tbody> </table> <table border="1"> <thead> <tr> <th colspan="2">Needle</th> </tr> </thead> <tbody> <tr> <td>Length (mm)</td> <td>6.5</td> </tr> <tr> <td>Curve</td> <td>1/4</td> </tr> <tr> <td>Diam. (mm)</td> <td>0.43</td> </tr> </tbody> </table>	Suture		Description	Silk, White Braided	Length (cm)	60	Size	4-0 (1.5 metric)	Needle		Length (mm)	6.5	Curve	1/4	Diam. (mm)	0.43
Suture																		
Description	Silk, White Braided																	
Length (cm)	60																	
Size	4-0 (1.5 metric)																	
Needle																		
Length (mm)	6.5																	
Curve	1/4																	
Diam. (mm)	0.43																	

Surgical Disposables

APPAREL

Item #	Description	Image
--------	-------------	-------

Exam Gown

Exam gowns are an efficient way to offer patients a high level of privacy during exams while saving your facility laundry expenses. These disposable gowns are blue in color and designed with the patient's comfort in mind, while staying at an affordable price. Non-sterile and latex-free. Sold 50 per box.

AXI5194

Large Exam Gown

Medline patient gown that is made from a multi-layer fabric. Can be worn with opening in the front or back and the tie is attached to the gown for a snug fit. Regular/large in size with short sleeves.



AXI2076

Universal Exam Gown

McKesson exam gown that is made from 3-ply tissue/poly/tissue. Comes with a waist belt and measures 30 x 42 inches and fits most adults. Sleeves are short with no cuffs.



Isolation and Fluid-Resistant Surgical Gown

McKesson Isolation and Fluid-Resistant Gowns are designed for comfort and flexibility of movement. They are made of a non-woven, durable material and feature elastic cuffs. These disposable gowns are non-sterile and are not made with natural rubber latex. Non-sterile, disposable.



AXI3284

X-Large Surgical Gown

McKesson Protective Procedure Gown is made from polyethylene-coated, spunbonded polypropylene. Gown is yellow, long sleeves with elastic cuffs that fit snugly under gloves, unisex, and x-large adult size. Full back with neck and waist ties that offer individual size adjustment. Sold 10 per bag.



APPAREL





Item #	Description	Image
AXI2077	<p>Universal Surgical Gown, Blue</p> <p>Medi-Pak Performance Fluid-Resistant Gown is made from polyethylene-coated, spunbonded polypropylene. Gown is blue, long sleeves with elastic cuffs that fit snugly under gloves, unisex, and adult unisize. Open back with neck and waist ties that offer individual size adjustment. Sold 50 per box.</p>	
AXII795	<p>Universal Surgical Gown, White</p> <p>Medi-Pak Performance Fluid-Resistant Gown is made from polyethylene-coated, spunbonded polypropylene. Gown is white, long sleeves with elastic cuffs that fit snugly under gloves, unisex, and adult unisize. Full back with neck and waist ties that offer individual size adjustment. Sold 10 per box.</p>	
AXI3328	<p>Universal Surgical Gown</p> <p>McKesson Fluid-Resistant Gown is made from polypropylene. Gown is yellow, long sleeves with elastic cuffs that fit snugly under gloves, unisex, and adult unisize. Full back with neck and waist ties that offer individual size adjustment. Sold 50 per box.</p>	

Non-Skid Shoe Cover

Blue, non-skid shoe covers offer improved floor traction while having an elastic opening that provides a snug comfortable fit. Made from spunbound polypropylene. Latex-free and non-skid.

AXI3364	<p>Sport Shoe Cover</p> <p>Medline shoe cover made from spunbound polypropylene that is a breathable, fluid-repellent material. Blue cover with an elastic band for closure. Sport size fits almost any athletic shoe. Sold 100 per box.</p>	
---------	---	--

APPAREL

Item #	Description	Image
AX11642	<p>Large Shoe Cover</p> <p>Medline shoe cover made from spunbound polypropylene that is a breathable, fluid-repellent material. Blue cover with an elastic band for closure. Regular/large size fits up to men's size 12 but is generously sized for full-coverage protection. Sold 100 per box.</p>	
AX11250	<p>X-Large Shoe Cover</p> <p>Medline shoe cover made from spunbound polypropylene that is a breathable, fluid-repellent material. Blue cover with an elastic band for closure. X-large size fits up to men's size 15 but is generously sized for full-coverage protection. Sold 100 per box.</p>	
AX0208	<p>X-Large Shoe Cover</p> <p>Medline shoe cover made from spunbound polypropylene that is a breathable, fluid-repellent material. Blue cover with an elastic band for closure. X-large size fits up to men's size 15 but is generously sized for full-coverage protection. Sold 200 per box.</p>	
AX10735	<p>Universal Shoe Cover</p> <p>Dynarex shoe cover made from spunbound polypropylene that is sewn together instead of glued and offers greater strength. Blue cover with an elastic band for closure. Universal in size, fitting shoes small to large. Non-conductive. Sold 100 per box.</p>	

APPAREL

Item #	Description	Image
--------	-------------	-------

Smooth Bottom Shoe Cover

Smooth covers are ideal for jobs that do not require a non-skid tread. Made from spunbound polypropylene that is sewn together instead of glued, offering greater strength. Latex-free. Dynarex blue shoe cover with an elastic band for a snug comfortable closure. Universal in size, fitting shoes small to large, non-conductive, and sold 100 per box.

AXI0388	Universal Shoe Cover	
---------	-----------------------------	--



McKesson Bouffant Cap

Bouffant cap made from non-sterile spunbound polypropylene that is lightweight but durable and permits increased airflow, keeping the wearer cool and comfortable during long surgical procedures. Latex-free. Blue cap with elastic band for closure. Sold 100 per box.

AXI4051	Large Bouffant Cap 21-inch large size.	
---------	--	---

AXI4488	X-Large Bouffant Cap 24-inch x-large size.
---------	--





Pro Series Bouffant Cap

Medline Pro Series Bouffant Caps comply with NFPA standards and are made from lightweight multi-ply polypropylene, which results in less linting. Double-stitched elastic band keeps caps flat and comfortable on the forehead. Latex-free. Butterfly printed cap with elastic band for closure. 24-inch large/regular size. Sold 500 per case.

AXI4349	Butterfly Bouffant Cap	
---------	-------------------------------	---



APPAREL

Item #	Description	Image
Single-Ply Bouffant Cap		
<p>Medline caps are made of single-ply spunbond polypropylene, which results in less linting and is latex-free. Caps comply with NFPA standards and have double-stitched elastic band for closure that keeps caps flat and comfortable on the forehead. Sold 100 per bag.</p>		
AXI0923	<p>Medium Bouffant Cap, Blue Blue cap, 21-inch medium size.</p>	
AXI0240	<p>Large Bouffant Cap, White White cap, 24-inch large/regular size.</p>	
AXII593	<p>Large Bouffant Cap, Blue Blue cap, 24-inch large/regular size.</p>	

APPAREL

Item #	Description	Image
Surgeon Cap		
Blue surgeon caps that feature traditional tie-on styling. Uses comfortable material that is ideal for extended wearing during surgeries. One size fits most. Sold 100 per box.		
AXI325I	<p>McKesson Surgeon Cap</p> <p>McKesson surgeon cap is made from blue scrim-reinforced, soft and absorbent material, with wide panel sides, ventilated crown, and adjustable fastening ties. Non-sterile and latex-free.</p>	
AXI53I4	<p>Cardinal Surgeon Cap</p> <p>Cardinal blue nonwoven cap features traditional tie-on styling, providing you with a comfortable fit without binding. Features absorbent non-sterile polyester top for breathability and comfort. Contains latex.</p>	
AXI1823	<p>Halyard Surgeon Cap</p> <p>Halyard surgeon cap is made from blue Kaycel material, and has adjustable fastening ties. Best suited for use in situations where there is no fluid contamination anticipated. Non-sterile.</p>	

APPAREL

Item #	Description	Image
--------	-------------	-------

Surgical Gown

These surgical gowns are extremely comfortable and provide the right level of protection during surgeries.

AXI5490

Small Surgical Gown

Halyard sterile surgical gown is made from polypropylene, which is a low-linting fabric. Gown is blue, long sleeve, and small adult in size. Includes towel, knit cuffs, closed back, and adjustable neckline with 3-snap closure. Sold 34 per box.



AXI0502

Large Surgical Gown

Halyard sterile surgical gown is made from polypropylene, which is a low-linting fabric. Gown is blue, long sleeve, non-reinforced, and large adult in size. Includes towel, knit cuffs, closed back, and adjustable neckline with 2-snap closure. Sold 36 per box.

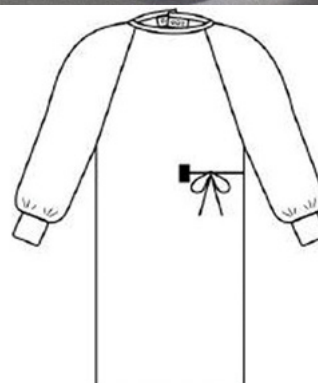

AXI4906

Large Surgical Gown

The Aurora line provides an unbeatable combination of extreme comfort and high protection. No compromise is necessary with a premium blue fabric that's also incredibly strong. The fabric's high hydrostatic head protects the wearer, and its extreme breathability leaves the wearer feeling cool and unrestricted during procedures. AAMI level 3 protection. The gown is sterile, large in size, and closes with a hook and loop. Sold 30 per box.

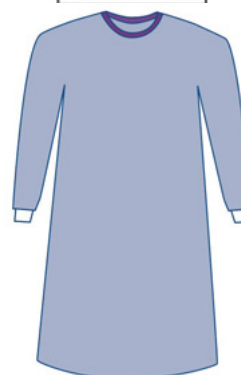

AXI3262

Large Surgical Gown





Astound sterile surgical gown is made from 3-layer microfiber, which is classified as AAMI level 3. Gown is blue, non-reinforced, long sleeve, and large adult in size. Includes towel, knit cuffs, closed back, and side tie closure. Sold 20 per box.



APPAREL

Item #	Description	Image
AXI2039	<p>X-Large Surgical Gown</p> <p>Halyard sterile surgical gown is made from polypropylene, which is a low-linting fabric. Gown is blue, long sleeve, and x-large adult in size. Includes towel, knit cuffs, closed back, and adjustable neckline with 3-snap closure. Sold 30 per box.</p>	

CAUTERIES

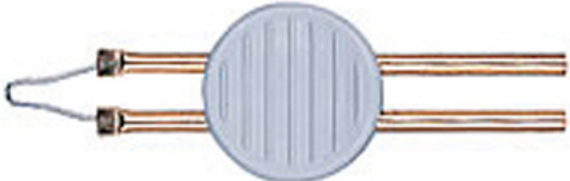
Item #	Description	Image
<p>Change-a-Tip Cautery</p> <p>These replaceable battery and replaceable tip cauteries are the next advance in battery-operated cauteries where reusability is a must. These products are excellent for the office, ER, and clinical procedures.</p>		
AXII640	<p>High-Temp Handle Replacement</p> <p>Bovie high-temperature handle that includes one fine-tip non-sterile tip and one "AA" alkaline battery. Sold 1 per box.</p>	
AXII943	<p>High-Temp Tip Replacement</p> <p>Bovie high-temperature non-sterile fine-tip cautery tip. Replacement for Change-a-Tip handles. Sold 10 per box.</p>	
AXI3426	<p>Low-Temp Tip Replacement</p> <p>Bovie low-temperature non-sterile fine-tip cautery tip. Replacement for Change-a-Tip handles. Sold 10 per box.</p>	
AXI4343	<p>Low-Temp Handle Replacement</p> <p>Bovie low-temperature handle that includes one fine-tip non-sterile tip and one "AA" alkaline battery. Sold 1 per box.</p>	
AXI5372	<p>High-Temp Tip Replacement</p> <p>Bovie high-temperature non-sterile loop-tip cautery tip. Replacement for Change-a-Tip handles. Sold 10 per box.</p>	

CAUTERIES

Item #	Description	Image
--------	-------------	-------

High-Temperature Cautery

High-temperature cauteries are popular for many types of procedures, including pinpoint hemostasis, evacuation of a subungual hematoma, controlling diffuse bleeders, and sculpting woven grafts. Cauteries are individually packaged, sterile, and sold 10 per box.

AXI0170 **Fine-Tip Cautery**
 Bovie high-temperature (2,200°F) fine-tip cautery. Protective cover cap is included for storage and safe disposal.



AXI0319 **Loop-Tip Cautery**
 Medi-Pak high-temperature (2,200°F) loop-tip cautery.



AXI4250 **Microfine-Tip Cautery**
 Bovie high-temperature (2,000°F) microfine-tip cautery. Protective cover cap is included for storage and safe disposal.



Low-Temperature Cautery

With a variety of low temperatures and fine tips the surgeon is ensured precise pinpoint hemostasis. These cauteries can be used in a variety of ophthalmic procedures. Cauteries are individually packaged, sterile, and sold 10 per box.

AXI0339 **Fine-Tip Cautery**
 Bovie low-temperature (1,300°F) fine-tip cautery. Protective cover cap is included for storage and safe disposal.



AXI1971 **Microfine-Tip Cautery**
 Bovie low-temperature (850°F) microfine-tip cautery. Protective cover cap is included for storage and safe disposal.



AXI5167 **Fine-Tip Cautery**
 Accu-Temp low-temperature (1200°F) fine-tip cautery.



CAUTERIES

Item #	Description	Image
--------	-------------	-------

Eye Bubble

The Bovie eye bubble is a clear protective bubble that is to be used for ophthalmic procedures. Sold 10 per box.

AXI5014	Eye Bubble	
---------	----------------------------	--



SCALPELS & BLADES

Item #	Description	Image
--------	-------------	-------

BD Bard-Parker Scalpel Blade

Offers the superior cutting advantages of carbon steel technology, including consistent sharpness, control, and strength. Packaged for safety and ease of use. Sterile. Sold 50 per box.

AXI5390	#10 Blade Size 10 scalpel blade.	
---------	---	--



AXI0919	#11 Blade Size 11 scalpel blade. Carbon steel rib-back.	
---------	--	--



AXI3981	#11 Blade Size 11 scalpel blade. Stainless steel.	
---------	--	--



AXI0126	#15 Blade Size 15 scalpel blade. Carbon steel rib-back.	
---------	--	--

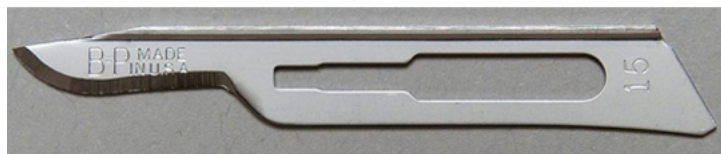

SCALPELS & BLADES

Item #	Description	Image
--------	-------------	-------

Beaver Mini-Blade

Beaver's Mini-Blades are manufactured using a proprietary grindless technology that yields consistent sharpness and blade geometry and are available in a variety of designs to meet all small incision and excision needs. Beaver Mini-Blades are preassembled into a unique, patented tip, designed for safe assembly and ease of use. Each mini-blade is color coded for easy identification and has a screw handle. Sterile. Sold 20 per box.

AXI3843	<p>#64 Blade</p> <p>Size 64 blade that is grindless, rounded tip, and sharp on one side. Green.</p>
---------	--



AXI5329	<p>#69 Blade</p> <p>Size 69 blade that is grindless, straight, sharp all around, 180-degree cutting surface, and double bevel blade. Blue.</p>
---------	---



Change-a-Blade Safety Scalpel Handle

This size 3 handle allows the surgeon to use the preferred choice of blade while eliminating hazard with a protective safety shield. Requires no change in surgeon's technique. Blade can be changed as often as needed throughout procedure. Same width, puncture-ability and visibility as a traditional scalpel handle. Sterile. Sold 48 per case.

AXI5435	<p>Change-a-Blade</p>
---------	------------------------------

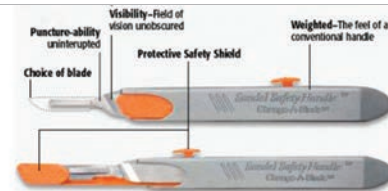

Cincinnati Lance Blade

Size 11 lance blade comes sterile. Lance sterile surgical blades enjoy the reputation for consistently longer lasting, unequaled cutting edges. All blades are individually wrapped in a peel-open package. Sterile. Sold 100 per box.

AXI0905	<p>Cincinnati Lance Blade</p>
---------	--------------------------------------



SCALPELS & BLADES

Item #	Description	Image
--------	-------------	-------

Cincinnati Surgical Blade Remover		
--	--	--

The C/S blade remover assists in the safe removal of blades, thereby greatly reducing the risk of injury and infection. When ready to discard, the unit and its contents may be safely autoclaved and disposed of in a proper manner. Sold 10 per box.

AXI4249	Blade Removal System	
---------	-----------------------------	--



Cincinnati Surgical Blade		
----------------------------------	--	--

Cincinnati Surgical blades have an unmatched reputation for quality. Both the stainless and carbon blades are manufactured of high grade British surgical steel, resulting in exceptional durability and sharpness. Individually wrapped in an easy-to-use peel-open package. Sterile. Sold 100 per box.

AXI5052	Surgical Blade #12 Size I2 surgical blade.	
---------	--	--



AXI3360	Surgical Blade #10 Size I0 surgical blade.	
---------	--	--









AX9810	Surgical Blade #11 Size I1 surgical blade.	
--------	--	--





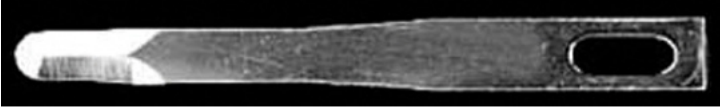

AX9811	Surgical Blade #15 Size I5 surgical blade.	
--------	--	--



SCALPELS & BLADES

Item #	Description	Image
Miltex General-Purpose Blade		
Stainless steel general-purpose blades are disposable and provide a smooth, sharp edge for a precise incision. Sterile. Sold 100 per box.		
AXI4189	Blade #11 Size 11 blade.	
AXI5555	Blade #15 Size 15 blade.	
Miniature Surgical Blade		
Sharp miniature blades that are made from high-quality surgical stainless steel and are designed for precise incisions. Sterile.		
AXI0439	Cincinnati Blade #64 Size 64 miniature blade. Sold 25 per box. Manufactured by Cincinnati Surgical.	
AXI0438	Cincinnati Blade #65 Size 65 miniature blade. Sold 25 per box. Manufactured by Cincinnati Surgical.	
AXI3195	Cincinnati Blade #67 Size 67 miniature blade. Sold 25 per box. Manufactured by Cincinnati Surgical.	
AXI1011	Cincinnati Blade #69 Size 69 miniature blade. Sold 25 per box. Manufactured by Cincinnati Surgical.	
AXI3055	Surgistar Blade 15-degree pointed lance blade. Sold 12 per box. Manufactured by Surgistar.	

SCALPELS & BLADES

Item #	Description	Image
AXI4137	<p>Surgistar Blade</p> <p>Miniature blade with a round tip, sharp all around, and straight. Sold 6 per box. Manufactured by Surgistar.</p>	
AXI5106	<p>Surgistar Blade</p> <p>Miniature blade with a curved tip and sharp on one side. Sold 12 per box. Manufactured by Surgistar.</p>	
AXI5325	<p>Surgistar Blade</p> <p>Miniature blade with a round tip and sharp on one side. Sold 12 per box. Manufactured by Surgistar.</p>	
AXI5324	<p>Surgistar Blade</p> <p>Miniature blade with a 1.5mm chisel tip. Sold 12 per box. Manufactured by Surgistar.</p>	



Size 10 Disposable Scalpel

Size 10 sterile scalpels incorporate superior stainless steel blades on uniquely designed handles. Each scalpel is supplied with a flexible blade cover for complete user protection. Sterile. Sold 10 per box.

AXI1213	<p>Scalpel #10</p>	
---------	---------------------------	--

Size 11 Disposable Scalpel

Size 11 sterile scalpels incorporate superior stainless steel blades on uniquely designed handles. Sterile. Sold 10 per box.

AXI0055	<p>Cincinnati Scalpel</p> <p>Size 11 scalpel. Cincinnati Surgical scalpels incorporate superior stainless steel blade on a uniquely designed handle. Each scalpel is supplied with a flexible blade cover for complete user protection.</p>	
AXI4179	<p>Miltex Scalpel</p> <p>Size 11 scalpel. Manufactured by Miltex.</p>	

SCALPELS & BLADES

Item #	Description	Image
AXI4191	<p>Bard-Parker Scalpel</p> <p>Size II scalpel. Manufactured by Aspen Surgical Products.</p>	

Size II Safety Disposable Scalpel

Size II safety scalpels are designed to minimize the risk of surgical blade injuries with a retractable shield or retractable blade. Allows clinicians to easily and safely operate with one hand. Sterile. Sold 10 per box.

AXI5249	<p>Moore Scalpel</p> <p>Size II scalpel with a protective sheath that covers the blade, safeguarding against accidental cuts when removing the scalpel from the package, while passing the scalpel, and during disposal. Manufactured by Moore Medical.</p>	
---------	--	--

AXI3986	<p>Miltex Blade</p> <p>Size II safety retractable blade. Manufactured by Miltex.</p>	
---------	---	--

AXI5160	<p>Aspen Blade</p> <p>Size II safety scalpel with retractable, locking shield. Manufactured by Aspen Surgical Products.</p>	
---------	--	--

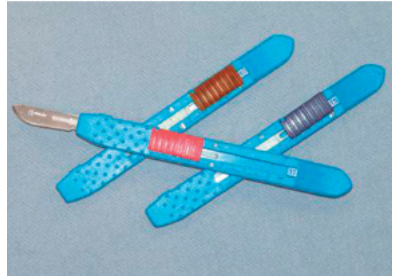
AXI4280	<p>McKesson Blade</p> <p>Medi-Pak Performance safety scalpel with retractable blade that has three positions: USE, PASS, and DISPOSE, with steadfast disposal lock. Locks into USE position. Disposal lock status indicator. Manufactured by McKesson.</p>	
---------	---	--

Size 15 Disposable Scalpel

Size 15 sterile scalpels that incorporate superior stainless steel blades on uniquely designed handles. Sterile. Sold 10 per box.

AXI0095	<p>Cincinnati Scalpel</p> <p>Size 15 scalpel. Superior stainless steel blade on a uniquely designed handle. Each scalpel is supplied with a flexible blade cover for complete user protection. Manufactured by Cincinnati Surgical.</p>	
---------	--	--

SCALPELS & BLADES

Item #	Description	Image
AXI1941	Miltex Scalpel Size 15 scalpel. Manufactured by Miltex.	
AXI4348	BD Scalpel Size 15 scalpel. Manufactured by Aspen Surgical Products.	

Size 15 Safety Disposable Scalpel

Size 15 safety scalpel designed to minimize the risk of surgical blade injuries with a retractable shield or retractable blade. Allows clinicians to easily and safely operate with one hand. Sterile. Sold 10 per box.

AXI1940	Miltex Scalpel Size 15 safety scalpel with retractable blade. Manufactured by Miltex.	
AXI5161	BD Scalpel Size 15 safety scalpel with retractable, locking shield. Manufactured by Aspen Surgical Products.	

AXI5190	McKesson Scalpel Medi-Pak Performance safety scalpel with retractable blade that has three positions: USE, PASS, and DISPOSE, with steadfast disposal lock. Locks into USE position. Disposal lock status indicator. Manufactured by McKesson.
---------	--

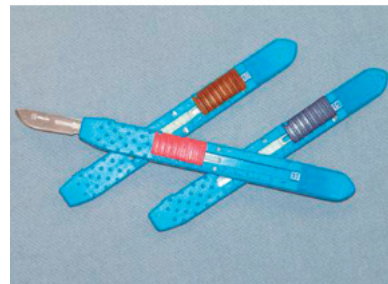



Size 21 Disposable Scalpel

Size 21 scalpel that comes sterile. Cincinnati Surgical scalpels incorporate superior stainless steel blade on a uniquely designed handle. Each scalpel is supplied with a flexible blade cover for complete user protection. Sold 10 per box.

AXI1240	Handle and Blade #21	
---------	-----------------------------	--

SCALPELS & BLADES

Item #	Description	Image
Surgistar Handle and Blade		
Various types of blades that slide into handles as well as full handle and blade sets. Manufactured by Surgistar. Sterile. Sold 6 per box.		
AXI3207	Blade #57 Scleral blade only that slides into a handle, #57. Standard US style.	
AXI4262	Blade #66 Lamellar blade only that slides into a handle, #66. Angled tip, bevel up.	
AXI4425	Handle and Blade #57 Scleral blade and handle set, #57. Standard US style.	

DRAPES

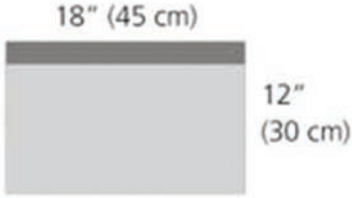
Item #	Description	Image
Adhesive Towel Drape		
These towel drapes feature an aggressive adhesive that leaves no residue, a non-linting, tear-resistant poly release liner, and a strong, drapable, low-glare matte finish film. Sterile. Sold 10 per box.		
AXI0146	Surgical Towel, Short This towel drape measures 18" x 12" and the adhesive area measures 18" x 1.5".	 <p>18" (45 cm)</p> <p>12" (30 cm)</p> <p>KEY: Adhesive Matte Film</p>

DRAPES

Item #	Description	Image
AXI0508	<p>Surgical Towel, Long</p> <p>Large towel drape measures 18" x 24" and the adhesive area measures 18" x 2".</p>	

Aperture Drape

Circular aperture with adhesive area. Non-linting, tear-resistant, waxy paper release liner. Thin, soft, drapeable, low-glare matte-finish film. Sterile.

AXI3164	<p>Aperture Drape</p> <p>Aperture drape measuring 16" x 16" with 2.5" circular aperture and 5" x 5" adhesive area. Sold 10 per box.</p>	
---------	--	--

AXI0591	<p>Minor Procedure Drape</p> <p>2.5" circular aperture with an adhesive area that measures 4.5" x 5". Drape measures 24" x 26". Great for minor procedures. Sold 25 per box.</p>	
---------	---	--

DRAPES

Item #	Description	Image
--------	-------------	-------

Aperture Pouch Drape

Drape measures 19" x 15" with an oval aperture that measures 2.4" x 1.4". Adhesive around aperture measures 5" x 4" and adhesive tabs measure 2" x 2". Oval aperture with adhesive optimized for skin. Non-linting, tear-resistant, waxy paper release liner. Two adhesive tabs for additional support. Moldable strip for additional fluid control. Soft, drapeable, low-glare matte-finish film. Sterile. Sold 10 per box.

AXII696	Aperture Pouch Drape	
---------	--------------------------------------	--

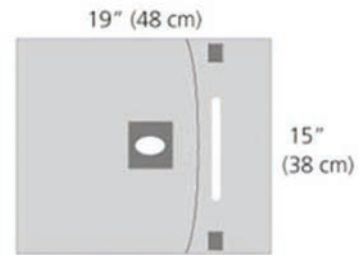

KEY: Adhesive Matte Film

Convertors Mayo Stand Cover

Sterile, single-use, reinforced poly mayo stand cover. Measures 22.75" x 55.5". Sold 30 per box.

AXII750	Mayo Stand Cover	
---------	----------------------------------	--

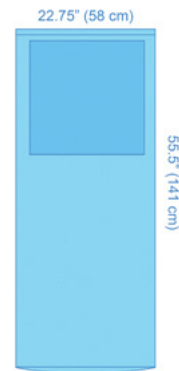

Convertors Refractive Drape

Sterile, 2-piece drape with circle aperture. Adhesive square around aperture area. For use in LASIK, refractive, corneal, and lid/plastic procedures. Overall size is 16" x 10.75". Aperture measures 1.5" x 0.98" and adhesive area is 3" x 3". Sold 10 per box.

AXIO432	Convertors Refractive Drape	
---------	---	--

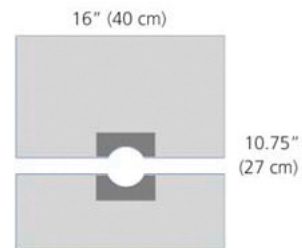

KEY: Adhesive Matte Film

DRAPES

Item #	Description	Image
--------	-------------	-------

Drape Cover

Clear, sterile poly cover used to cover table, as a barrier sheet or set up cover. Measures 44" x 72". Sold 25 per box.

AXI1033 **Drape Cover**

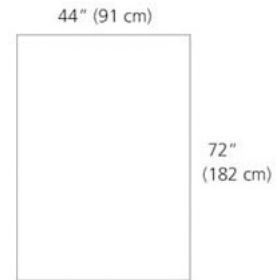

KEY: Clear Film

General-Purpose Drape

General-purpose drapes. Unfenestrated and without pouches.

AXI3674 **Physical Exam Drape**

Nonsterile, general-purpose physical exam drape measuring 40" x 48". 2-ply, white, pebble-embossed, tissue drape. Sold 100 per box.







AXI4908 **Half Drape**

Sterile convertors, general-purpose half drape measuring 44" x 57". Sold 20 per box.

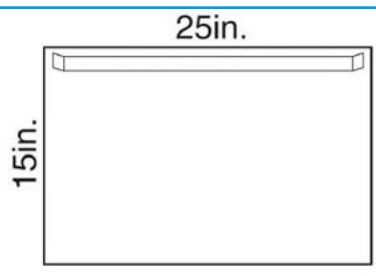

DRAPES

Item #	Description	Image
AXI1929	<p>Utility Drape</p> <p>A 2-pack of sterile utility drapes measuring 25" x 15" with adhesive tape. Sold 2 drapes per pack and 100 packs per box.</p>	 <p>A technical diagram of a rectangular utility drape. The top edge is labeled '25in.' and the left edge is labeled '15in.'. The drape is shown with a folded top edge, indicating an adhesive strip.</p>
AXI3185	<p>Towel Drape</p> <p>Sterile, general-purpose Best Value towel drape measuring 15" x 26" with adhesive strip. Sold 2 per pack.</p>	 <p>A photograph showing several folded towel drapes. There are two blue drapes and two white drapes, all with visible adhesive strips on their top edges.</p>
AXI4105	<p>Three-Quarter Drape</p> <p>Sterile general-purpose Convertors Tiburon three-quarter drape. Measures 57" x 76" and is made with Tiburon fabric. Sold 20 per box.</p>	 <p>A photograph showing several white three-quarter drapes. Some are folded into neat stacks, while others are partially unfolded, showing their large size and the adhesive strip at the top.</p>
AXI1506	<p>X-Large Drape</p> <p>Extra-large general-purpose drape measuring 77" x 98". Sterile. Sold 12 per box.</p>	 <p>A photograph of a single, large, light-colored drape folded into a neat stack. The fabric appears to have a fine, woven texture.</p>

DRAPES

Item #	Description	Image
--------	-------------	-------

AXI2042 **Half Drape**
Sterile, general-purpose half drape measuring 60" x 44". Sold 54 per box.

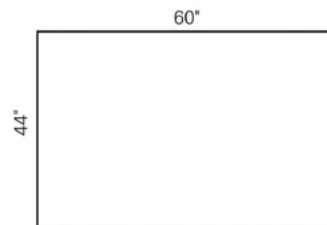

AXI3441 **Half Drape**
Sterile half surgical drape measures 40" x 58". Top-of-the-line SMS fabric, composed of five strong fiber layers for exceptionally high barrier strength. Made of 100% polypropylene, SMS drapes are soft and drapeable. Composed with the latest generation SMS technology, drapes have smaller fibers and a more uniform fiber lay-down. Sold 20 per box.



Incise Drape

Sterile incise drape. Thin, conformable, low-glare matte finish film. Aggressive adhesive with no residue. Sold 10 per box.

AXO951 **Mini Incise Drape**
EENT mini incise drape with adhesive center. Drape measures 6.5" x 7.5" with an adhesive area measuring 4" x 7.5".

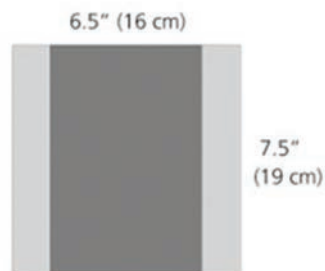

KEY: Adhesive Matte Film

AXII886 **Medium Incise Drape**
Incise drape measures 16" x 16" with an adhesive area measuring 5" x 5".

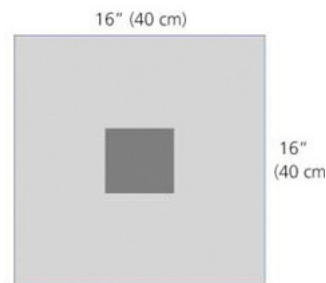

KEY: Adhesive Matte Film

DRAPES

Item #	Description	Image
--------	-------------	-------

AXI0560 **Large Incise Drape**
 Incise drape measures 36" x 33" with an adhesive area measuring 23.5" x 33".

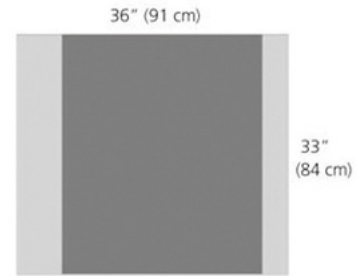

KEY: Adhesive Matte Film

AXI3424 **X-Large Incise Drape**
 Incise drape measures 48" x 51" with an adhesive area measuring 5" x 4.5".

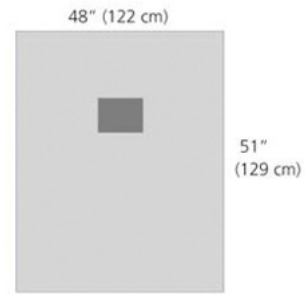

KEY: Adhesive Matte Film

Incise Drape with Pouch

Drape measures 48" x 51". Adhesive area measures 5" x 4.5" and pouch measures 10" x 11". Incise adhesive area. Non-linting, tear-resistant, waxy paper release liner. Fluid pouch with moldable strip for additional fluid control. Soft, drapeable, low-glare matte-finish film. Sterile. Sold 10 per box.

AXI0830 **Incise Drape with Pouch**

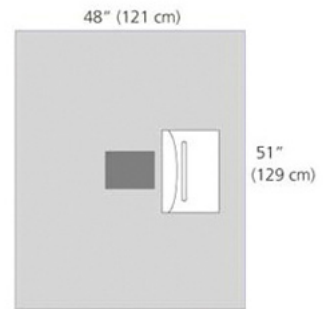

KEY: Adhesive Matte Film Clear Film

DRAPES

Item #	Description	Image
--------	-------------	-------

Instrument Cover

Large instrument cover measures 24" x 18". Used to cover instruments or mayo stand. This drape features a strong, clear, poly film that is transparent for improved observation and provides a barrier to fluids. It also features an aggressive adhesive strip with no residue. Sterile. Sold 10 per box.

AXI0525	Instrument Cover	
---------	-------------------------	--



Medi-Pak Performance Drape

Minor procedure Medi-Pack performance sterile field drape measures 18" x 26". Made out of tissue and poly. Unfenestrated. Sterile. Sold 50 per box.

AXI4994	Medi-Pak Performance Drape	
---------	-----------------------------------	--



Poly U Drape

Drape measures 48" x 52". Adhesive area measures 10" x 19" and "U" fenestration measures 6" x 19". "U" fenestration with wide adhesive area. Advanced adhesive provides excellent adhesion with no residue. Strong, drapeable, low-glare matte-finish film. Split, waxy paper liner for ease of application. Sterile. Sold 10 per box.

AXII032	Poly U Drape	
---------	---------------------	--

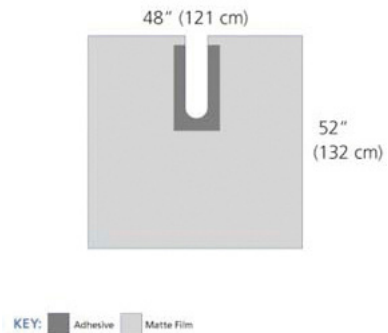

DRAPES

Item #	Description	Image
--------	-------------	-------

Split Sheet Drape

Sterile Convertors Tiburon split sheet drape measures 77" x 108". With absorbent Iso Bac reinforcement measuring 28" x 38" and split adhesive. Surgical area measures 37" x 2.5". Sold 10 per box.

AXI4460	Split Sheet Drape	
---------	--------------------------	---

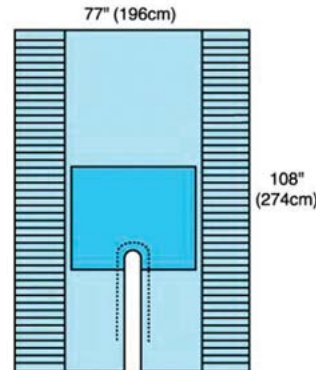

Towel Drape

Disposable, sterile towel drapes for use in minor surgical or therapeutic procedures where a sterile field or drape is required. Poly-interlined, 3-ply construction – tissue/poly/tissue – provides absorbency while preventing possible moisture or bacteria migration. Sold 50 per box.

AXII347	Non-Fenestrated Drape	Drape measures 18" x 26" and is non-fenestrated.	
---------	------------------------------	--	---



AXII419	Fenestrated Drape	Drape measures 18" x 26". Has 2.75" fenestrated opening.	
---------	--------------------------	--	---



EYE SHIELDS

Item #	Description	Image
--------	-------------	-------

Blue Eye Shield

Blue non-sterile polycarbonate pinhole shield, universal size with deep shell. Does not have guarder or padded lining. Sold 50 per box.

AXI0494	Non-Sterile Blue Eye Shield	
---------	------------------------------------	--





Clear Eye Shield

Clear polycarbonate and plastic shields that allow for maximum comfort and protection for post-operative patients. Shields come sterile or non-sterile and are vented to reduce fogging. Adult and youth universal sizing with deep and standard shells.

AXI0445	Non-Sterile Clear Eye Shield	
---------	-------------------------------------	---

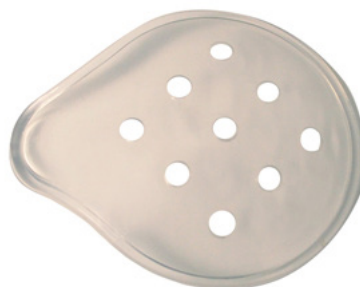
Clear non-sterile polycarbonate vented shield, universal size with deep shell. Does not have guarder or padded lining. Sold 50 per box.



AXI2010	Non-Sterile Clear Eye Shield	
---------	-------------------------------------	--

Clear non-sterile polycarbonate vented shield, universal size with deep shell. Does not have guarder or padded lining. Sold 100 per box.

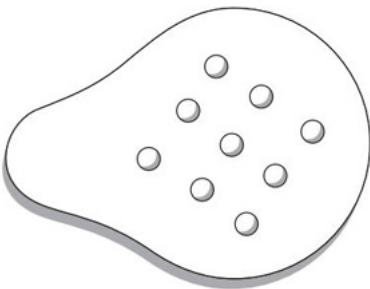
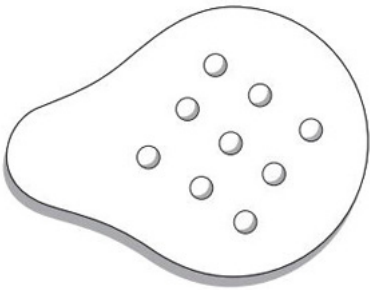
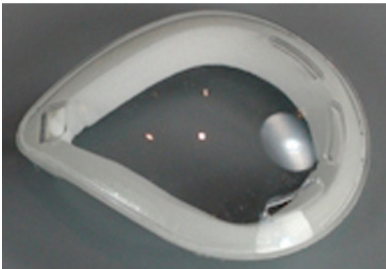
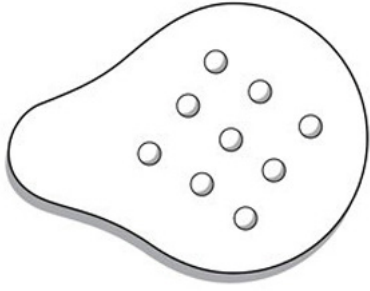

EYE SHIELDS

Item #	Description	Image
AXI4116	<p>Sterile Clear Eye Shield</p> <p>Clear sterile plastic vented shield, universal size with standard shell. Does not have guarder or padded lining. Sold 50 per box.</p>	
AXI5042	<p>Non-Sterile Clear Eye Shield</p> <p>Clear non-sterile plastic vented shield, universal size with standard shell. Does not have guarder or padded lining. Sold 100 per bag.</p>	
AXI5346	<p>Non-Sterile Clear Eye Shield</p> <p>Clear non-sterile polycarbonate vented shield, universal youth size with standard shell. Shield has foam lining but no guarder. Sold 25 per box.</p>	
AXI5723	<p>Sterile Clear Eye Shield</p> <p>Clear sterile plastic vented shield, universal 3" x 2.5" size with standard shell. Does not have guarder or padded lining. Sold 50 per box.</p>	

EYE SHIELDS

Item #	Description	Image
--------	-------------	-------

Gray Eye Shield

Gray tinted non-sterile polycarbonate vented shield, universal size with deep shell. Does not have guarder or padded lining. Sold 50 per box.

AXI5590	Non-Sterile Gray Eye Shield	
---------	---	--



Metal Eye Shield

Aluminum non-sterile pinhole shield, universal size with standard shell. Shield has a white thermoplastic guarded edge that is latex-free. No padded lining. Sold 50 per box.

AXI0193	Non-Sterile Metal Eye Shield	
---------	--	--



IRIS RETRACTORS

Item #	Description	Image
--------	-------------	-------

Disposable Iris Retractor

Sterile, disposable iris retractors. Used to gently stretch and stabilize the iris for increased visibility during surgery. The iris retractor is held in place by an adjustable silicone circle. Sold in set of 5.

AXI4020	Iris Retractor, Polypropylene Polypropylene iris retractor.	
---------	--	--



IRIS RETRACTORS

Item #	Description	Image
AXI4139	Iris Retractor, Nylon Nylon iris retractor.	

Reusable Iris Retractor

Reusable, polypropylene iris retractors with autoclavable case. Used to gently stretch and stabilize the iris for increased visibility during surgery. The iris retractor is held in place by an adjustable silicone circle. Sold 6 per set and come in reusable autoclavable case.

AXI5156	Iris Retractors with Case	
---------	----------------------------------	--

LIQUID BANDAGES

Item #	Description	Image
Histoacryl Topical Skin Adhesive		
Histoacryl has been referenced in more than 1,200 publications world-wide and is one of the most used topical skin adhesives. This skin adhesive forms a strong bond that seals the wound quickly and inhibits the growth of bacteria. Aesculap Histoacryl Blue Topical Skin Adhesive liquid comes in a 0.5ml tube with a precision applicator tip that provides a precise controlled application. The active ingredient is n-butyl-2 cyanoacrylate.		

AXI4287	0.5ml Skin Adhesive	
---------	----------------------------	--

PVA PRODUCTS/WECK-CEL

Item #	Description	Image
--------	-------------	-------

Corneal Light Shield

Used to protect hinge and posterior side of corneal flap. Used to protect the retina from the operating microscope light. Sold 20 per box.

AXI0089	<p>Ultracell Corneal Light Shield</p> <p>Corneal light shield, 7mm (0.28"). Made from PVA material. Manufactured by Beaver-Visitec.</p>
AXII998	<p>Merocel Corneal Light Shield</p> <p>Corneal light shield, 8mm (0.3") diameter. Made from exclusive Merocel PVA material. The Merocel material is lint-free. Designed to provide the surgeon with a superior fiber-free product. Manufactured by Beaver-Visitec.</p>
AXI5553	<p>Corneal Light Shield</p> <p>Coreneal light sheild, 8mm diameter (0.3"). Lint-free PVA material that keeps cornea moist. Manufactured by Hurricane Medical.</p>



Cellulose Eye Spear

Made from highly absorbent, natural, cellulose material. Fast wicking action delivers quick absorption of blood and fluid from the surgical area. The flat tip provides precise application at the surgical incision. Light blue handle.

AXI0087	<p>Ultraspear Eye Spear</p> <p>100 count, 5 per pouch, 20 pouches per box.</p>
AXI0088	<p>Ultraspear Eye Spear</p> <p>200 count, 10 per pouch, 20 pouches per box.</p>



PVA Eye Spear

Various brand PVA eye spears made from highly absorbent Merocel polyvinyl acetal (PVA) material. Designed to benefit both the patient and surgeon, each device is absorbent and firm, allowing gentle manipulation of delicate tissues during LASIK and other corneal procedures. Triangle-shaped spearhead, set on a malleable, polypropylene handle. Latex-free.

AXI0085	<p>Accutome Eye Spear</p> <p>Blue handle. 100 count, 5 per pouch, 20 pouches per box.</p>
AXI0086	<p>Accutome Eye Spear</p> <p>Blue handle. 200 count, 10 per pouch, 20 pouches per box.</p>
AXI5430	<p>Keracel Eye Spear</p> <p>Red handle. 60 count, 3 per pouch, 20 pouches per box.</p>
AXI5429	<p>Merocel Eye Spear</p> <p>Blue handle. 50 count, 5 per pouch, 10 pouches per box.</p>
AXI5643	<p>Ultraspear Eye Spear</p> <p>Light blue handle. 100 count, 5 per pouch, 20 pouches per box.</p>
AXI5644	<p>Ultraspear Eye Spear</p> <p>Light blue handle. 200 count, 10 per pouch, 20 pouches per box.</p>



PVA PRODUCTS/WECK-CEL

Item #	Description	Image
--------	-------------	-------

LASIK PVA Disk

Round surgical PVA sponge disks for LASIK surgery. Various size disks on plastic handles. One sterile round per pack. Sold 20 packs per box.

AXI0516 **9mm LASIK Disk**
Surgical rounds that measure 9mm in diameter.

AXI5118 **7mm LASIK Disk**
Surgical rounds that measure 7mm in diameter.



Ultracell Instrument Wipe

This Ultracell PVA instrument wipe is used in the care and cleaning of surgical instruments. 2mm thick instrument wipe that measures 3 x 3 inches. Sold 20 per box.

AXI0092 **Instrument Wipe**



SURGICAL GLOVES

Item #	Description	Image
--------	-------------	-------

Derma Prene Ultra Surgical Gloves

The Ansell Derma Prene Ultra surgical glove is powder-free and made from latex-free neoprene. It is a good choice for latex-sensitive (Type I) and chemical-sensitive (Type IV) health-care professionals and patients. The Derma Prene Ultra is dark green in color for instant identification as a natural rubber latex-free glove. The glove is typically 12 inches in length and has an enhanced, beaded cuff and SureFit Technology for extra coverage and protection on the forearm, and to maintain the glove's position on surgical gowns. Hand-specific, sterile, powder-free smooth surface. Straight cuffs, intended for single use. 11.9" long with 0.19mm fingertip thickness. Sold 50 pairs per box.

AXI1265	Derma Prene Gloves, Size 7 Size 7 Derma Prene Ultra neoprene surgical gloves.	
---------	---	--

AXI1774	Derma Prene Gloves, Size 7.5 Size 7.5 Derma Prene Ultra neoprene surgical gloves.
---------	---

**Encore Acclaim Surgical Gloves**

The Encore Acclaim is Ansell's premier powder-free surgical glove made from natural rubber latex. The glove's thickness allows for a comfortable fit and excellent tactile sensitivity during surgical procedures in a single- or double-gloving environment. Its smooth finish provides worry-free instrument and suture control, and its low allergen levels help reduce the risk of latex sensitization in health-care workers and patients. Hand-specific, sterile, powder-free ivory gloves with smooth surface. Beaded cuffs, intended for single use, 11.5" long with 0.25mm fingertip thickness. Sold 50 pairs per box.

AXI0235	Encore Gloves, Size 6.5 Size 6.5 Encore Acclaim latex surgical gloves.	
---------	--	--

AXI1798	Encore Gloves, Size 7 Size 7 Encore Acclaim latex surgical gloves.
---------	--

AXI1799	Encore Gloves, Size 7.5 Size 7.5 Encore Acclaim latex surgical gloves.
---------	--

AXI3009	Encore Gloves, Size 8 Size 8 Encore Acclaim latex surgical gloves.
---------	--



SURGICAL GLOVES

Item #	Description	Image
--------	-------------	-------

Encore Surgical Gloves

Encore surgical gloves are powder-free and made from natural rubber latex. The gloves have a textured finish for superior grip and handling, and their low allergen levels help reduce the risk of latex sensitization in health-care workers and patients. Hand-specific, sterile, powder-free, ivory gloves with a fully textured surface. Each glove has beaded cuffs and is intended for single use. Size 6.5, 11.5" in length with a 0.23mm fingertip thickness. Manufactured by Ansell. Sold 50 pairs per box.

AX11369	Encore Gloves, Size 6.5	
---------	---	--

**No Powder Surgical Gloves**

These latex gloves have a straight, reinforced cuff for extra coverage and protection on the forearm and a textured finish for superior grip and handling of instruments and sutures. Powder-free to help eliminate powder-related post-operative complications and sensitivity. Hand-specific, sterile, powder-free, ivory gloves with a fully textured surface. Each glove has straight cuffs and is intended for single use. 11.8" in length with a 0.23mm fingertip thickness. Manufactured by Ansell. Sold 50 pairs per box.

AX10981	No Powder Gloves, Size 6.5	
---------	--	--

	Size 6.5 surgical gloves.	
--	---------------------------	--

AX10943	No Powder Gloves, Size 7	
---------	--	--

	Size 7 surgical gloves.	
--	-------------------------	--

AX10918	No Powder Gloves, Size 7.5	
---------	--	--

	Size 7.5 surgical gloves.	
--	---------------------------	--

AX10982	No Powder Gloves, Size 8	
---------	--	--

	Size 8 surgical gloves.	
--	-------------------------	--

**Perry Performance Plus Micro-Thin Surgical Gloves**

Perry Performance Plus micro-thin latex surgical gloves. Hand-specific, sterile, powder-free, polymer coating, brown gloves with a textured surface. Each glove has straight cuffs and is intended for single use. 11.4" in length with a 0.19mm fingertip thickness. Manufactured by Mckesson. Sold 40 pairs per box.

AX11683	Surgical Gloves, Size 7	
---------	---	--

	Size 7 micro-thin surgical gloves.	
--	------------------------------------	--

AX11881	Surgical Gloves, Size 8	
---------	---	--

	Size 8 micro-thin surgical gloves.	
--	------------------------------------	--



SURGICAL GLOVES

Item #	Description	Image
--------	-------------	-------

Perry Performance Plus Surgical Gloves

Perry Performance Plus latex and neoprene surgical gloves. Various glove sizes that are hand-specific and intended for single use. Sterile. Manufactured by Mckesson. Sold 40 pairs per box.

AXI4092

Surgical Gloves, Size 5.5

Size 5.5 Perry Performance Plus latex surgical gloves. Powder-free, cream-colored gloves with a smooth surface. Each glove has beaded cuffs and is intended for single use. 11.5" in length with a 0.23mm fingertip thickness.



AXII830

Surgical Gloves, Size 6

Size 6 Perry Performance Plus latex surgical gloves. Powder-free, brown-colored gloves with a textured surface. Each glove has straight cuffs and is intended for single use. 11.4" in length with a 0.19mm fingertip thickness.



AXI4968

Surgical Gloves, Size 6

Size 6 Perry Performance Plus neoprene surgical gloves. Powder-free, dark green-colored gloves with a smooth surface. Each glove has beaded cuffs and is intended for single use. 12.2" in length with a 0.20mm fingertip thickness.



AXII68I

Surgical Gloves, Size 6.5

Size 6.5 Perry Performance Plus latex surgical gloves. Powder-free, brown-colored gloves with a fully textured surface. Each glove has straight cuffs and is intended for single use. 11.4" in length with a 0.19mm fingertip thickness.



SURGICAL GLOVES

Item #	Description	Image
AXI1715	<p>Surgical Gloves, Size 6.5</p> <p>Size 6.5 Perry Performance Plus latex surgical gloves. Powdered, cream-colored gloves with a smooth surface. Each glove has beaded cuffs and is intended for single use. 11.5" in length with a 0.23mm fingertip thickness.</p>	
AXI4964	<p>Surgical Gloves, Size 6.5</p> <p>Size 6.5 Perry Performance Plus neoprene surgical gloves. Powder-free, dark green-colored gloves with a smooth surface. Each glove has beaded cuffs and is intended for single use. 12.2" in length with a 0.20mm fingertip thickness.</p>	
AXI1684	<p>Surgical Gloves, Size 7</p> <p>Size 7 Perry Performance Plus latex surgical gloves. Powdered, cream-colored gloves with a smooth surface. Each glove has beaded cuffs and is intended for single use. 11.3" in length with a 0.23mm fingertip thickness.</p>	
AXI1688	<p>Surgical Gloves, Size 7</p> <p>Size 7 Perry Performance Plus latex surgical gloves. Powder-free, polymer coating, cream-colored gloves with a smooth surface. Each glove has beaded cuffs and is intended for single use. 11.5" in length with a 0.23mm fingertip thickness.</p>	

SURGICAL GLOVES

Item #	Description	Image
AXI4965	<p>Surgical Gloves, Size 7</p> <p>Size 7 Perry Performance Plus neoprene surgical gloves. Powder-free, dark green-colored gloves with a smooth surface. Each glove has beaded cuffs and is intended for single use. 12.2" in length with a 0.20mm fingertip thickness.</p>	
AXII432	<p>Surgical Gloves, Size 7.5</p> <p>Size 7.5 Perry Performance Plus latex surgical gloves. Powdered, cream-colored gloves with a smooth surface. Each glove has beaded cuffs and is intended for single use. 11.3" in length with a 0.23mm fingertip thickness.</p>	
AXII626	<p>Surgical Gloves, Size 7.5</p> <p>Size 7.5 Perry Performance Plus latex surgical gloves. Powder-free, brown-colored gloves with a textured surface. Each glove has straight cuffs and is intended for single use. 11.4" in length with a 0.19mm fingertip thickness.</p>	
AXII646	<p>Surgical Gloves, Size 7.5</p> <p>Size 7.5 Perry Performance Plus latex surgical gloves. Powder-free, polymer-coated, cream-colored gloves with a smooth surface. Each glove has beaded cuffs and is intended for single use. 11.5" in length with a 0.23mm fingertip thickness.</p>	

SURGICAL GLOVES

Item #	Description	Image
AXI5112	<p>Surgical Gloves, Size 7.5</p> <p>Size 7.5 Perry Performance Plus neoprene surgical gloves. Powder-free, dark green-colored gloves with a smooth surface. Each glove has beaded cuffs and is intended for single use. 12.2" in length with a 0.20mm fingertip thickness.</p>	
AXI0957	<p>Surgical Gloves, Size 8</p> <p>Size 8 Perry Performance Plus latex surgical gloves. Powdered, cream-colored gloves with a smooth surface. Each glove has beaded cuffs and is intended for single use. 11.3" in length with a 0.23mm fingertip thickness.</p>	
AXII649	<p>Surgical Gloves, Size 8</p> <p>Size 8 Perry Performance Plus latex surgical gloves. Powder-free, cream-colored gloves with a smooth surface. Each glove has beaded cuffs and is intended for single use. 11.5" in length with a 0.23mm fingertip thickness.</p>	
AXII627	<p>Surgical Gloves, Size 8.5</p> <p>Size 8.5 Perry Performance Plus latex surgical gloves. Powder-free, brown-colored gloves with a fully textured surface. Each glove has straight cuffs and is intended for single use. 11.4" in length with a 0.19mm fingertip thickness.</p>	

SURGICAL GLOVES

Item #	Description	Image
AX11737	<p>Surgical Gloves, Size 8.5</p> <p>Size 8.5 Perry Performance Plus latex surgical gloves. Powder-free, cream-colored gloves with a smooth surface. Each glove has beaded cuffs and is intended for single use. 11.5" in length with a 0.23mm fingertip thickness.</p>	

Sempermed Supreme Surgical Gloves

Sempermed Supreme surgical gloves are anatomically designed to reduce hand fatigue and increase comfort. They are powder-free to eliminate aerosolization and skin irritation. A special multi-layer copolymer composition provides optimal protection during surgery. Hand-specific, sterile, powder-free, ivory-colored gloves with a micro-textured surface. Each glove has beaded cuffs and is intended for single use. 10.6" in length with a 0.27mm fingertip thickness. Manufactured by Sempermed USA. Sold 50 pairs per box.

AX15021	<p>Sempermed Gloves, Size 7.5</p>	
---------	--	---

SensiCare Surgical Gloves

SensiCare revolutionized the medical glove industry as the first latex-free synthetic polyisoprene surgical glove on the market. Medline is the only surgical glove manufacturer that makes its own raw material polyisoprene, called Isolex, ensuring you a safe, quality product. SensiCare is coated with 100% pure aloe vera to help soothe and moisturize dry, irritated skin caused by frequent handwashing and glove-wearing. Hand-specific, sterile, powder-free, white-colored gloves with a smooth surface coated in aloe and polymer. Each glove has beaded cuffs and is intended for single use. 12" in length with a 25mm fingertip thickness. Sold 25 pairs per box.

AX15155	<p>SensiCare Gloves, Size 6</p>	
	<p>Size 6 surgical gloves.</p>	
AX14889	<p>SensiCare Gloves, Size 7</p>	
	<p>Size 7 surgical gloves.</p>	
AX12048	<p>SensiCare Gloves, Size 7.5</p>	
	<p>Size 7.5 surgical gloves.</p>	
AX10852	<p>SensiCare Gloves, Size 8</p>	
	<p>Size 8 surgical gloves.</p>	

SURGICAL GLOVES

Item #	Description	Image
--------	-------------	-------

Sensi-Touch Surgical Gloves

Ansell Sensi-Touch powdered surgical gloves with a straight, reinforced non-beaded cuff for extra coverage and protection on the forearm. The glove's latex formulation provides superior strength, and its design helps to reduce hand fatigue. Hand-specific, sterile, powdered, ivory-colored gloves with a smooth surface. Intended for single use. 12.9" in length with a 0.24mm fingertip thickness. Sold 50 pairs per box.

AXI1186	Sensi-Touch Gloves, Size 6.5	
---------	-------------------------------------	--

Size 6.5 surgical gloves.

AXI1315	Sensi-Touch Gloves, Size 7
---------	-----------------------------------

Size 7 surgical gloves.

AXI1316	Sensi-Touch Gloves, Size 7.5
---------	-------------------------------------

Size 7.5 surgical gloves.

AXI2024	Sensi-Touch Gloves, Size 8.5
---------	-------------------------------------

Size 8.5 surgical gloves.

Original Perry Style 42 Surgical Gloves

Ansell's Original Perry Style 42 powdered surgical gloves provide uncompromising quality and durability. Their satin-smooth finish provides maximum tactile sensitivity and is produced with advanced technology to lower powder and protein levels. This product contains natural rubber latex, which may cause allergic reactions. This latex glove contains 60 micrograms or less of total water-extractable protein per gram. Hand-specific, sterile, powdered, ivory-colored gloves with a smooth anti-slip surface. Each glove has beaded cuffs and is intended for single use. 11.7" in length with a 0.23mm fingertip thickness. Sold 50 pairs per box.

AXI0836	Perry Gloves, Size 7	
---------	-----------------------------	--

Size 7 surgical gloves.

AXI0870	Perry Gloves, Size 7.5
---------	-------------------------------

Size 7.5 surgical gloves.

AXI1069	Perry Gloves, Size 8
---------	-----------------------------

Size 8 surgical gloves.

SURGICAL GLOVES

Item #	Description	Image
--------	-------------	-------

Triflex Surgical Gloves

Triflex sterile surgical gloves have an anti-slip finish for a firm grip and mechanically locking cuffs that prevent rolldown. Extensive rinse cycles on the gloves reduces latex allergens and proteins. Hand-specific, sterile, powdered, ivory-colored gloves with a smooth surface. Each glove has beaded cuffs and is intended for single use. 12" in length with a 0.23mm fingertip thickness. Manufactured by Cardinal. Sold 40 pairs per box.

AXI1455	Triflex Gloves, Size 7.5 Size 7.5 surgical gloves.
AXI0683	Triflex Gloves, Size 8 Size 8 surgical gloves.



Triumph Green Surgical Gloves

AORN, the CDC, the American College of Surgeons, and the American Academy of Orthopedic Surgeons recommend double gloving during invasive procedures. Triumph Green latex powder-free surgical gloves are ideal when double gloving with Aloetouch Natural, Triumph, or Triumph LT. Made from low-protein natural rubber latex with synthetic polymer coating. Dark green-colored gloves with a smooth surface coated in aloe and polymer. Each glove has beaded cuffs and is intended for single use. 12" in length with a 8.5mm fingertip thickness. Manufactured by Medline. Sold 50 pairs per box.

AXI3975	Triumph Gloves, Size 7
---------	-------------------------------



Triumph LT Surgical Gloves

All of Medline's powder-free gloves have a proprietary inner polymer coating, which allows for easy donning and double gloving. The Triumph LT Sterile Latex Powder-Free Surgical Glove is a standard-thickness glove that can be used alone or as an outer glove when double gloving over Medline's Aloetouch Latex-Free Powder-Free Surgical Glove. The unique beaded cuff is reinforced to resist tearing. Sterile, white-colored gloves with a lightly textured surface coated with synthetic polymer donning agent. Each glove has beaded cuffs and is intended for single use. 12" in length with a 23mm fingertip thickness. Manufactured by Medline. Sold 50 pairs per box.

AXI0900	Triumph Gloves, Size 7
---------	-------------------------------



SURGICAL LENSES

Item #	Description	Image
--------	-------------	-------

Bi-Concave Disposable Lens

Volk's disposable lenses deliver high-resolution, direct-image retinal views in a convenient sterile, single-use design. They are packaged individually in an easy-to-use peel pack. Sold 10 per pack.

AXI5229	Bi-Concave Disposable Lens	
---------	--	--

Flat Disposable Lens

Volk's disposable lenses deliver high-resolution, direct-image retinal views in a convenient sterile, single-use design. They are packaged individually in an easy-to-use peel pack. Sold 10 per pack.

AXI4910	Flat Disposable Lens	
---------	--------------------------------------	---

Flat SSV Disposable Lens

Primarily used for routine direct image vitreoretinal surgery of the central retina. Lens is Direct Image Flat (ACS) with a field of view of 30 degrees and an image magnification of 0.92x. Nonsterile, autoclavable. Sold individually.

AXI5012	Flat SSV Disposable Lens	
---------	--	--

SURGICAL LENSES

Item #	Description	Image
--------	-------------	-------

Magnifying Disposable Lens

Volk's disposable lenses deliver high-resolution, direct-image retinal views in a convenient sterile, single-use design. They are packaged individually in an easy-to-use peel pack. Sold 10 per pack.

AXI5044	Magnifying Disposable Lens	
---------	--	--

**Wide Field Disposable Lens**

Volk's disposable lenses deliver high-resolution, direct-image retinal views in a convenient sterile, single-use design. They are packaged individually in an easy-to-use peel pack. Sold 10 per pack.

AXI5063	Wide Field	
---------	----------------------------	---

**30-Degree Prism Disposable Lens**

Volk's disposable lenses deliver high-resolution, direct-image retinal views in a convenient sterile, single-use design. They are packaged individually in an easy-to-use peel pack. Sold 10 per pack.

AXI5230	30-Degree Prism Disposable Lens	
---------	---	--



SURGICAL LENSES

Item #	Description	Image
--------	-------------	-------

30-Degree Prism SSV ACS Lens

Primarily used for off-axis direct image vitreoretinal surgery. Lens is direct-image, 30-degree Prism (ACS) with a field of view of 30 degrees offset, and an image magnification of 0.90x. Patented Chalam SSV design eliminates the need for sutures or rings. Nonsterile, autoclavable. Sold individually.

AXI5402	30-Degree Prism Lens	
---------	--------------------------------------	--



Instrument Covers



PROTECTORS & GUARDS

Item #	Description	Image
--------	-------------	-------

Comply Instrument Protector

3M Comply Instrument Protectors, protect sharp-pointed surgical instruments from damage and reduces possibility of pouch puncture during sterilization. It protects sharp surgical instruments from damage while holding them open for full sterilant contact. Dual indicators on the protector verify steam or EO processing. White instrument protector that measures 2 x 5 inches and is latex-free. Sold 100 per box.

AXI3932 [White Instrument Protector](#)



Osteotome Instrument Tip Guard

Designed to protect osteotome instrument edges from chipping during sterilization, storage, and handling. Covers can reduce monthly repair or replacement costs by meeting protection needs. Clear, non-vented osteotome instrument tip protector. Measures 6.4mm x 19mm. Nonsterile and latex-free. Sold 50 per bag.

AXI0806 [Clear Instrument Guard](#)







Round Instrument Tip Guard

Rounded tip guards designed to protect medical instruments from damage during sterilization, storage, and handling. Covers can reduce monthly repair or replacement costs by meeting protection needs. Blue-tinted, vented instrument tip protectors. Measures 38.1mm in length and fits 3mm to 4mm tips. Nonsterile and latex-free. Sold 70 per bag.





AXII288 [Blue Instrument Guard](#)



PROTECTORS & GUARDS



Item #	Description	Image
Standard Instrument Tip Guard		
Designed to protect medical instruments from damage during sterilization, storage, and handling. Covers can reduce monthly repair or replacement costs by meeting protection needs. Nonsterile and latex-free. Sold 100 per bag.		
AXI0807	<p data-bbox="261 449 475 470">Clear Instrument Guard</p> <p data-bbox="261 483 779 525">Clear, vented instrument tip protectors. Measures 2.8mm x 19mm.</p>	
AXI1208	<p data-bbox="261 829 475 850">Clear Instrument Guard</p> <p data-bbox="261 863 763 905">Clear, vented instrument tip protectors. Measures 5mm x 25mm.</p>	
AXI2025	<p data-bbox="261 1211 482 1232">Green Instrument Guard</p> <p data-bbox="261 1245 747 1287">Solid green, vented instrument tip protectors. Measures 2.8mm x 19mm.</p>	
AXI3238	<p data-bbox="261 1593 475 1614">Clear Instrument Guard</p> <p data-bbox="261 1627 795 1669">Clear, nonvented instrument tip protectors. Measures 3.2mm x 25.4mm.</p>	

PROTECTORS & GUARDS

Item #	Description	Image
AXI5355	<p>Clear Instrument Guard</p> <p>Clear, vented instrument tip protectors. Measures 2mm x 9mm x 25mm.</p>	
AXI5468	<p>Assorted Instrument Guards</p> <p>Assorted colors, vented and solid instrument tip protectors. Various sizes.</p>	
AXI3979	<p>Orange Instrument Guard</p> <p>Orange-tinted, vented instrument tip protectors. Measures 2mm x 9mm x 25mm.</p>	
AXI5047	<p>Orange Instrument Guard</p> <p>Orange-tinted, nonvented instrument tip protectors. Measures 2mm x 9mm x 25mm.</p>	

Cleaning & Sterilizing

DIAMOND KNIFE CLEANING SYSTEMS

Item #	Description	Image
Opti-Kleen		
<p>Accutome recommends the Opti-Kleen blade cleaning system for the care and cleaning of diamond knives. This is an efficient and safe method for cleaning tissue and other debris from the surfaces of diamond knife blades prior to sterilization. The Opti-Kleen blade cleaning system comes with 12 individual disposable trays per dispenser box. A holding tray with cover can also be purchased to cradle the cleaning system trays. The Opti-Kleen blade cleaning system can be used throughout the day for both diamond knives and delicate instruments. Each new instrument should be cleaned in an area of the pad that has not already been used.</p>		
AXII396	<p>Opti-Kleen Blade Cleaning System</p> <p>Each tray has three cleaning sections: a scrubbing section and two rinse sections. Sold 12 individual trays per box. Does not include plastic holder.</p>	
AXII397	<p>Opti-Kleen Holding Tray</p> <p>Plastic holder for disposable cleaning system trays.</p>	

INDICATOR STRIPS

Item #	Description	Image
Biological Indicator Incubator		
<p>3M Attest Incubator provides optimal incubation conditions for the accurate readout of 3M Attest biological indicators. Since the growth of each test organism is temperature dependent, it is critical that the appropriate Attest biological indicator be used with the correct Attest incubator. Biological indicator incubator, 14-vial (round), 56°C steam, 120 nominal voltage required, 90-132V acceptable.</p>		
AXI4154	<p>Biological Indicator Incubator</p>	

INDICATOR STRIPS

Item #	Description	Image
--------	-------------	-------

Biological Indicator Test Pack

Complete biological indicator test packs that includes everything needed for the monitoring of the steam sterilization process. For clinics, medical, and veterinary offices. The Centers for Disease Control and Prevention and AAMI recommend a weekly biological indicator challenge of all sterilizers. This is important to help prevent cross-contamination and to protect patients and medical professionals from infection that can result from a faulty sterilizer or its incorrect operation.

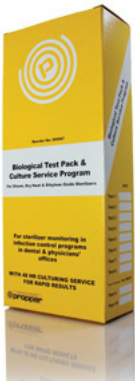
AXI2069	<p>Biological Test Pack and Culture Service Program</p> <p>Test results are uploaded daily to a secure online database and you will be provided a permanent record of test results. Spore testing is one of the most dependable methods to monitor sterilization. This is a complete system that includes a culture service program. Each box contains 10 test packs, 10 sterilization report forms, 10 pre-addressed postage paid envelopes and instructions for use. Takes 48 hours for culturing service. Sold 10 tests per box.</p>	
---------	--	---

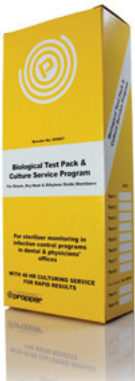

AXI5689	<p>Biological Indicator Test Pack</p> <p>The 3M Attest incubator provides optimal incubation conditions for the accurate readout of 3M Attest biological indicators. Biological indicator incubator, 14-vial (round), 56°C steam, 120 nominal voltage required, 90-132V acceptable. Kit includes: incubator, 1 roll tape, 1 box biological indicators, 1 bag chemical indicators, the log book, inservice video, and wall chart. Sterilization is indicated with color change and takes 48 hours for test results. Latex-free.</p>	
---------	---	---



Biological Indicator Vial

Various brand biological indicators provide the best assurance of sterility by challenging the steam sterilizer with quantifiable, highly resistant *Geobacillus stearothermophilus* spores and providing results quickly. Biological indicators are used for load control monitoring, which is the process by which a load is monitored and released based on the result of a biological indicator (BI) in a test pack.

AXI3167	<p>3M Biological Indicator Vial</p> <p>The 3M Attest system provides results within 48 hours. The self-contained BI for 250°F/121°C gravity and 270°F /132°C vacuum-assisted steam cycles consist of a <i>Geobacillus stearothermophilus</i> spore strip, sealed glass ampule with growth medium and a bromocresol purple pH indicator system, brown color-coded cap with holes for sterilant penetration and a filter as a bacterial barrier, and a chemical indicator on the label that changes from rose to brown when processed. After sterilization, the vial is "crushed" to join the growth media with the processed spore strip. The BI is incubated for 48 hours for a visual color change readout. A color change to yellow indicates surviving spores and a positive result. Store at USP controlled room temperature. Sold 25 vials per box.</p>	
---------	---	--



INDICATOR STRIPS

Item #	Description	Image
AXI4267	<p>3M Biological Indicator Vial</p> <p>The 3M Attest system provides results within 24 hours. 3M Attest I261 biological indicators for 270°F/132°C gravity steam cycles. Self-contained BI for 270°F/132°C gravity steam cycles consists of a <i>Geobacillus stearothermophilus</i> spore strip, sealed glass ampule with growth medium and a bromocresol purple pH indicator dye system, blue color-coded cap with holes for sterilant penetration and a filter as a bacterial barrier, and a chemical indicator on the label that changes from rose to brown when processed. After sterilization, the vial is "crushed" to join the growth media with the processed spore strip. The BI is incubated for 24 hours for a visual color change readout. A color change to yellow indicates surviving spores and a positive result. Store at USP controlled room temperature. Latex-free. Sold 100 per box.</p>	
AXI3258	<p>3M Biological Indicator Vial</p> <p>The 3M Attest system includes rapid readout biological indicators, disposable test packs, an auto-reader, and log books. 3M Attest I291 rapid readout biological indicators for 132°C/270°F gravity displacement cycles. Self-contained BI for gravity displacement cycles consisting of a <i>Geobacillus stearothermophilus</i> spore strip, sealed glass ampule with growth medium and dual indicator system, blue color-coded cap with holes for sterilant penetration and a filter as a bacterial barrier, and a chemical indicator on the label that changes from rose to brown when processed. After sterilization, the vial is "crushed" to join the growth media with the processed spore strip. The BI is incubated for 1 hour in the 3M Attest 290 series auto-reader for a fluorescent reading. Note: This product must be used with Cat. No. 290 3M Attest auto-reader. This product is latex-free. Sold 50 per box.</p>	
AXI4475	<p>Ster-All Biological Indicator Vial</p> <p>Ster-All Performance Self-Contained Steam BI is for use in monitoring 60-degree celsius steam sterilization processes. Final readout takes only 24 hours and fits in existing incubators. Latex-free. Sold 25 tests per box.</p>	
AXI4993	<p>Ster-All Biological Indicator Vial</p> <p>Ster-All Performance Self-Contained Steam BI is for use in monitoring 60-degree celsius steam sterilization processes. Final readout takes only 24 hours and fits in existing incubators. Latex-free. Sold 100 tests per box.</p>	

INDICATOR STRIPS

Item #	Description	Image
--------	-------------	-------

AXI5461

ProSpore2 Biological Indicator Vial

ProSpore2 is ideal for in-office validation and monitoring of steam sterilizers. It consists of a paper disk carrier containing *Geobacillus stearothermophilus* spores. The disk is enclosed in a plastic tube along with a glass vial containing media for growing the bacterial spores. Bromocresol purple has been added to assist in detecting spore growth. The outgrowth of spores decreases pH, causing a color change from purple to yellow. A shorter incubation period allows a validated 24-hour result. Includes biological indicators, testing incubator, record-keeping system, and vial crusher. Sold 50 per box.



Class 4 Steam Indicator Strip

These class 4 steam indicator strips have a distinctive, color change feature when exposed to steam sterilization. Ranges in size and colors.

AXI0400

Medline Sterilization Indicator Strip

Class 4 steam indicator strip that measures 4”L x 1.25”W x 1.5”H and has a distinctive, non-reversible color change from blue to black. These strips contain latex, and are for use in gravity and vacuum cycles. Sold 250 per box.

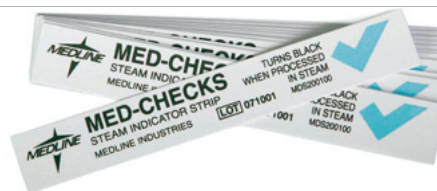

AXI5672

3M Steam Indicator Strip

3M Comply class 4 steam indicator strip that measures 0.625”W x 4.25”L in short form, which is convenient for smaller packs. Has a distinctive color change from yellow to black and can be used in all steam sterilizers. These strips are latex-free and are for use as an internal pack monitor for 250-270°F processes. Sold 250 per box.



AXI3832

3M Steam Indicator Strip

3M Comply class 4 steam indicator strip that measures 0.625”W x 8”L and have a distinctive color change from off-yellow to black. It can be used in all steam sterilizers and is perforated, allowing for full- or half-length use for different pack sizes. These strips are latex-free and are for use as an internal pack monitor. Store at USP controlled room temperature. Sold 240 per box.



AXI4058

Medline Steam Indicator Strip

These measure the time, temperature, and presence of steam in steam sterilizers. They use a distinctive color change from purple to green and are made of laminated plastic. Measures 4” in length and are to be used for Cidex OPA tests. Latex-free. Sold 250 per box.



INDICATOR STRIPS

Item #	Description	Image
--------	-------------	-------

Class 5 Steam Indicator Strip

As an internal pack monitor, the 3M Comply (SteriGage) Class 5 Steam Chemical Integrators offer immediate, accurate and easy to read method of monitoring the sterilization process conditions inside each pack. It can be used in all steam sterilizers. The easy-to-read moving front style has been shown to have a higher reading accuracy than color interpretation style indicators. Use in steam sterilization cycles at 250°F, 270°F, 273°F, and 275°F. Measures 0.75"W x 2"L and are latex-free. Takes 15 minutes, depending on temperature.

AXI3038	3M Steam Indicator Strip Sold 100 per bag.
---------	--

AXI4291	3M Steam Indicator Strips Sold 500 per bag.
---------	---



Dry Heat Sterilization Indicator Strip

Dry heat indicator strip that measures 4" in length and are made from paper. Disposable, nonsterile, latex-free strips. Sold 100 per box.

AXI1042	Dry Heat Indicator Strip
---------	---------------------------------



Indicator Label

Each chemical indicator label provides distinct color change when exposed to the sterilization process. Has date and operator fields on label. Pressure-sensitive indicator for use in dry-heat sterilization processes. Measures 0.75"W x 1.25"L. Sold 125 labels per roll.

AXI5245	Indicator Label
---------	------------------------

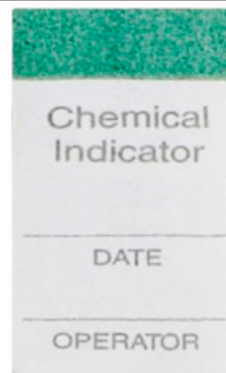

INDICATOR STRIPS

Item #	Description	Image
--------	-------------	-------

OK Steam Sterilization Strip

OK Steam Sterilization Strips are indicators that monitor all critical sterilization parameters: steam, time, and temperature. In sterilization cycles, OK strips guard against incomplete steam penetration, presence of non-condensing gases or excessive air, as well as from inadequate temperature or insufficient time exposure. The pre-printed standard reference color permits rapid and certain visualization of the results. If the sterilization conditions meet requirements, the arrow and the K will change to become at least as dark as the reference color "O" forming the OK expression. The indicator dot printed on the distal end of the 8" strip permits a secure sterile presentation. Only if this dot is dark may sterile personnel handle the strip and the package contents. Without such assurance, contamination of personnel becomes a real risk. For steam sterilization cycles of 250°F (121°C) and 272°F (134°C). Measures 0.56"W x 4"L. Sold 250 per box.

AXI3984 **OK Steam Sterilization Strips**



Steam Indicator Tape

Surgical instrument sterilization tape is used to seal sterilization packs or wraps. The tape will visually indicate that the pack has been exposed to the steam sterilization cycle by its distinctive, non-reversible color change from beige to black. Lead-free ink means no hazardous waste issues. The tape material has a stretchable backing that minimizes tape "pop-off" during sterilization. This tape can also be written on or labeled with pre-printed labels. Sold individually.

AXI3347 **0.94-Inch Steam Indicator Tape**
 3M Comply lead-free steam indicator tape measures 0.94 inch x 60 yards.

AXI5487 **0.70-Inch Steam Indicator Tape**
 3M Comply lead-free steam indicator tape measures 0.70 inch x 60 yards.

AXI5181 **1-Inch Steam Indicator Tape**
 McKesson steam indicator tape measures 1 inch x 60 yards. Contains latex.

AXI1290 **1-Inch Steam Indicator Tape**
 Medline steam indicator tape measures 1 inch x 60 yards. Contains latex.



STERILIZATION POUCHES

Item #	Description	Image
--------	-------------	-------

Dry-Heat Sterilization Pouch

Nylon packaging products are manufactured for use with dry heat processes up to 420°F. Nylon material is clear, strong and puncture resistant, maintaining a durable barrier for instrumentation until point of use. These self-seal nylon pouches feature built-in adhesive tape which eliminates the need for a heat sealer or indicator tape. Each pouch is notched for ease of opening after processing, and complimentary external chemical indicator labels are included. Sold 100 per box.

AXI4271	2" Sterilization Pouch 2" x 10" sterilization pouch.
AXI1038	3" Sterilization Pouch 3" x 10" sterilization pouch.
AXI1013	4" Sterilization Pouch 4" x 10" sterilization pouch.
AXI4457	7" Sterilization Pouch 7" x 10.5" sterilization pouch.
AXI5736	9.5" Sterilization Pouch 9.5" x 13" sterilization pouch.

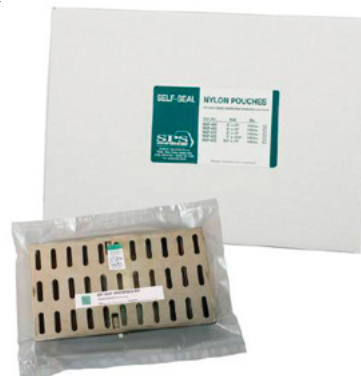

Steam Sterilization Pouch

Various sizes and brands of sterilization pouches. All pouches are transparent for easy viewing and are compatible for EO gas/steam sterilization. Sold 200 per box.

AXI1638	3.5" Sterilization Pouch 3.5" x 5.25" View Pack sterilization pouch. Patented triple seal provides an adhesive-to-adhesive, adhesive-to-paper, and adhesive-to-poly closure for a secure, tamper-free barrier. Triple rail seal offers protection exceeding that of one wide seal, resists blowouts, and provides uniform peel when opening. Blue-tinted laminate helps to quickly detect if a hole or tear is present. Highest quality medical grade paper helps prevent fiber tear of the packaging.
---------	--







AXI3288	3.5" Sterilization Pouch 3.5" x 5.25" Sure-Check sterilization pouch with built-in internal/external multi-parameter steam sterilization indicators confirm all sterilization criteria—time, temperature, and presence of steam. Eliminates the extra step of adding separate multi-parameter indicators to each pouch. Meets CDC infection control guidelines for effective sterilization.
---------	---



STERILIZATION POUCHES

Item #	Description	Image
AXI4229	<p>3.5" Sterilization Pouch</p> <p>3.5" x 8" Steriking sterilization pouch is transparent white in color. This self-sealing pouch is made from a paper/film material. Feature the innovative and convenient chemical indicator (Class I) peel-off strip. The sterilizable adhesive strip promotes a tight, impermeable closing of the pack, while the closing flap is prefolded to facilitate the sealing of the pouch.</p>	
AXI5752	<p>3.5" Sterilization Pouch</p> <p>3.5" x 9" Sure-Check sterilization pouch. This self-sealing pouch is made from a film material with built-in internal/external multi-parameter steam sterilization indicators to confirm all sterilization criteria—time, temperature, and presence of steam. Eliminates the extra step of adding separate multi-parameter indicators to each pouch and meets CDC infection control guidelines for effective sterilization.</p>	
AXI0413	<p>3.5" Sterilization Pouch</p> <p>3.5" x 9" Ster-All sterilization pouch is made from a blue paper/film material. Thumb notch at the fold makes it easy to open and grip. Perforated edge helps to ensure a quality seal. Made of a polypropylene/polyester blend and medical grade paper. Latex-free.</p>	
AXI4487	<p>3.5" Sterilization Pouch</p> <p>3.5" x 9" Medline sterilization pouch. Transparent blue and self-sealing.</p>	

STERILIZATION POUCHES

Item #	Description	Image
AXI5809	<p>3.5" Sterilization Pouch</p> <p>3.5" x 9" View Pack sterilization pouch. Transparent blue and self-sealing. Patented triple seal provides an adhesive-to-adhesive, adhesive-to-paper, and adhesive-to-poly closure for a secure, tamper-free barrier. Triple rail seal offers protection exceeding that of one wide seal, resists blowouts, and provides uniform peel when opening. Blue-tinted laminate helps to quickly detect if a hole or tear is present, and highest quality medical grade paper helps prevent fiber tear of the packaging.</p>	
AXI0155	<p>5.25" Sterilization Pouch</p> <p>5.25" x 10" Ster-All self-seal sterilization pouch is transparent blue in color. This self-sealing pouch is made from a paper/film material and contains a thumb notch at the fold, making it easy to open and grip. Perforated edge helps to ensure a quality seal. Made of a polypropylene/polyester blend and medical grade paper. Latex-free.</p>	
AXI0545	<p>7.5" Sterilization Pouch</p> <p>7.5" x 13" McKesson Argent Sure-Check self-seal sterilization pouch is transparent blue. This self-sealing pouch is made from a paper/film material and helps to ensure infection prevention through proper instrument sterilization, facilitating the safety of both patients and medical staff. Triple seals trap heat along the secured edges to prevent separation. Sterilization pouches maintain sterilization integrity through extra-wide chevron seals. Includes Class 4 or Multi-Parameter Sterilization indicators to help ensure proper saturating steam presence, exposure time, and sufficient high temperatures. Wide self-seal strip and thumb notch make it easy to open. Medical-grade paper eases the labeling process; clear transparent film provides aseptic presentation and easy identification of surgical equipment.</p>	
AXI4173	<p>12" Sterilization Pouch</p> <p>12" x 18" McKesson Argent Sure-Check self-seal sterilization pouch is transparent blue. This self-sealing pouch is made from a paper/film material and helps to ensure infection prevention through proper instrument sterilization, facilitating the safety of both patients and medical staff. Triple seals trap heat along the secured edges to prevent separation. Sterilization pouches maintain sterilization integrity through extra-wide chevron seals. Includes Class 4 or Multi-Parameter Sterilization indicators to help ensure proper saturating steam presence, exposure time, and sufficient high temperatures. Wide self-seal strip and thumb notch make it easy to open. Medical-grade paper eases the labeling process; clear transparent film provides aseptic presentation and easy identification of surgical equipment.</p>	

ULTRASONIC CLEANERS

Item #	Description	Image
--------	-------------	-------

Crest 0.75-Gallon Ultrasonic Cleaner

Crest medical grade 0.75-gallon tank capacity with analog timer and adjustable thermostatically controlled heater. A cover, main on/off switch, and drain valve are all included. All stainless steel enclosures resist chemical spills and will not crack. Has ceramically enhanced transducers and all timers have continuous operation. Dimensions of inside tank: 9.5”L x 5.25”W x 4”H; Overall Dimensions of unit: 11.5”L x 6.375”W x 9.25”H.

AM0940 [0.75-Gallon Ultrasonic Cleaner](#)



Crest 2.5-Gallon Ultrasonic Cleaner

Crest 2.5-gallon tank capacity with analog timer and adjustable thermostatically controlled heater. A cover, main on/off switch, and drain valve are all included. Has a sweep frequency of 45 kHz and all stainless steel enclosures resist chemical spills and will not crack. Has ceramically enhanced transducers and all timers have continuous operation. Dimensions of inside tank: 19.5”L x 5.25”W x 6”H; Overall Dimensions of unit: 20.25”L x 6”W x 10.625”H.

AM0970 [2.5-Gallon Ultrasonic Cleaner](#)



Crest 5-Gallon Ultrasonic Cleaner

Crest 5-gallon tank capacity with analog timer and adjustable thermostatically controlled heater. A cover, main on/off switch, and drain valve are all included. Has a sweep frequency of 45 kHz and all stainless steel enclosures resist chemical spills and will not crack. Has ceramically enhanced transducers and all timers have continuous operation. Dimensions of inside tank: 19.5”L x 11.75”W x 6”H; Overall Dimensions of unit: 21”L x 12.75”W x 14.5”H.

AM0975 [5-Gallon Ultrasonic Cleaner](#)



QUICKRINSE INSTRUMENT RINSE SYSTEM

Item #	Description	Image
--------	-------------	-------

QuickRinse Cleaning System

The QuickRinse instrument rinse system uses pressurized water and air to rinse lumened instruments and tubing, such as phaco handpieces, vitrectomy cutters, and I/A tubing. Unlike with a syringe, the compact system provides consistent rinsing pressure regardless of the operator. The QuickRinse also eliminates hand fatigue associated with repetitive syringe use. Complete system comes with: operator's manual, console, complete bottle assembly, nose cone rinse attachment, dual rinse "Y" attachment, power cord, power supply, accessory fittings, nylon brush, spare bottle cap gaskets, and spare quick-disconnect O-rings.

AM7550 [QuickRinse Cleaning System](#)



Cryo Units

CRYO UNITS

Item #	Description	Image
--------	-------------	-------

Keeler Cryomatic Cryo Unit		
-----------------------------------	--	--

With exceptional reliability, the Cryomatic delivers quality and versatility when using either disposable or reusable probes. The integral software automatically detects the type of probe in use and adjusts the unit accordingly, meaning the unit is ready for use in a matter of minutes. This technology ensures a short purge cycle time after time without the need for an adaptor. Engineered to produce greater reliability and freezing characteristics. Weighs 6 pounds and measures 12"W x 8"D x 7.5"H.

AM9050	Keeler Cryomatic Cryo Unit	
--------	--	--



Pharmaceutical & Diagnostics



4Sight®

Item No. 24-8000

Ophthalmic ultrasound platform that combines the A-Scan, B-Scan, UBM, and Pachymeter in one easy-to-use platform.



A-Scan Plus Connect®

Item No. 24-4400

Portable design and an effective solution for measuring and calculating all of your patients, including dense cataracts, and refining your surgical outcomes.

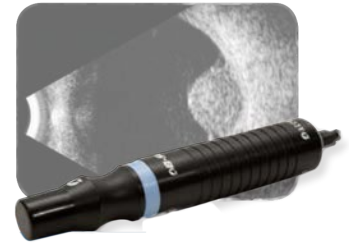

B-Scan Plus®

Item No. 24-6100

Portable probe that provides HD imaging and assessment of the posterior segment, while a user-friendly interface can store and share information easily.



AccuPen®

Item No. 24-3000

Gravity Offset Technology requires less calibration in any testing position while providing up to 9 accurate IOP measurements that can be stored.

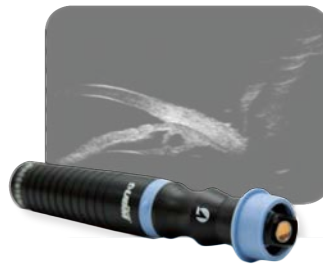

UBM Plus®

Item No. 24-6300

Portable probe that provides HD imaging and assessment of the anterior segment, while a user-friendly interface can store and share information easily.



Pachymeters®

Item No. 24-6200 & No. 24-5100

Accurate and easy-to-use portable or tabletop pachymeter versions that convert IOP measurements in seconds.



Diagnostic Supplies

- Mydriatics/Cycloplegics
- Anesthetics
- Irrigating Solutions
- Gonioscopy
- Tonometry



Therapeutics

- Miotic/Glaucoma Agents
- Antibiotics
- Anti-Inflammatories
- Antibiotic/Anti-Inflammatory Combo



General Ophthalmic Supplies

- Eye Patches
- Punctum Plugs
- Needles and Syringes
- And Many More!

PRODUCT NUMBER LOOKUP

AB-0550S.....	262	AB-2490.....	276	AB-3855.....	282
AB-1000.....	262	AB-2801.....	280	AB-3855S.....	282
AB-1000S.....	262	AB-2804.....	281	AB-3856.....	282
AB-1001.....	263	AB-2805.....	280	AB-3856S.....	282
AB-1052S.....	263	AB-2806.....	270	AB-3857.....	284
AB-1053S.....	265	AB-2807.....	270	AB-4300.....	283
AB-1401.....	263	AB-2808.....	269	AB-4302S.....	283
AB-1401S.....	263	AB-2808S.....	269	AB-4350S.....	282
AB-1402.....	266	AB-2853.....	280	AB-4351.....	283
AB-1403.....	262	AB-2854.....	269	AB-4351S.....	283
AB-1404.....	263	AB-2855.....	268	AB-4352.....	274
AB-1404S.....	263	AB-2856.....	271	AB-4353.....	273
AB-1405.....	265	AB-2859.....	270	AB-4355.....	273
AB-1406.....	263	AB-2860S.....	279	AB-4356.....	274
AB-1406S.....	264	AB-2863.....	272	AB-4357.....	274
AB-1407.....	265	AB-2865.....	271	AB-4359.....	283
AB-1407S.....	266	AB-2890.....	276	AB-4359S.....	283
AB-1410.....	264	AB-3305.....	280	AB-4360.....	284
AB-1410S.....	264	AB-3305S.....	280	AB-5351.....	283
AB-1411.....	271	AB-3353.....	281	AB-8102.....	276
AB-1412.....	272	AB-3354S.....	280	AB-8109.....	275
AB-1421.....	266	AB-3355.....	281	AB-8111.....	276
AB-1452.....	264	AB-3355S.....	281	AB-8112.....	275
AB-1457.....	268	AB-3356.....	280	AB-8117.....	277
AB-1459.....	264	AB-3358S.....	281	AB-8123.....	277
AB-1467.....	278	AB-3361.....	268	AB-8126.....	276
AB-1468S.....	264	AB-3361S.....	268	AB-8127.....	277
AB-1474.....	264	AB-3362S.....	270	AB-8137.....	274
AB-1475.....	265	AB-3363S.....	269	AB-8138.....	277
AB-1476.....	262	AB-3364.....	268	AB-8697G.....	278
AB-1478S.....	262	AB-3364S.....	268	AB-9105B.....	164
AB-1482.....	264	AB-3365.....	267	AB-9110.....	165
AB-2000.....	265	AB-3366.....	281	AB-9110B.....	164
AB-2002.....	265	AB-3370.....	272	AB-9115.....	164
AB-2002S.....	265	AB-3371.....	272	AB-9120.....	165
AB-2003.....	266	AB-3372.....	272	AB-9125P.....	164
AB-2003S.....	266	AB-3373.....	273	AB-9130.....	165
AB-2008.....	279	AB-3374.....	273	AB-9135.....	165
AB-2008S.....	279	AB-3375.....	273	AB-9155P.....	164
AB-2017.....	271	AB-3376.....	272	AB-9160P.....	164
AB-2023.....	278	AB-3377.....	272	AB-9170P.....	164
AB-2023S.....	278	AB-3378.....	273	AB-9175P.....	164
AB-2028.....	266	AB-3379S.....	269	AB-60600.....	256
AB-2054.....	266	AB-3380.....	273	AB-60625.....	256
AB-2056.....	267	AB-3381S.....	270	AB-60650.....	256
AB-2058.....	267	AB-3382.....	269	AB-60675.....	256
AB-2062S.....	279	AB-3382S.....	269	AB-60700.....	256
AB-2063.....	279	AB-3383S.....	271	AB-60725.....	256
AB-2068S.....	279	AB-3386.....	270	AB-60750.....	256
AB-2090.....	275	AB-3391.....	277	AB-60775.....	257
AB-2091.....	276	AB-3801.....	282	AB-60785.....	257
AB-2092.....	276	AB-3801S.....	282	AB-60800.....	257
AB-2455S.....	267	AB-3850S.....	281	AB-60825.....	257
AB-2457S.....	267	AB-3851.....	283	AB-60850.....	257
AB-2461.....	267	AB-3853S.....	270	AB-60875.....	257
AB-2461S.....	267	AB-3854.....	271	AB-60900.....	257
AB-2463.....	268	AB-3854S.....	271	AB-60925.....	257

PRODUCT NUMBER LOOKUP

AB-60950.....	257	AB-AST15G.....	15	AC0231 27.....	80
AB-67600.....	256	AB-AST22.....	13	AC0320 5.....	77
AB-67650.....	256	AB-AST22G.....	15	AC0320 7.....	77
AB-67700.....	256	AB-AST30.....	13	AC0320 8.....	77
AB-67725.....	256	AB-AST45.....	13	AC0320 10.....	77
AB-67750.....	256	AB-AVR10.....	13	AC0350.....	86
AB-67775.....	256	AB-AVR10AG.....	15	AC0390.....	84
AB-67800.....	256	AB-AVR10S.....	13	AC0400.....	85
AB-67825.....	256	AB-AVR12.....	13	AC0457.....	82
AB-67850.....	256	AB-AVR19.....	13	AC0458.....	83
AB-67875.....	256	AB-AVR19A.....	13	AC0459.....	82
AB-67900.....	256	AB-AVR19AG.....	15	AC0460.....	81
AB-ACD26.....	14	AB-AVR19G.....	15	AC0460 23.....	81
AB-ACS20.....	14	AB-AVR20.....	13	AC0461.....	82
AB-ACU26.....	14	AB-AVR20A.....	13	AC0462.....	82
AB-ACU26G.....	16	AB-AVR20AG.....	16	AC0463.....	82
AB-ALRI500G.....	16	AB-AVR20G.....	15	AC0465.....	81
AB-ALRI550G.....	16	AB-AVR21AG.....	16	AC0466.....	83
AB-ALRI600G.....	16	AB-AVR21G.....	16	AC0467.....	82
AB-ARS32.....	14	AB-AVR23A.....	13	AC0469.....	82
AB-ARS35.....	14	AB-AVR23AG.....	16	AC0473.....	83
AB-ARS41.....	14	AB-AVR23G.....	16	AC0475.....	83
AB-ARS52.....	14	AB-AVR25.....	13	AC0476.....	83
AB-ASL10.....	12	AB-AVR25AG.....	16	AC0478.....	83
AB-ASL12.....	12	AB-AVR25G.....	16	AC0485.....	82
AB-ASL18.....	12	AC0105.....	76	AC0560.....	86
AB-ASL18DB.....	12	AC0110.....	76	AC0560 27.....	87
AB-ASL20.....	12	AC0120.....	77	AC0561.....	87
AB-ASL22.....	12	AC0121.....	77	AC0565.....	87
AB-ASL22DB.....	12	AC0122.....	76	AC0566.....	87
AB-ASL22G.....	15	AC0125.....	76	AC0567.....	87
AB-ASL23.....	12	AC0130.....	77	AC0570.....	86
AB-ASL24.....	12	AC0131.....	77	AC0580.....	87
AB-ASL24DB.....	12	AC0140.....	77	AC0582.....	87
AB-ASL24DBG.....	15	AC0141.....	77	AC0583.....	87
AB-ASL24G.....	15	AC0145.....	76	AC0584.....	86
AB-ASL25.....	12	AC0160.....	84	AC0590.....	86
AB-ASL25DB.....	12	AC0190 19.....	76	AC0620.....	78
AB-ASL25G.....	15	AC0190 20.....	76	AC0630.....	78
AB-ASL26.....	12	AC0190 23.....	76	AC0640.....	78
AB-ASL26DB.....	12	AC0190 25.....	76	AC0665.....	84
AB-ASL26G.....	15	AC0190 27.....	76	AC0666.....	84
AB-ASL27.....	12	AC0200.....	87	AC0675.....	84
AB-ASL27DB.....	12	AC0201.....	87	AC0740.....	78
AB-ASL27G.....	15	AC0220.....	80	AC0750.....	78
AB-ASL28.....	12	AC0230 A.....	80	AC0760.....	78
AB-ASL28DB.....	12	AC0230 18.....	79	AC0800.....	79
AB-ASL28G.....	15	AC0230 19.....	79	AC0810.....	79
AB-ASL30.....	13	AC0230 19 CS.....	81	AC0820.....	79
AB-ASL30DB.....	13	AC0230 21.....	79	AC1030 13.....	84
AB-ASL30G.....	15	AC0230 23.....	80	AC1030 21.....	84
AB-ASL32.....	13	AC0230 23 CS.....	81	AC1030 25.....	84
AB-ASL32DB.....	13	AC0230 25.....	80	AC1040.....	88
AB-ASL32G.....	15	AC0230 25 CS.....	81	AC1300.....	85
AB-ASL35.....	13	AC0230 26.....	80	AC1301.....	85
AB-ASL285.....	12	AC0230 27.....	80	AC1305.....	85
AB-AST15.....	13	AC0231 19.....	79	AC2110.....	86

PRODUCT NUMBER LOOKUP

AC2120.....	86	AF0160.....	36	AF1185.....	138
AC2130.....	86	AF0162.....	36	AF1190.....	138
AC2140.....	86	AF0210.....	130	AF1240.....	138
AC2155.....	85	AF0215.....	130	AF1250.....	138
AC2262.....	84	AF0230.....	130	AF1270.....	138
AC2263.....	84	AF0250.....	130	AF1280.....	139
AC4174.....	81	AF0285T.....	139	AF1290.....	139
AC4175.....	81	AF0286.....	139	AF1290TI.....	139
AC5120.....	167	AF0288.....	131	AF1295.....	139
AC5120T.....	168	AF0290.....	132	AF1400.....	155
AC5140.....	168	AF0290 A.....	132	AF1403.....	155
AC5140T.....	168	AF0290K.....	132	AF2100.....	140
AC5141T.....	168	AF0290K T.....	133	AF2105.....	155
AC5150.....	168	AF0290L.....	134	AF2110.....	140
AC5150T.....	169	AF0290M.....	134	AF2120.....	140
AC5151.....	169	AF0290M T.....	134	AF2130.....	140
AC5151T.....	169	AF0290TI.....	133	AF2140.....	140
AC5160.....	169	AF0291.....	140	AF2150.....	141
AC5160T.....	169	AF0292.....	131	AF2320.....	141
AC5170.....	170	AF0295.....	131	AF2360.....	142
AC5170T.....	170	AF0299.....	133	AF2370.....	142
AC5180.....	170	AF0300.....	133	AF2380.....	142
AC5180T.....	170	AF0300 C.....	131	AF2395.....	142
AC5215.....	168	AF0300TI.....	133	AF2400.....	142
AC5220.....	169	AF0310.....	133	AF2405.....	145
AC5220T.....	170	AF0310TI.....	133	AF2440.....	142
AC5235.....	168	AF0340.....	132	AF2450.....	143
AC5235T.....	168	AF0350.....	133	AF2451.....	143
AC5245.....	169	AF0355.....	132	AF2510.....	154
AC5245T.....	169	AF0365T.....	131	AF2520.....	154
AC5400.....	88	AF0400.....	134	AF2540.....	143
AC6540.....	85	AF0410.....	134	AF3145TI.....	150
AC7000.....	166	AF0411.....	134	AF3150.....	145
AC7010.....	166	AF0430.....	134	AF3175.....	150
AC7030.....	165	AF0440.....	135	AF3177TI.....	151
AC7032.....	165	AF0450.....	135	AF3225.....	146
AC7040.....	166	AF0460.....	135	AF3230.....	146
AC7050.....	166	AF0470.....	135	AF3240.....	146
AC7100.....	165	AF0520.....	135	AF3305.....	145
AC7110.....	166	AF0530.....	132	AF3345.....	146
AC7120.....	167	AF0600.....	143	AF3355TI.....	149
AC7130.....	166	AF0700.....	144	AF3360.....	147
AC7430.....	166	AF0750.....	144	AF3370.....	147
AC7431.....	166	AF0800.....	136	AF3390.....	146
AC7450.....	167	AF0801.....	136	AF3480.....	145
AC7451.....	167	AF0810.....	136	AF3540.....	161
AC7530.....	167	AF0820.....	136	AF3600.....	149
AC8000.....	167	AF0830.....	136	AF3700.....	147
AF0100.....	37	AF0840.....	137	AF3705.....	147
AF0120.....	37	AF1110.....	137	AF3710.....	147
AF0120 IN.....	37	AF1110T.....	137	AF3720.....	147
AF0125.....	36	AF1115.....	141	AF3730.....	148
AF0127.....	36	AF1150.....	137	AF3740.....	148
AF0130.....	37	AF1160.....	137	AF3750.....	148
AF0130 I.....	37	AF1170.....	137	AF3760.....	148
AF0140.....	37	AF1180.....	139	AF3765.....	148
AF0145 A.....	38	AF1180TI.....	139	AF3775.....	148

PRODUCT NUMBER LOOKUP

AF4100.....	143	AF6420TI.....	159	AH0620.....	120
AF4110.....	143	AF6421.....	159	AH0630.....	117
AF4120.....	144	AF6424.....	159	AH0630T.....	117
AF4130.....	144	AF6430.....	159	AH0630TI.....	117
AF4310.....	149	AF6450.....	159	AH0640.....	117
AF4320.....	149	AF6455.....	156	AH0650.....	118
AF4400.....	149	AF6470.....	160	AH0660.....	118
AF5100.....	151	AF6530.....	160	AH0670.....	118
AF5110.....	151	AF6580.....	157	AH0675T.....	118
AF5110TI.....	151	AF6700.....	161	AH0680.....	100
AF5140.....	152	AF6710.....	161	AH0690.....	101
AF5150.....	152	AF6720.....	161	AH0695T.....	100
AF5160.....	152	AF6730.....	161	AH0710.....	102
AF5170.....	152	AF6760.....	161	AH0730.....	102
AF5170TI.....	152	AF6770.....	162	AH0740.....	103
AF5180.....	152	AF6780.....	162	AH0750.....	119
AF5180K.....	153	AF6900.....	162	AH0760.....	119
AF5180TI.....	153	AF6910.....	162	AH0770.....	119
AF5190.....	153	AF6920.....	162	AH0780.....	119
AF5200.....	152	AF6930.....	161	AH0790.....	119
AF5200TI.....	152	AF6950.....	142	AH0800.....	120
AF5210.....	153	AF7600.....	150	AH0810.....	121
AF5220.....	153	AF7610.....	150	AH0820.....	121
AF5225.....	153	AF7635.....	150	AH0860.....	99
AF5240.....	154	AF7640TI.....	150	AH0870 C.....	99
AF5270.....	154	AF8000.....	145	AH0880.....	108
AF5290.....	154	AF9050TI.....	149	AH0890.....	108
AF5300.....	151	AF9075.....	144	AH0905.....	114
AF6100.....	155	AH0130.....	90	AH1000.....	234
AF6101.....	155	AH0140.....	94	AH1100.....	114
AF6110.....	155	AH0150.....	94	AH1110.....	104
AF6130.....	156	AH0160.....	94	AH1130.....	116
AF6135.....	155	AH0170.....	94	AH1140.....	99
AF6136.....	155	AH0180.....	94	AH1150.....	103
AF6137.....	155	AH0190.....	94	AH1155.....	103
AF6140.....	156	AH0200.....	94	AH1160.....	103
AF6178.....	141	AH0210.....	94	AH1165.....	103
AF6300.....	156	AH0220.....	90	AH1170.....	104
AF6300TI.....	156	AH0222.....	91	AH1175.....	104
AF6330.....	156	AH0225.....	90	AH1180.....	119
AF6350.....	160	AH0226.....	91	AH1190.....	104
AF6350TI.....	160	AH0228.....	90	AH1190TI.....	104
AF6351.....	157	AH0240.....	90	AH1200.....	104
AF6355.....	160	AH0260.....	198	AH1210.....	104
AF6355T.....	160	AH0300.....	199	AH1510.....	98
AF6360.....	157	AH0305.....	81	AH1520.....	98
AF6370.....	157	AH0510.....	127	AH1530.....	99
AF6380.....	157	AH0520.....	128	AH1530T.....	99
AF6395.....	130	AH0530.....	115	AH1540.....	99
AF6400.....	158	AH0540.....	115	AH1540T.....	99
AF6400 S.....	158	AH0550.....	97	AH1550.....	100
AF6400TI.....	158	AH0560.....	97	AH1560.....	101
AF6404.....	158	AH0580.....	115	AH1570.....	101
AF6410.....	158	AH0590.....	120	AH1580.....	96
AF6410S.....	158	AH0600.....	117	AH1600.....	115
AF6410TI.....	158	AH0605.....	115	AH2100.....	114
AF6420.....	159	AH0610.....	120	AH2110.....	114

PRODUCT NUMBER LOOKUP

AH2120.....	115	AH4182.....	109	AH5255.....	235
AH2130.....	116	AH4184.....	110	AH5256.....	235
AH2135.....	102	AH4184TI.....	110	AH5260.....	234
AH2140.....	116	AH4185T.....	110	AH5265.....	235
AH2150.....	116	AH4190.....	103	AH5267.....	235
AH2160.....	116	AH4195.....	108	AH5270.....	235
AH2190.....	118	AH4200.....	104	AH5275.....	233
AH2210.....	122	AH4205.....	106	AH5290.....	204
AH2230.....	118	AH4205T.....	106	AH5310.....	204
AH2240.....	120	AH4210.....	107	AH5355.....	235
AH2505.....	172	AH4215.....	107	AH5360.....	120
AH2506.....	172	AH4216.....	107	AH5370.....	231
AH2510.....	172	AH4218.....	112	AH5380.....	98
AH2515.....	172	AH4220.....	101	AH5385.....	98
AH2540.....	174	AH4236.....	107	AH5390.....	236
AH2580.....	174	AH4240.....	109	AH5500.....	234
AH2595.....	174	AH4240TI.....	109	AH6110.....	250
AH3110.....	182	AH4242.....	109	AH6120.....	250
AH3130.....	182	AH4242T.....	109	AH6130.....	250
AH3150.....	182	AH4243.....	109	AH6140.....	236
AH3160.....	117	AH4265.....	110	AH6150.....	250
AH3170.....	182	AH4275.....	112	AH6500.....	197
AH3180.....	183	AH4282.....	96	AH6510.....	198
AH3190.....	183	AH4288.....	106	AH6520.....	198
AH3200.....	182	AH4289.....	106	AH6530.....	198
AH3210.....	183	AH4290.....	106	AH6545.....	106
AH3215.....	108	AH4290T.....	106	AH6610.....	232
AH3220.....	183	AH4295.....	106	AH6950.....	119
AH3230.....	183	AH4300.....	101	AH7100T.....	105
AH4100.....	96	AH4345.....	110	AH7101.....	105
AH4100T.....	96	AH4346.....	110	AH7105T.....	105
AH4110.....	96	AH4375.....	109	AH7106T.....	105
AH4115.....	107	AH4376.....	109	AH7107T.....	105
AH4120.....	97	AH4380.....	108	AH7110.....	105
AH4121.....	97	AH4381.....	108	AH7115.....	108
AH4122.....	97	AH4385T.....	109	AH7120.....	114
AH4125.....	97	AH4400.....	110	AH7125.....	100
AH4126.....	112	AH4450.....	96	AH7130.....	107
AH4126T.....	112	AH4600.....	232	AH7200.....	124
AH4135.....	100	AH4605.....	231	AH7201.....	231
AH4140.....	98	AH4606.....	231	AH7202.....	124
AH4140TI.....	98	AH4620.....	232	AH7210.....	91
AH4145.....	108	AH5100.....	230	AH7220.....	124
AH4160.....	102	AH5110.....	233	AH8150.....	232
AH4161.....	102	AH5120.....	230	AK0001L.....	32
AH4170.....	111	AH5124.....	236	AK0002L.....	32
AH4170TI.....	111	AH5125.....	236	AK0003L.....	32
AH4171T.....	110	AH5130.....	230	AK0009.....	33
AH4172T.....	110	AH5140.....	230	AK0010.....	33
AH4173.....	106	AH5150.....	230	AK0011L.....	32
AH4175.....	111	AH5160.....	230	AK0012L.....	32
AH4176.....	111	AH5170.....	233	AK0013L.....	32
AH4177.....	111	AH5190.....	234	AK0018L.....	32
AH4178.....	111	AH5220.....	233	AK0019L.....	32
AH4179.....	111	AH5230.....	233	AK0025.....	32
AH4180.....	111	AH5240.....	234	AK0035.....	33
AH4180T.....	111	AH5250.....	236	AK0038.....	32

PRODUCT NUMBER LOOKUP

AK0041.....	33	AK6160P500.....	28	AK6175SPT500.....	25
AK0060.....	32	AK6160P550.....	28	AK6175SPT550.....	25
AK0061.....	32	AK6160P600.....	28	AK6175SPT600.....	25
AK5002.....	29	AK6160PT200.....	26	AK6180.....	23
AK5003.....	29	AK6160PT250.....	26	AK6216.....	29
AK5004.....	30	AK6160PT300.....	26	AK6230-2.....	23
AK5005.....	29	AK6160PT350.....	26	AK6230-3.....	23
AK5015.....	24	AK6160PT400.....	26	AK6235-2.....	29
AK5017.....	30	AK6160PT450.....	26	AK6235-3.....	29
AK6000-45.....	20	AK6160PT500.....	26	AK6410.....	19
AK6001-45.....	20	AK6160PT550.....	26	AK6411.....	19
AK6002-45.....	20	AK6160PT600.....	26	AK6412.....	19
AK6003-45.....	20	AK6160SPT200.....	26	AK6413.....	19
AK6005-45.....	20	AK6160SPT250.....	26	AK6415.....	19
AK6007S.....	20	AK6160SPT300.....	26	AK6419.....	19
AK6009S.....	20	AK6160SPT350.....	26	AK6424.....	19
AK6010-45.....	21	AK6160SPT400.....	26	AK6427.....	19
AK6011-45.....	21	AK6160SPT450.....	26	AK6449.....	19
AK6012-45.....	21	AK6160SPT500.....	26	AK6450.....	19
AK6013-45.....	21	AK6160SPT550.....	26	AK6451.....	19
AK6015-45.....	21	AK6160SPT600.....	26	AK6452.....	20
AK6016-60.....	24	AK6175.....	24	AK6453.....	20
AK6017S.....	21	AK6175A.....	24	AK6454.....	20
AK6019S.....	21	AK6175P200.....	27	AK6455.....	20
AK6021S.....	21	AK6175P250.....	27	AK6456.....	20
AK6022S.....	21	AK6175P300.....	27	AK6458.....	20
AK6023S.....	20	AK6175P350.....	27	AK6459.....	19
AK6024S.....	21	AK6175P400.....	27	AK6461.....	19
AK6026.....	24	AK6175P450.....	27	AK6465.....	19
AK6030.....	23	AK6175P500.....	27	AL0100.....	243
AK6040.....	22	AK6175P550.....	27	AL0110.....	244
AK6041.....	22	AK6175P600.....	27	AL0120.....	244
AK6044.....	22	AK6175PC.....	27	AL0120 S.....	244
AK6047.....	21	AK6175PT200.....	25	AL0121 S.....	244
AK6050.....	21	AK6175PT250.....	25	AL0126.....	245
AK6051.....	22	AK6175PT300.....	25	AL0130.....	245
AK6052.....	22	AK6175PT350.....	25	AL0133.....	246
AK6053.....	22	AK6175PT400.....	25	AL0140.....	243
AK6054.....	22	AK6175PT450.....	25	AL0140S.....	243
AK6058.....	22	AK6175PT500.....	25	AL0141.....	242
AK6059.....	22	AK6175PT550.....	25	AL0143.....	245
AK6060.....	22	AK6175PT600.....	25	AL0145 H.....	243
AK6064.....	22	AK6175SP200.....	28	AL0150.....	246
AK6065.....	22	AK6175SP250.....	28	AL0151.....	246
AK6067.....	22	AK6175SP300.....	28	AL0152.....	248
AK6070-60.....	21	AK6175SP350.....	28	AL0153.....	247
AK6072.....	21	AK6175SP400.....	28	AL0160.....	246
AK6130.....	23	AK6175SP450.....	28	AL0165.....	246
AK6150.....	24	AK6175SP500.....	28	AL0175.....	247
AK6160.....	24	AK6175SP550.....	28	AL0180.....	245
AK6160A.....	24	AK6175SP600.....	29	AL0185.....	248
AK6160P200.....	28	AK6175SPT200.....	25	AL0190.....	242
AK6160P250.....	28	AK6175SPT250.....	25	AL0300.....	242
AK6160P300.....	28	AK6175SPT300.....	25	AL0301.....	242
AK6160P350.....	28	AK6175SPT350.....	25	AL0340.....	238
AK6160P400.....	28	AK6175SPT400.....	25	AL0390.....	238
AK6160P450.....	28	AK6175SPT450.....	25	AL0400.....	238

PRODUCT NUMBER LOOKUP

AL0450.....	238	AM0127.....	197	AN0140.....	186
AL0470.....	247	AM0128.....	197	AN0145.....	191
AL0480.....	240	AM0330.....	126	AN0150.....	186
AL0490.....	240	AM0330 12.....	126	AN0150TI.....	186
AL0500.....	240	AM0330 13.....	126	AN0160.....	186
AL0520 N/K.....	239	AM0330 14.....	126	AN0160TI.....	187
AL0520 N/V.....	239	AM0330 15.....	126	AN0170.....	191
AL0520 S.....	239	AM0330 16.....	126	AN0170T.....	187
AL0520 T/K.....	239	AM0330 17.....	126	AN0180.....	190
AL0520 T/K TI.....	239	AM0330 18.....	126	AN0180TI.....	190
AL0520 T/V.....	239	AM0330 19.....	126	AN0190.....	190
AL0520 T/V TI.....	239	AM0330 20.....	126	AN0200.....	191
AL0521 S.....	239	AM0330 21.....	126	AN0200TI.....	191
AL0523 T/K.....	240	AM0330 22.....	126	AN0210.....	186
AL0523 T/V.....	240	AM0330 23.....	126	AN0210TI.....	186
AL0525.....	240	AM0330 SET.....	127	AN0220.....	190
AL0530.....	241	AM0410.....	202	AN0230.....	188
AL0533.....	241	AM0410 1.00.....	202	AN0240.....	188
AL0534.....	241	AM0510.....	259	AN0240TI.....	188
AL1100.....	199	AM0560.....	162	AN0250.....	188
AL1110.....	199	AM0570 15.....	258	AN0260.....	191
AL1120.....	199	AM0570 20.....	257	AN0270.....	187
AL1130.....	199	AM0570 25.....	257	AN0280.....	187
AL1280.....	178	AM0570 30.....	257	AN0290.....	187
AL1320.....	176	AM0570 40.....	257	AN0300.....	187
AL1330.....	176	AM0570 45.....	257	AN0300TI.....	187
AL1340.....	176	AM0570 50.....	257	AN0310.....	187
AL1350.....	176	AM0570 60.....	257	AN0320.....	191
AL1360.....	176	AM0570 65.....	257	AN0350TI.....	191
AL1370.....	177	AM0570 67.....	257	AN0400.....	188
AL1375.....	176	AM0570 70.....	258	AN0410.....	188
AL1380.....	177	AM0570 72.....	258	AN0430.....	188
AL1390.....	178	AM0570 75.....	258	AN0440.....	188
AL1400.....	177	AM0570 77.....	258	AN0460.....	189
AL1410.....	178	AM0570 80.....	258	AN0470.....	192
AL1420.....	177	AM0570 82.....	258	AN0480.....	189
AL1430.....	178	AM0570 85.....	258	AN0490.....	192
AL1440.....	178	AM0570 87.....	258	AN0500.....	189
AL1450.....	178	AM0570 90.....	258	AN0510.....	186
AL1460.....	178	AM0570 95.....	258	AN0520.....	192
AL1530.....	177	AM0570 100.....	258	AN0525.....	192
AL2110.....	121	AM0570 105.....	258	AN0540.....	189
AL2120.....	121	AM0570 110.....	258	AN0560.....	192
AL2130.....	121	AM0570 115.....	258	AN0600.....	189
AL2140.....	121	AM0570 140.....	258	AN0610.....	193
AL2150.....	121	AM0570 160.....	258	AN0620.....	189
AL2155.....	121	AM0830.....	36	AN0625.....	192
AL2180.....	122	AM0831.....	36	AN0700.....	193
AL2210.....	122	AM0940.....	343	AR0120.....	41
AL3190.....	241	AM0970.....	343	AR0121.....	41
AL3300.....	122	AM0975.....	343	AR0121TI.....	41
AM0100.....	196	AM7550.....	344	AR0126.....	42
AM0105.....	196	AM9050.....	346	AR0127.....	42
AM0110.....	197	AN0110.....	190	AR0129.....	42
AM0120.....	197	AN0110TI.....	190	AR0132.....	42
AM0125.....	197	AN0120.....	186	AR0140.....	40
AM0126.....	197	AN0130.....	190	AR0145.....	46

PRODUCT NUMBER LOOKUP

AR0146	45	AS0170	208	AS4150	217
AR0148	45	AS0180	207	AS4160	217
AR0150	40	AS0190	208	AS4170	220
AR0150TI	40	AS0200	208	AS4190	218
AR0155	40	AS0210	209	AS4200	218
AR0190	126	AS0220	210	AS4510	220
AR0190TI	126	AS0230	210	AS4520	221
AR0191	126	AS0240	220	AS4530	221
AR0197	126	AS0290	210	AS4540	222
AR0200	126	AS0301	213	AS4550	221
AR0250 4.00	43	AS0310	206	AS4560	221
AR0250 4.50	43	AS0320	207	AS4570	222
AR0250 5.00	43	AS0900	213	AS4575	222
AR0250 5.50	44	AS0940	213	AS4576	222
AR0250 5.75	44	AS1105	207	AS4580	216
AR0250 6.00	44	AS1110	207	AS4590	223
AR0250 8.00	44	AS1115	207	AS4600	223
AR0250 8.5	44	AS1120	207	AS4610	223
AR0250 9.00	44	AS1140	209	AS4620	223
AR0260	40	AS1150	208	AS5100	216
AR0370 2.50	45	AS1160	208	AS5110	215
AR0370 3.00	45	AS1170	209	AS5120	211
AR0370 3.50	45	AS1190	209	AS5130	211
AR0370 4.00	45	AS1200	208	AS5140	212
AR0370 5.00	45	AS1210	209	AS5150	215
AR0370 5.75	45	AS1220	209	AS5160	211
AR0370 6.00	45	AS1270	210	AS5170	212
AR0370 7.00	45	AS1290	210	AS5180	215
AR0370 8.00	45	AS2100	211	AS5190	224
AR0370 9.00	45	AS2110	210	AS5200	224
AR0380	41	AS2120	210	AS5210	225
AR0395	127	AS2310	212	AS5220	224
AR0400 8	44	AS2320	212	AS5235	216
AR0400 12	44	AS2390	212	AS5240	224
AR0420	127	AS3100	213	AS5250	225
AR0430	127	AS3110	213	AS5510	225
AR0580	180	AS3120	214	AS5520	225
AR0585	180	AS3130	214	AS5530	225
AR0600	180	AS3140	215	AS5540	226
AR0602	180	AS3160	214	AS5550	226
AR0603	180	AS3170	215	AS5560	209
AR0605	180	AS3185	214	AS5570	226
AR0610	180	AS3190	214	AS5580	226
AR0616	180	AS3200	215	AS5590	226
AR4120	42	AS3210	215	AS5600	227
AR4130	44	AS3220	215	AS5610	227
AR4150	45	AS3500	218	AS5630	227
AR8000	43	AS3510	218	AS5640	227
AR8001	43	AS3520	219	AS5650	228
AR8002	43	AS3530	219	AS5660	227
AS0100	206	AS3540	219	AS5670	227
AS0110	206	AS3550	219	AS5680	227
AS0120	206	AS4100	214	AS5900	219
AS0130	207	AS4110	214	AS5910	216
AS0140	208	AS4120	217	AS6510	224
AS0150	207	AS4130	220	AS6515	223
AS0160	208	AS4140	217	AS6516	223

PRODUCT NUMBER LOOKUP

AT0155.....	253	AX10830.....	308	AX11750.....	304
AT0160.....	254	AX10836.....	324	AX11774.....	317
AT0170.....	254	AX10852.....	323	AX11795.....	287
AT0170 BTTM MAT.....	254	AX10853.....	48	AX11798.....	317
AT0190.....	253	AX10870.....	324	AX11799.....	317
AT0195.....	253	AX10900.....	325	AX11823.....	291
AT0200.....	253	AX10905.....	296	AX11830.....	319
AT0210.....	253	AX10914.....	49	AX11881.....	318
AT0225.....	253	AX10918.....	318	AX11886.....	307
AT0241.....	252	AX10919.....	295	AX11891.....	60
AT0242.....	252	AX10923.....	290	AX11929.....	306
AT0281.....	252	AX10943.....	318	AX11940.....	301
AT0600.....	254	AX10957.....	322	AX11941.....	301
AT0601.....	254	AX10981.....	318	AX11943.....	293
AX0208.....	288	AX10982.....	318	AX11956.....	52
AX0951.....	307	AX11011.....	298	AX11971.....	294
AX9810.....	297	AX11013.....	340	AX11998.....	315
AX9811.....	297	AX11032.....	309	AX12010.....	311
AX10055.....	299	AX11033.....	305	AX12024.....	324
AX10085.....	315	AX11038.....	340	AX12025.....	331
AX10086.....	315	AX11042.....	338	AX12039.....	293
AX10087.....	315	AX11069.....	324	AX12042.....	307
AX10088.....	315	AX11186.....	324	AX12045.....	48
AX10089.....	315	AX11208.....	331	AX12048.....	323
AX10092.....	316	AX11213.....	299	AX12069.....	335
AX10095.....	300	AX11240.....	301	AX12076.....	286
AX10126.....	295	AX11250.....	288	AX12077.....	287
AX10146.....	302	AX11261.....	51	AX12080.....	52
AX10155.....	342	AX11265.....	317	AX13009.....	317
AX10170.....	294	AX11288.....	330	AX13014.....	66
AX10193.....	313	AX11290.....	339	AX13038.....	338
AX10235.....	317	AX11347.....	310	AX13055.....	298
AX10240.....	290	AX11348.....	60	AX13070.....	196
AX10319.....	294	AX11369.....	318	AX13135.....	324
AX10339.....	294	AX11396.....	334	AX13136.....	324
AX10388.....	289	AX11397.....	334	AX13144.....	278
AX10400.....	337	AX11419.....	310	AX13164.....	303
AX10413.....	341	AX11432.....	321	AX13167.....	335
AX10414.....	48	AX11455.....	325	AX13185.....	306
AX10432.....	304	AX11463.....	52	AX13195.....	298
AX10438.....	298	AX11506.....	306	AX13207.....	302
AX10439.....	298	AX11593.....	290	AX13238.....	331
AX10445.....	311	AX11626.....	321	AX13251.....	291
AX10494.....	311	AX11627.....	322	AX13254.....	51
AX10502.....	292	AX11630.....	53	AX13258.....	336
AX10508.....	303	AX11638.....	340	AX13262.....	292
AX10516.....	316	AX11640.....	293	AX13284.....	286
AX10525.....	309	AX11642.....	288	AX13288.....	340
AX10545.....	342	AX11646.....	321	AX13328.....	287
AX10560.....	308	AX11649.....	322	AX13347.....	339
AX10591.....	303	AX11681.....	319	AX13360.....	297
AX10649.....	68	AX11683.....	318	AX13364.....	287
AX10683.....	325	AX11684.....	320	AX13424.....	308
AX10735.....	288	AX11688.....	320	AX13426.....	293
AX10761.....	59	AX11696.....	304	AX13441.....	307
AX10806.....	330	AX11715.....	320	AX13674.....	305
AX10807.....	331	AX11737.....	323	AX13832.....	337

PRODUCT NUMBER LOOKUP

AX13843.....	296	AX14581.....	48	AX14655.....	50
AX13929.....	196	AX14582.....	48	AX14656.....	50
AX13930.....	196	AX14583.....	49	AX14657.....	50
AX13932.....	330	AX14584.....	49	AX14658.....	50
AX13975.....	325	AX14585.....	49	AX14659.....	50
AX13979.....	332	AX14586.....	49	AX14660.....	50
AX13981.....	295	AX14587.....	49	AX14661.....	50
AX13984.....	339	AX14588.....	49	AX14662.....	50
AX13986.....	300	AX14590.....	49	AX14663.....	50
AX14020.....	313	AX14591.....	50	AX14664.....	50
AX14029.....	196	AX14592.....	49	AX14665.....	54
AX14039.....	274	AX14593.....	49	AX14666.....	54
AX14040.....	274	AX14594.....	50	AX14667.....	54
AX14041.....	275	AX14595.....	53	AX14668.....	54
AX14042.....	275	AX14597.....	53	AX14669.....	54
AX14043.....	275	AX14601.....	53	AX14670.....	54
AX14045.....	277	AX14602.....	53	AX14671.....	54
AX14046.....	277	AX14603.....	53	AX14672.....	54
AX14051.....	289	AX14604.....	53	AX14673.....	54
AX14058.....	337	AX14605.....	52	AX14674.....	54
AX14092.....	319	AX14607.....	52	AX14675.....	54
AX14105.....	306	AX14611.....	52	AX14676.....	54
AX14112.....	14	AX14613.....	53	AX14677.....	54
AX14116.....	312	AX14614.....	53	AX14678.....	54
AX14137.....	299	AX14615.....	52	AX14679.....	54
AX14139.....	314	AX14617.....	52	AX14680.....	55
AX14154.....	334	AX14619.....	52	AX14681.....	56
AX14173.....	342	AX14621.....	52	AX14682.....	56
AX14179.....	299	AX14623.....	52	AX14683.....	56
AX14189.....	298	AX14624.....	52	AX14684.....	56
AX14191.....	300	AX14625.....	51	AX14685.....	56
AX14229.....	341	AX14627.....	51	AX14686.....	56
AX14249.....	297	AX14628.....	51	AX14687.....	56
AX14250.....	294	AX14629.....	51	AX14688.....	56
AX14262.....	302	AX14630.....	51	AX14689.....	56
AX14267.....	336	AX14631.....	52	AX14690.....	56
AX14271.....	340	AX14632.....	52	AX14691.....	55
AX14280.....	300	AX14633.....	52	AX14692.....	55
AX14287.....	314	AX14634.....	52	AX14693.....	55
AX14291.....	338	AX14635.....	51	AX14694.....	55
AX14343.....	293	AX14636.....	51	AX14695.....	55
AX14348.....	301	AX14637.....	51	AX14696.....	55
AX14349.....	289	AX14638.....	51	AX14697.....	55
AX14425.....	302	AX14639.....	51	AX14698.....	55
AX14457.....	340	AX14640.....	51	AX14699.....	55
AX14460.....	310	AX14641.....	51	AX14700.....	56
AX14475.....	336	AX14642.....	51	AX14701.....	56
AX14487.....	341	AX14643.....	51	AX14702.....	56
AX14488.....	289	AX14644.....	51	AX14703.....	56
AX14510.....	275	AX14645.....	50	AX14704.....	56
AX14533.....	196	AX14646.....	50	AX14705.....	57
AX14568.....	48	AX14647.....	50	AX14706.....	57
AX14571.....	48	AX14648.....	50	AX14707.....	57
AX14572.....	48	AX14651.....	51	AX14708.....	57
AX14576.....	48	AX14652.....	51	AX14710.....	57
AX14577.....	48	AX14653.....	51	AX14711.....	58
AX14580.....	48	AX14654.....	51	AX14713.....	57

PRODUCT NUMBER LOOKUP

AX14714.....	58	AX14819.....	69	AX15161.....	301
AX14715.....	58	AX14820.....	69	AX15167.....	294
AX14719.....	59	AX14821.....	70	AX15181.....	339
AX14720.....	59	AX14822.....	70	AX15190.....	301
AX14721.....	59	AX14824.....	70	AX15194.....	286
AX14722.....	59	AX14825.....	70	AX15227.....	75
AX14723.....	58	AX14826.....	70	AX15229.....	326
AX14724.....	58	AX14827.....	71	AX15230.....	327
AX14725.....	58	AX14828.....	71	AX15245.....	338
AX14726.....	63	AX14829.....	72	AX15249.....	300
AX14727.....	62	AX14830.....	71	AX15314.....	291
AX14728.....	63	AX14831.....	72	AX15324.....	299
AX14730.....	62	AX14832.....	71	AX15325.....	299
AX14731.....	60	AX14833.....	71	AX15329.....	296
AX14732.....	60	AX14834.....	72	AX15346.....	312
AX14735.....	63	AX14835.....	71	AX15355.....	332
AX14736.....	61	AX14836.....	72	AX15372.....	293
AX14737.....	61	AX14837.....	71	AX15390.....	295
AX14739.....	60	AX14838.....	72	AX15402.....	328
AX14742.....	62	AX14839.....	72	AX15429.....	315
AX14743.....	61	AX14840.....	72	AX15430.....	315
AX14745.....	62	AX14841.....	72	AX15435.....	296
AX14749.....	63	AX14843.....	70	AX15461.....	337
AX14751.....	62	AX14844.....	73	AX15468.....	332
AX14752.....	60	AX14845.....	73	AX15487.....	339
AX14753.....	60	AX14846.....	73	AX15490.....	292
AX14754.....	64	AX14847.....	73	AX15553.....	315
AX14755.....	63	AX14848.....	73	AX15555.....	298
AX14756.....	64	AX14849.....	73	AX15581.....	75
AX14757.....	64	AX14850.....	73	AX15590.....	313
AX14758.....	64	AX14851.....	74	AX15630.....	75
AX14759.....	64	AX14852.....	74	AX15635.....	70
AX14760.....	64	AX14853.....	74	AX15636.....	70
AX14763.....	65	AX14855.....	74	AX15643.....	315
AX14764.....	65	AX14889.....	323	AX15644.....	315
AX14765.....	65	AX14906.....	292	AX15672.....	337
AX14766.....	65	AX14908.....	305	AX15689.....	335
AX14767.....	65	AX14910.....	326	AX15723.....	312
AX14772.....	66	AX14964.....	320	AX15736.....	340
AX14773.....	67	AX14965.....	321	AX15752.....	341
AX14775.....	67	AX14968.....	319	AX15809.....	342
AX14776.....	67	AX14993.....	336	AX20001.....	75
AX14777.....	67	AX14994.....	309	AX20001-BULK.....	75
AX14778.....	66	AX15012.....	326	AX111637.....	48
AX14780.....	67	AX15014.....	295	AX111642.....	48
AX14781.....	67	AX15021.....	323	AX115027.....	48
AX14784.....	66	AX15042.....	312	AX121273.....	53
AX14785.....	68	AX15044.....	327	AX121273-BULK.....	53
AX14786.....	68	AX15047.....	332	AX121273A.....	52
AX14802.....	68	AX15052.....	297	AX121273A-BULK.....	52
AX14808.....	68	AX15063.....	327	AX121273D.....	66
AX14809.....	69	AX15106.....	299	AX121274.....	53
AX14810.....	69	AX15112.....	322	AX121276.....	53
AX14811.....	69	AX15118.....	316	AX121276A.....	52
AX14812.....	69	AX15155.....	323	AX121277.....	55
AX14817.....	69	AX15156.....	314	AX121277B.....	51
AX14818.....	69	AX15160.....	300	AX121278.....	53

PRODUCT NUMBER LOOKUP

AX121279A.....	55	AX131610.....	61	AX155075.....	58
AX121280.....	52	AX131610-BULK.....	61	AX161571.....	57
AX121638.....	52	AX131610A.....	61	AX165040.....	65
AX121639.....	52	AX131618.....	62	AX165040-BULK.....	65
AX125029.....	67	AX135004.....	61	AX165041.....	65
AX125037.....	66	AX135042.....	63	AX175005.....	65
AX125037-BULK.....	66	AX135049.....	61	AX175041.....	65
AX125155.....	68	AX135093.....	62	AX205256.....	74
AX125157.....	67	AX135113.....	62	AX721502.....	14
AX125158.....	66	AX151287.....	59	AX721532.....	14
AX125176.....	49	AX151297.....	59		
AX131599.....	60	AX151297-BULK.....	59		

ORDERING

Call toll free 1 (800) 979.2020 US and Canada

(610) 889.0200 International

+31 (0) 485.350300 Europe

Fax: (610) 889.3233

info@accutome.com



Buy Online!

accutome.com



3222 Phoenixville Pike, Building #50 • Malvern, PA 19355 USA
European Office: Simon Homburgstraat 21 • 5431 NN, Cuijk, NL

Distributed by: