

From Eye to Insight

Leica
MICROSYSTEMS



Multidisciplinary Microsurgery Microscope

SEE MORE, SIMPLY

PROvido with FusionOptics



PROvido: SEE MORE, SIMPLY

In the OR optimal outcomes rely on you having the best view of the surgical site at all times. That is why we've created the PROvido next generation multidisciplinary microsurgery microscope. PROvido with premium FusionOptics technology enables you to see more in one fully focused view so you can seamlessly progress through your surgery.

Always focused on your patient

Avoid constantly interrupting surgery to refocus thanks to FusionOptics which provides a high resolution view to the bottom of deep cavities.

Get into the position and get going

Set up quickly and effortlessly, and be sure the microscope remains exactly where you need it due to the lightweight, robust design.

Proceed without limitation

Enjoy the comfort and workflow benefits of adaptable optics and more working space, even when working with long instruments.

ALWAYS FOCUSED ON YOUR PATIENT

Constantly interrupting surgery to refocus is a thing of the past. With bright Xenon light and FusionOptics you simply see more at every moment.

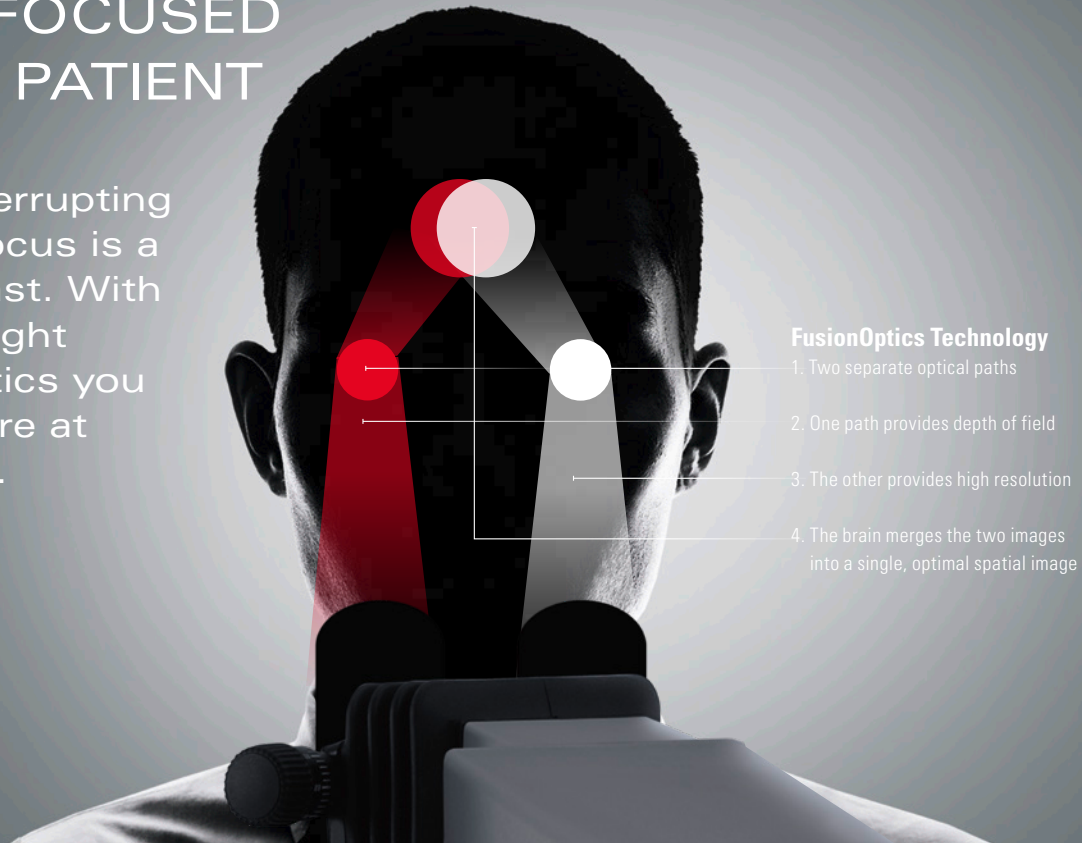

- FusionOptics Technology**
1. Two separate optical paths
 2. One path provides depth of field
 3. The other provides high resolution
 4. The brain merges the two images into a single, optimal spatial image

Seeing more in one view means less refocusing

Refocusing interrupts your procedure. So we've equipped the PROvido with our innovative FusionOptics technology, 300 W xenon light and Small Angle Illumination (SAI). FusionOptics unites high resolution with an increased depth of field for a greatly expanded area in full focus. When coupled with a concentrated xenon light beam, you benefit from a deeper view into cavities with more detail and less shadow.



Magnification multiplier



Rear fine focus

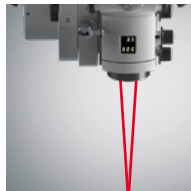

SpeedSpot laser focus

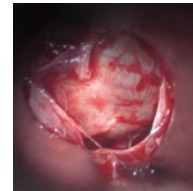

Without SAI

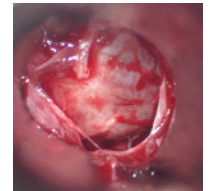

With SAI

The view you need, fast

Meet the visualization needs of your procedure and your team at every moment with optics that are fast to set up and adjust.

- > Start fast with the SpeedSpot system that uses two laser beams as a focusing reference to quickly provide a defined focus point for all three viewing positions (surgeon, assistant, camera)
- > Quickly achieve maximum magnification with the optional Magnification Multiplier that boosts magnification by 40% in an instant
- > Give your opposite assistant viewing flexibility with an independent fine focus

Deeper insights

Small Angle Illumination (SAI) technology and bright 300-Watt xenon light provides a concentrated light beam. You benefit from a bright view with less shadow right down to the bottom of deep, narrow cavities.

GET INTO POSITION & GET GOING

Quickly and effortlessly get into your ideal operating position and start working.



Compact and fully integrated

Take control

Intuitive touch-screen control panel for fast set up of all microscope functions and storage of customized profiles.

- > Flexible intra-operative control of key functions via handgrip or optional wireless foot switch
- > Full integration of HD video camera means that recording and image capture is also just a tap away

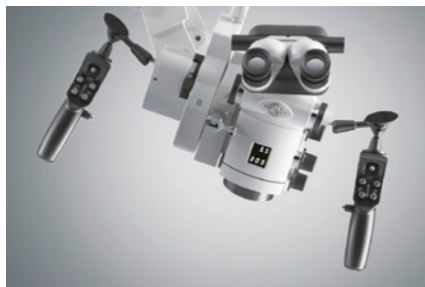

Full range of movement and tilt of the optics carrier

Positioning was never so easy

Positioning the optics carrier is fast and almost effortless. This not only limits strain from harsh movements, but also makes set-up highly efficient.

- > Electromagnetic brakes and AC/BC balancing for effortless, balanced positioning, whatever the required angle
- > Robust, full-metal stand ensures fast stabilization and remains exactly where needed
- > Achieve highly precise micro adjustment with just a touch of the XY joystick control

24" HD monitor and 27" HD touch-screen monitors available

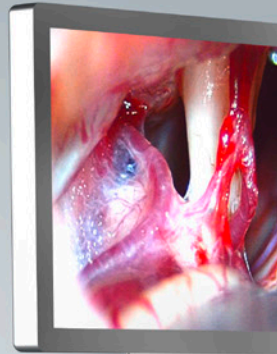

Leica

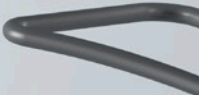



Internally routed cables give a streamlined look and allow for free, unobstructed maneuverability

PROvido

360° rotation

Large free working space between base and optics carrier for positioning flexibility in the OR

More space to work (600 mm)

Compact optics carrier

PROCEED WITHOUT LIMITATION

Enjoy the comfort and workflow benefits of adaptable optics and large working space

Positioned for the comfort of you and your team

- > Arms can remain in a natural position and are not over-extended due to the compact optics carrier design with reduced distance from eyepiece to objective lens
- > Accommodates different operating positions and body frames with a range of binoculars for main surgeon and assistant all with full 360°-rotation
- > The optics carrier is designed to enable your opposite or side assistant to also achieve a comfortable, upright working posture

No restrictions for long instruments

The PROvido offers you positioning flexibility and more space to work whatever the surgery. Class-leading 600 mm working distance is especially advantageous for easy maneuvering and passing of the long instruments typical of spine procedures.

24" HD monitor and 27" HD touch-screen monitors available

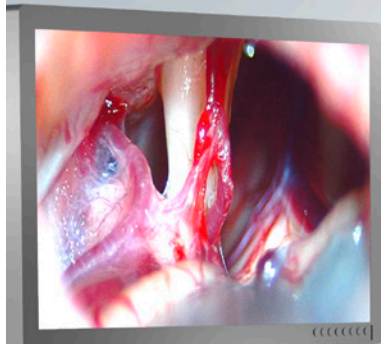

Leica



HELP YOUR TEAM TO SEE MORE

Optimize workflow and learning by sharing your surgery in HD.

A clear view in the OR

Share your view with your team to enhance workflow efficiency and teaching.

- > Stand-mounted monitor arm for flexible positioning
- > 24" HD monitor and 27" HD touch-screen monitor available

Record at the touch of a button

The HD C100 imaging and recording system is fully integrated inside the microscope.

- > Seamless integration allows you to start recording at the touch of a button to capture high definition surgical footage or still images

Share and teach

Easily save surgical images and footage to patient files and share with students to support your teaching program.

- > Simply save to USB or directly to the hospital network via cable for storage in patient files or ready to share with your students

A LEADING LIGHT IN PATIENT SAFETY

Smart illumination minimizes interruption and supports patient safety



Optimal field of illumination

- > Autoliris automatically adjusts the diaphragm in line with the zoom, so as the field of view decreases so does the field of illumination, ensuring that only the visible area is illuminated
- > This prevents the possibility of drying or burning exposed tissue outside the field of view



Optimal light intensity

- > BrightCare Plus automatically adapts light intensity to the working distance for safer illumination (up to 60 % light reduction)
- > An internal luxmeter provides real-time data so light intensity can be measured from actual bulb output
- > Extremely efficient light transmission means that even with less intensity you still have all the light you need

Reliability built in

The PROvido features a bright 300-Watt xenon arc-lamp and back-up 75-Watt LED or 300-Watt xenon arc-lamp with independent lamps and boards. The second illumination system activates automatically if needed, for uninterrupted workflow.

SPECIFICATIONS

OPTICS AND ILLUMINATION

FusionOptics	For increased depth of field and high resolution for main surgeon
Magnification	6:1 zoom, motorized Optional 1.4× magnification multiplier
Focus	Motorized via multifocal lens, with manual adjustment
Objective / working distance	225–600 mm, motorized multifocal lens, continuously adjustable and manual adjustment option
Eyepieces	Wide-field eyepieces for persons wearing glasses 8.3×, 10× dioptic adjustment, ±5 diopter settings and adjustable eyecup
Integrated 360° rotatable adapter	For main surgeon binocular (IVA, ULT) and opposite assistant (ULT)
Illumination	<ul style="list-style-type: none"> - Single Xenon 300-Watt arc-lamp as main illumination with LED lamp as back up or optional dual Xenon arc-lamp illumination system - Continuously variable illumination field diameter - Continuously adjustable brightness at constant color temperature
SpeedSpot	Laser focusing aid for fast and exact positioning of the microscope
Autolris	Built-in automatic zoom-synchronized illumination field diameter, with manual override and reset feature
BrightCare Plus	Safety function through working distance-dependent limitation of the brightness, controlled by built-in luxmeter

CONTROL

Control unit	<ul style="list-style-type: none"> - Programmable touch-screen with user-friendly Graphical User Interface for control of the microscope and stand - Built-in electronic auto-diagnosis and user support - Software independent hard keys for illumination - Indicator for main/backup illumination and fluorescence modes
Control elements	<ul style="list-style-type: none"> - Pistol handle with 10 programmable functions - Optional mouthswitch - Optional 12-function wireless footswitch
IR sensor	For remote control of the external Leica HD C100 camera

OPTIONS

ULT530	<ul style="list-style-type: none"> - Full stereo view for main surgeon and opposite assistant, semi stereo view for 2 side assistants - Optional integrated HD Camera (HD C100)
FL800 ULT	ULT with the Leica FL800 vascular fluorescence observation filter module
FL560	Leica FL560 investigational fluorescence observation filter module
IVA530	<ul style="list-style-type: none"> - Full stereo view for main surgeon, semi stereo view for 2 side assistants and C-mount interface for camera (HD or SD)
Integrated documentation	prepared for integration of video camera system and digital recording. Open architecture

CONSTRUCTION

Base	700 × 700 mm with four 360° rotating castors with a diameter of 126 mm each and integrated brakes
Materials	All solid metal construction coated with antimicrobial paint
Load	Max. 8.5 kg from microscope dovetail ring interface
Weight	Approx. 350 kg without load

MANEUVERABILITY

XY speed	Zoom linked XY speed
Balancing	Manual balancing at microscope carrier and at swing arm
Brakes	Floor stand with 6 electromagnetic brakes
Carrier for monitor	610 mm long and flexible arm with 180° rotation and inclination to carry optional video monitor

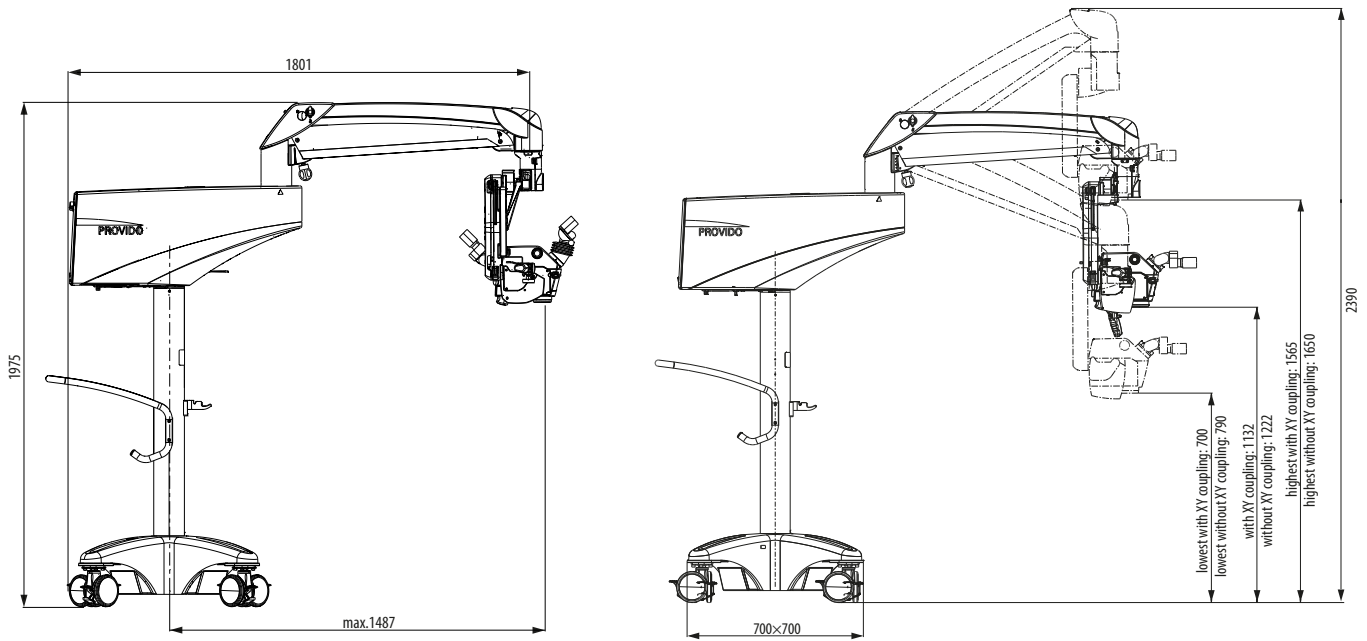

REGULATIONS AND STANDARDS

Class I surgical microscope PROvido incl. accessories

- > Council Directive 93/42/EEC on Medical Devices (MDD) and its amendments.
- > IEC 60601-1 / EN 60601-1 Medical Electrical Equipment, Part 1: General requirements – including national differences of EU, CA, US.
- > IEC 60601-1-2 / EN 60601-1-2 Electromagnetic Compatibility.

The Medical Division, within Leica Microsystems (Schweiz) AG, holds the management system certificate for the international standard ISO 13485 relating to quality management and quality assurance.

The application images used in this brochure were captured with a similar Leica surgical microscope.



CONNECT WITH US!



Leica Microsystems (Schweiz) AG · Max Schmidheiny Strasse 201 · CH-9435 Heerbrugg
 T +41 71 726 3333 · F +41 71 726 3399

www.leica-microsystems.com